

Name	VS40_0174 260x260_40		
Zeichnung/Drawing	3D		
Profil/Profile	4.0x11.4	Datum/Date	28.03.2024

H = 1.700 m  
 TOTAL: 5.38 m<sup>2</sup>

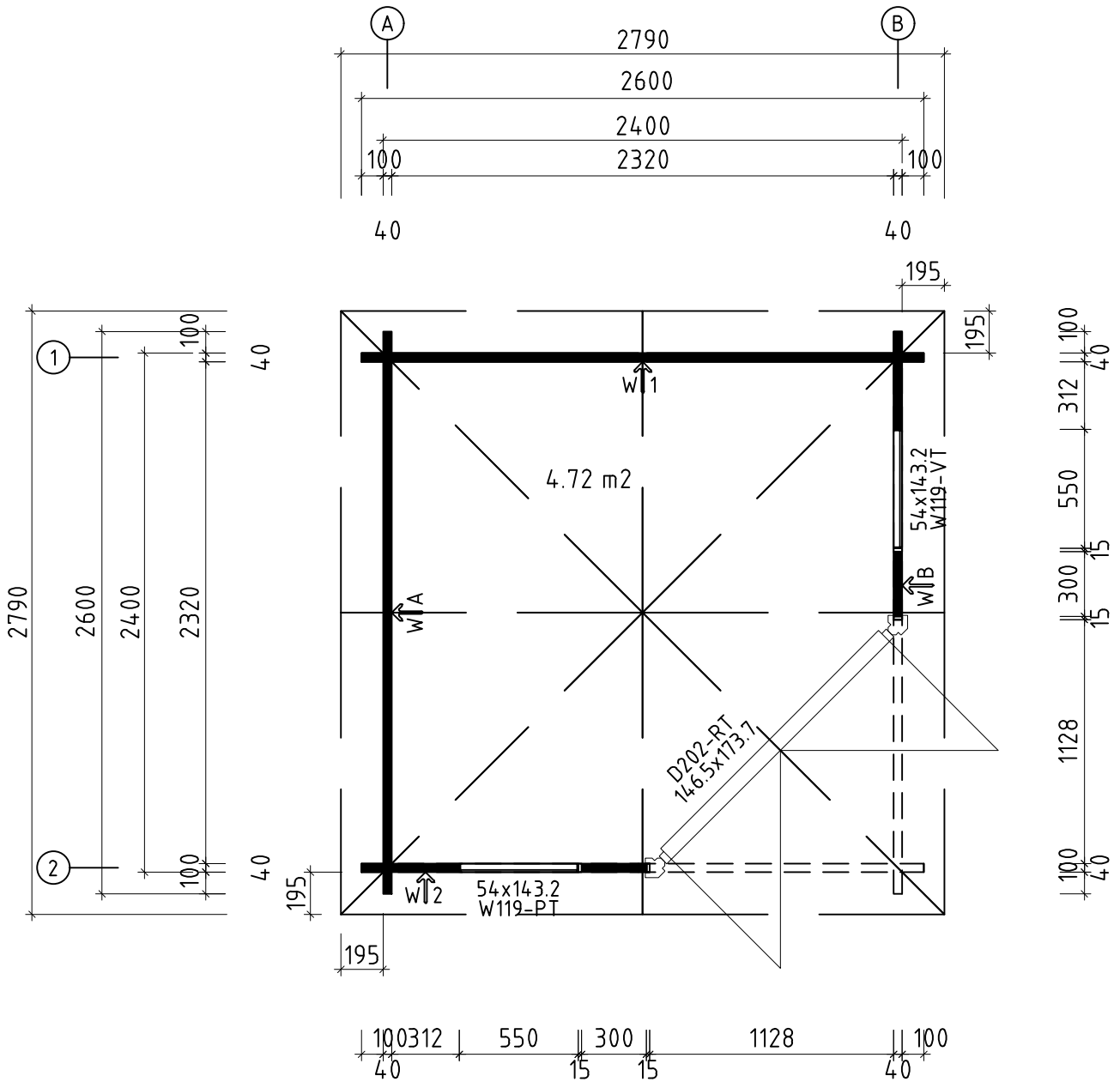



\* Fenster und Türen sind ohne Sprossen  
 Windows and doors are without muntins

Q3 – Qualitätsklasse für Fenster und Türen/  
 Quality class for windows and doors

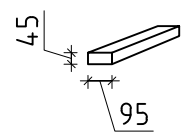
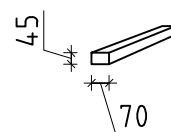
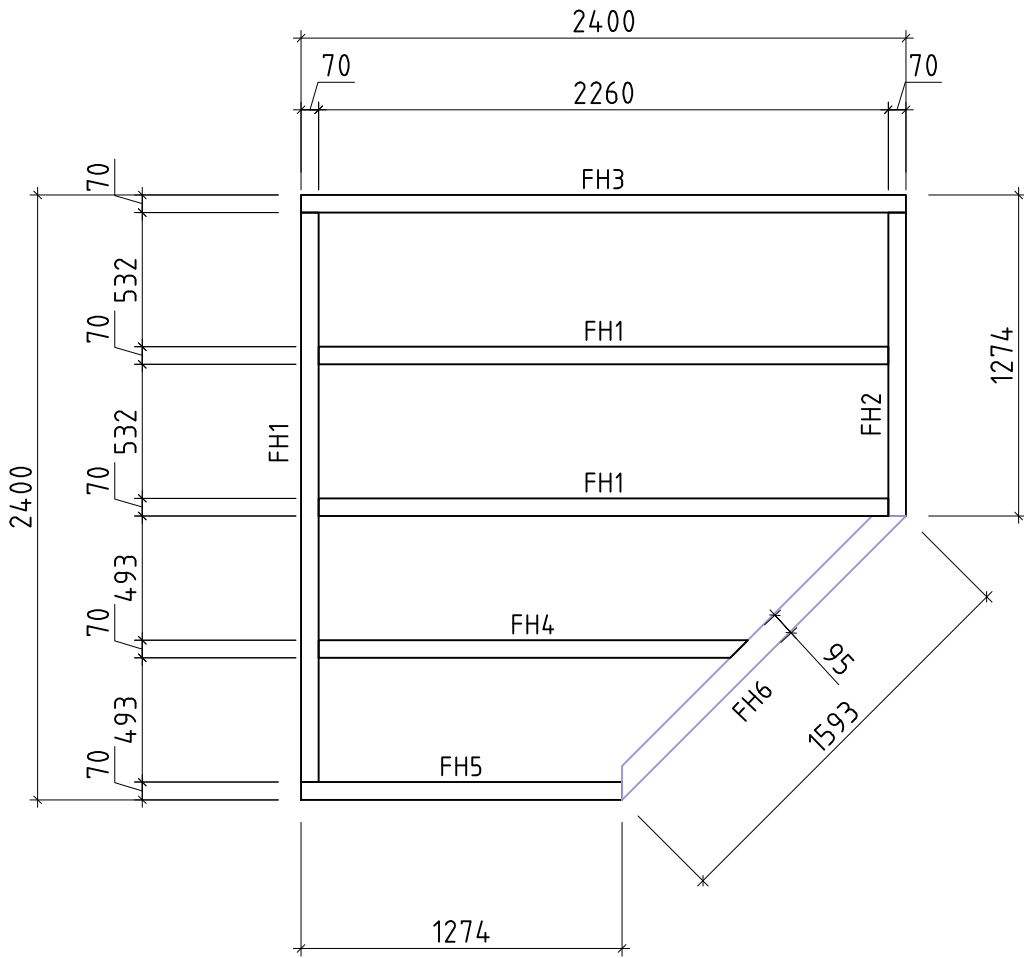
Name	VS40_0174 260x260_40		
Zeichnung/Drawing	Grundplan_Plan		
Profil/Profile	4.0x11.4	Datum/Date	28.03.2024



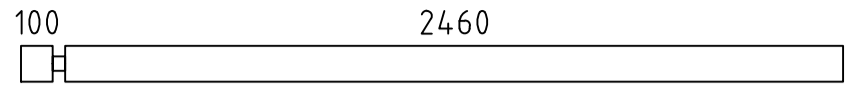
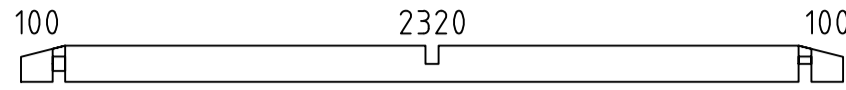
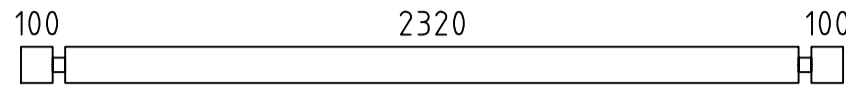
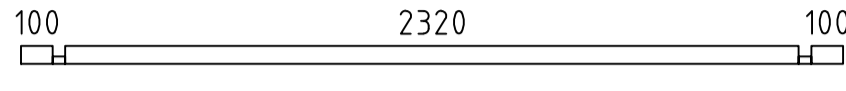
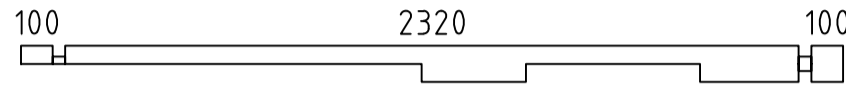
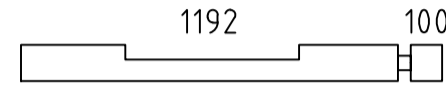
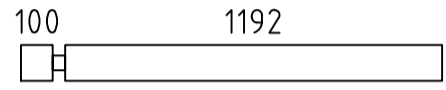
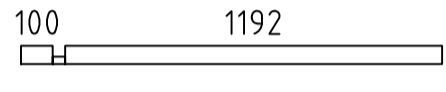
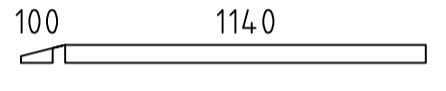
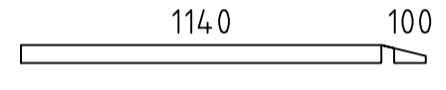
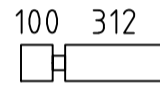
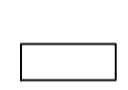

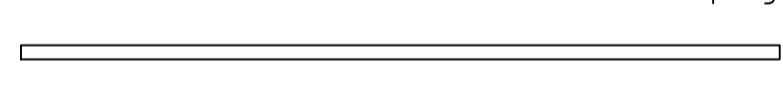
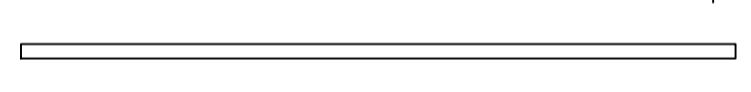
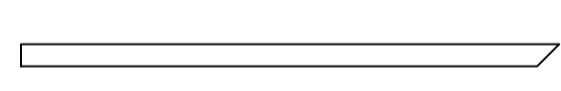
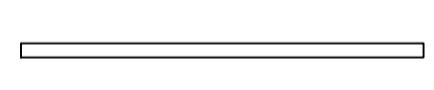
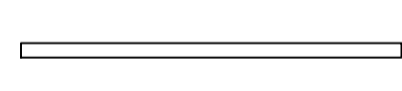
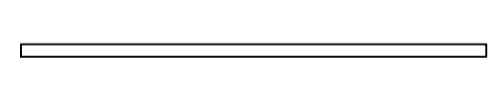
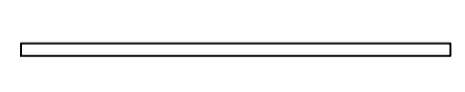
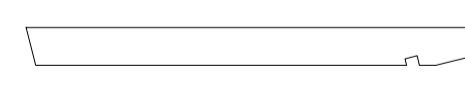
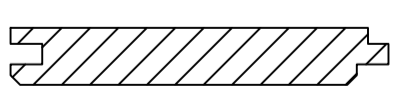
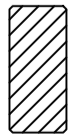
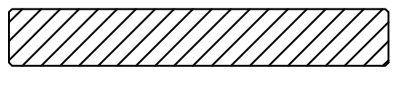
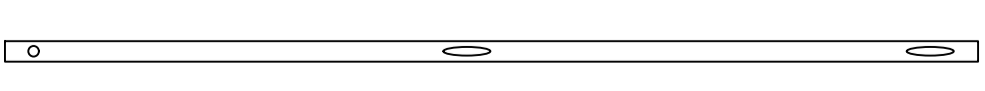

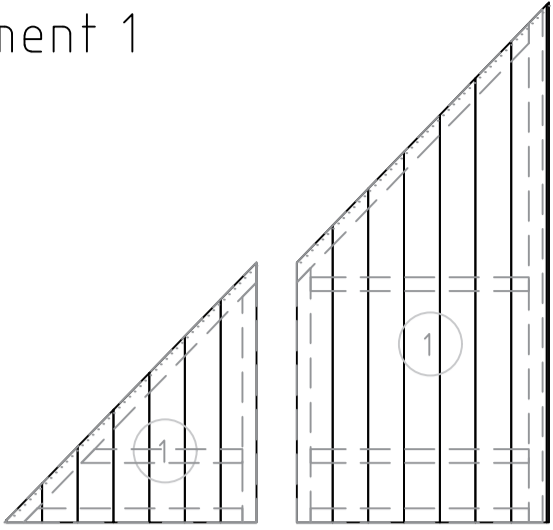
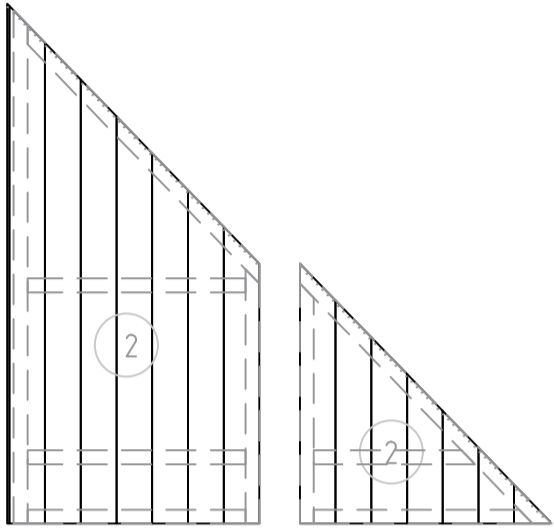
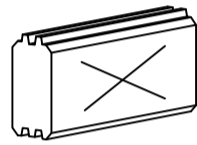
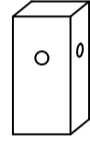
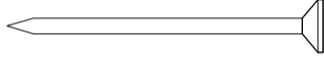
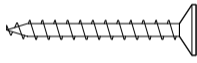
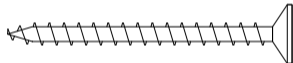
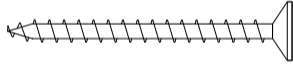
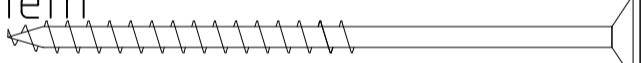
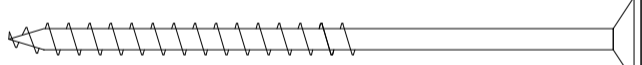
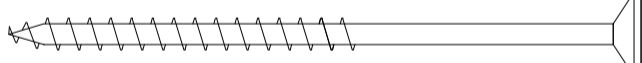
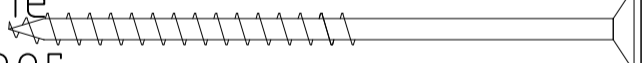
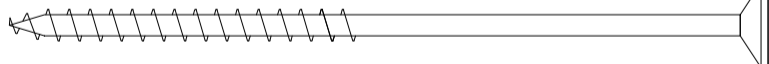
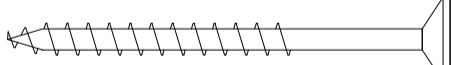
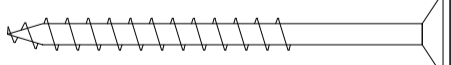
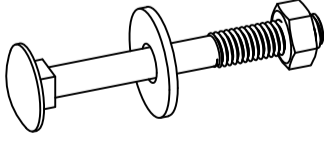



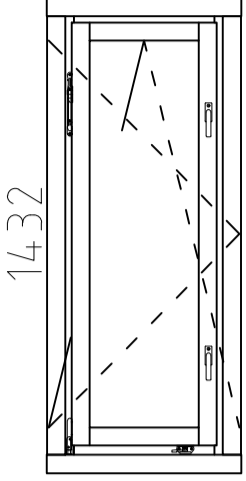
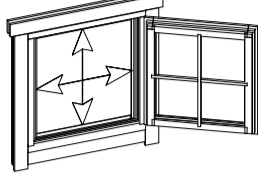
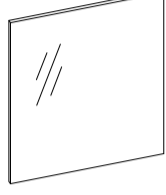

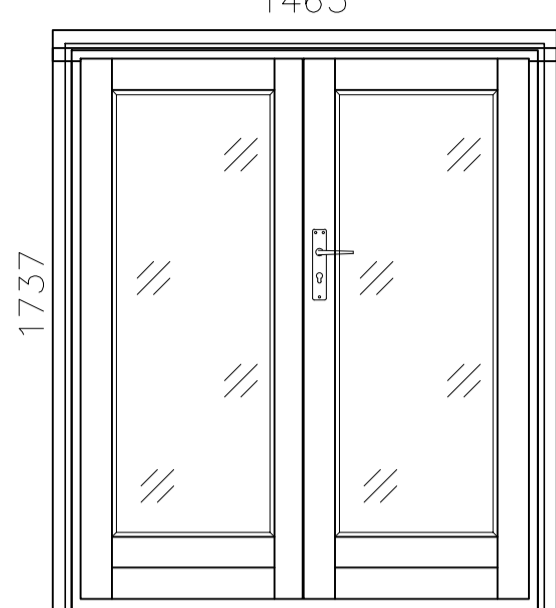
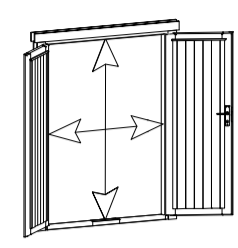
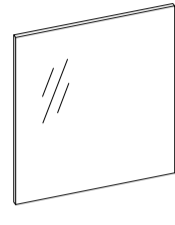

Name	VS40_0174 260x260_40	
Zeichnung/Drawing	Lagerholzplan_Foundation beams	
Profil/Profile	4.0x11.4	Datum/Date 28.03.2024

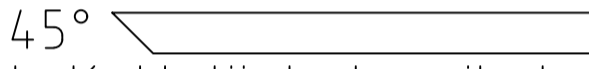
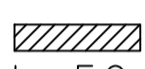
Pos	Teileliste/Specification VS40_0174 260x260_40		Stck Pcs.	Profil Profile (mm)	Länge Length (mm)
1extra			1	40x114	2600
001			2	40x114	2600
002			37	40x114	2600
003			1	40x57	2600
004			1	40x114	2600
005			1	40x114	1332
006			4	40x114	1332
007			1	40x57	1332
008			2	40x57	1280
009			2	40x57	1280
010			25	40x114	452
011			25	40x114	300
FH6	 FUNDAMENTHOLZ (imprägniert) - FOUNDATION BEAM (impregnated)		1	95x45	1585
FH3	 FUNDAMENTHOLZ (imprägniert) - FOUNDATION BEAM (impregnated)		1	70x45	2400
FH1	 FUNDAMENTHOLZ (imprägniert) - FOUNDATION BEAM (impregnated)		3	70x45	2260
FH4	 FUNDAMENTHOLZ (imprägniert) - FOUNDATION BEAM (impregnated)		1	70x45	1702
FH5	 FUNDAMENTHOLZ (imprägniert) - FOUNDATION BEAM (impregnated)		1	70x45	1274
FH2	 FUNDAMENTHOLZ (imprägniert) - FOUNDATION BEAM (impregnated)		1	70x45	1204
LE1	 LEISTE - LATH		2	15x40	1472
LE2	 LEISTE - LATH		2	15x40	1358
SPR1	 SPARREN - RAFTERS		4	40x120	1415
	FUSSBODENBRETTER - FLOOR BOARDS  ✓		21+1	113x18	2315
	FUSSBODENLEISTEN - FLOOR STRIPS  ✓			18x40	10.0 lfm/rm
T02-1	TRAUFENBRETTER - EAVES BOARDS 18x120  ✓		4	18x120	2900
SM-1	Sturmleisten - Storm reinforcement 		4	18x40	1939
Kood	VS40_0174 260x260_40	Materjal		Leht	1/6

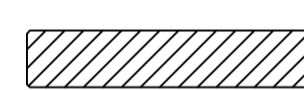
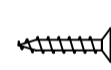
Pos	Teilleiste/Specification VS40_0174 260x260_40	Stck Pcs.	Profil Profile (mm)	Länge Length (mm)
	Dachelement - Roof element 1 	4		
	Dachelement - Roof element 2 	4		
SH	SCHLAGHÖLZER - MOUNTING PIECES 	3		
ZE-1	Zentrale Verbindungselement (Dach) - Central connecting element (rooftop) 	1	44x44	120
NG2 550	NÄGEL - NAILS 2.5x50 Fussbodenbretter - Floor boards 	210		
SR3 030	Schrauben - Screws 3.0x30 Fussbodenleisten - Floor strips 	20		
SR3 545	Schrauben - Screws 3.5x45 Leiste - Lath LE1, LE2 	50		
SR3 545	Schrauben - Screws 3.5x45 Traufenbretter - Eaves boards 	28		
SR57	Schrauben - Screws 5.0x100 Dach element - Roof element 	48		
SR5 0100	Schrauben - Screws 5.0x100 Fundamenthölzer - Foundation beams 	32		
SR5 0100	Schrauben - Screws 5.0x100 Pos - Log 008, 009 	12		
SR5 0100	Schrauben - Screws 5.0x100 Pos 006, 007 1. Bohlenreihe neben die Tür - Log 006, 007 1.row of planks next to Door 	4		
SR58	Schrauben - Screws 5.0x120 Sparren - Rafters 	4		
SR55	Schrauben - Screws 5.0x70 Sparren - Rafters 	4		
SR55	Schrauben - Screws 5.0x70 Dach element - Roof element 	120		
SS024	Schloßschrauben - Wood bolts M8x70 Mutter - Nut M8 U-Scheibe - Washer Ø25 (für Sturmleisten - storm reinforcement) 	12		
	✓ - Bitte selber anpassen (falls nötig)! / Cut into length on site (if needed)!			
Kood	VS40_0174 260x260_40	Materjal		Leht 2/6

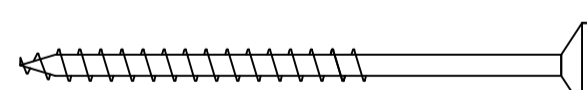

Pos	Teileliste/Specification VS40_0174 260x260_40	Stck Pcs.	Profil Profile (mm)	Länge Length (mm)
	<p>FENSTER/WINDOW 540x1432 W3-S40V-0XT-05401432</p> <p><b>Q3</b> W119-VT 540</p>  <div style="display: flex; justify-content: space-around;"> <div data-bbox="1037 284 1480 365"> <p>Left handed/ DIN links vasakukäeline</p> </div> <div data-bbox="1037 373 1480 543"> <p>Clear opening/ durchgangsmaß/ ava suurus 426x1309mm</p>  </div> <div data-bbox="1037 552 1480 780"> <p>double-pane tempered glass gehärtete ISO Glas 2-fach 2x klaaspakett, karastatud</p>  <p>369x1251mm</p> </div> </div>	1		
WL-1	Rain strips - Wasserleisten - Vihmaliistud 36x134	1	36x134	618
SR40 60-01	4.0x60 Rain strip - Wasserleiste - Vihmaliist	2		
AL-Q 2-Q3	Q2-Q3 Window handle - Fenstergriff - Aknalink	2		
Kood VS40_0174 260x260_40	Materjal		Leht 4/6	

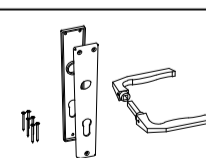
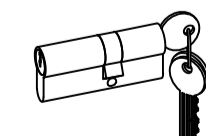
Pos	Teieliste/Specification VS40_0174 260x260_40		Stck Pcs.	Profil Profile (mm)	Länge Length (mm)
	<p>TÜR/DOOR 1465x1737 D3-M40R-0XT-14651737</p> <p><b>Q3</b> D202-RT 1465</p>  <div style="display: flex; justify-content: space-between;"> <div style="width: 45%;"> <p>Right handed / DIN rechts / paremakäeline</p> <p>Clear opening/ durchgangsmaß/ ava suurus 1337x1629mm</p> <p>double-pane tempered glass gehärtete ISO Glas 2-fach 2x klaaspakett, karastatud</p> </div> <div style="width: 45%;">   <p>492x1361mm</p> </div> </div>		1		
DzT40 -01-1	CD- cover strip for door - ET- Deckbrett zum Tür - NU- Katteliist ukse kohale 40		1	18x40	1585
P9L1 -01-1	CD- left hand doorpost - ET- linke Türpfoste - NU- vasak uksepost 40		1	90x90	1777
P9R1 -01-1	CD- right hand doorpost - ET- rechte Türpfoste - NU- parem uksepost 40		1	90x90	1777
VK1- 01-1	CD- trim strips for canopy element - ET- Verkleidungsleisten für Vordachelement - NU- Katteliistud varikatusele 58	  ✓	2	58x18	1110
PL1-1	Trims - Rahmenleisten - Piirdeliistud 18x40	 ✓	1	18x40	1540
PL2-1	Trims - Rahmenleisten - Piirdeliistud 18x58	 ✓	4	18x58	1717
PL3-1	Trims - Rahmenleisten - Piirdeliistud 18x95	 ✓	1	18x95	1540
SR25 15-01	2.5x15 Locking plate - Schließblech - Riivi vastus 01 Q2-Q3		2		
SR35 45-05	3.5x45 Canopy element - Vordachelement - Varikatus		6		
SR35 45-03	3.5x45 Cover strip - Deckbrett - Katteliist ukse kohale		3		
SR35 45-04	3.5x45 Trim strips - Verkleidungsleiste - Katteliist varikatusele		6		
SR35 45-01	3.5x45 Trims - Rahmleisten - Piirdeliistud		24		
SR50 90-01	5.0x90 Door frames - Türrahmen - Ukselengid		8		
VE1-01	CD- canopy element - ET- Vordachelement - NU- Varikatus uksele 1435x745		1		
RV01	Locking plate - Schließblech - Riivi vastus 01 Q2-Q3		1		
UL-Q 2-Q3	Q2-Q3 Door handle - Türgriff - Ukselink		1		
LS-Q4	Q4 Cylinder lock - Zylinderschloss - Lukusüdamik		1		
Kood	VS40_0174 260x260_40	Materjal		Leht	5/6



VS40\_0174 260x260\_40

Zuschneiden der  
Fussbodenbretter 113x18mm

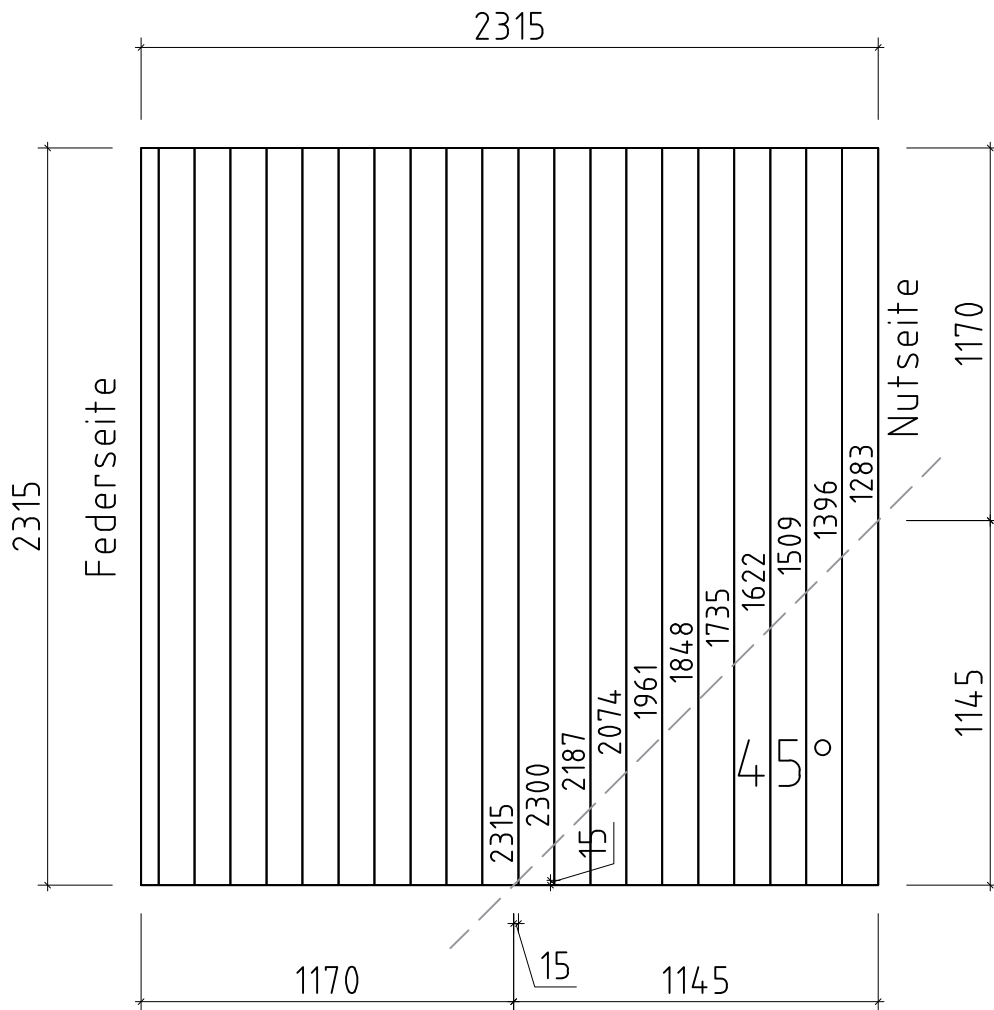

VS40\_0174 260x260\_40

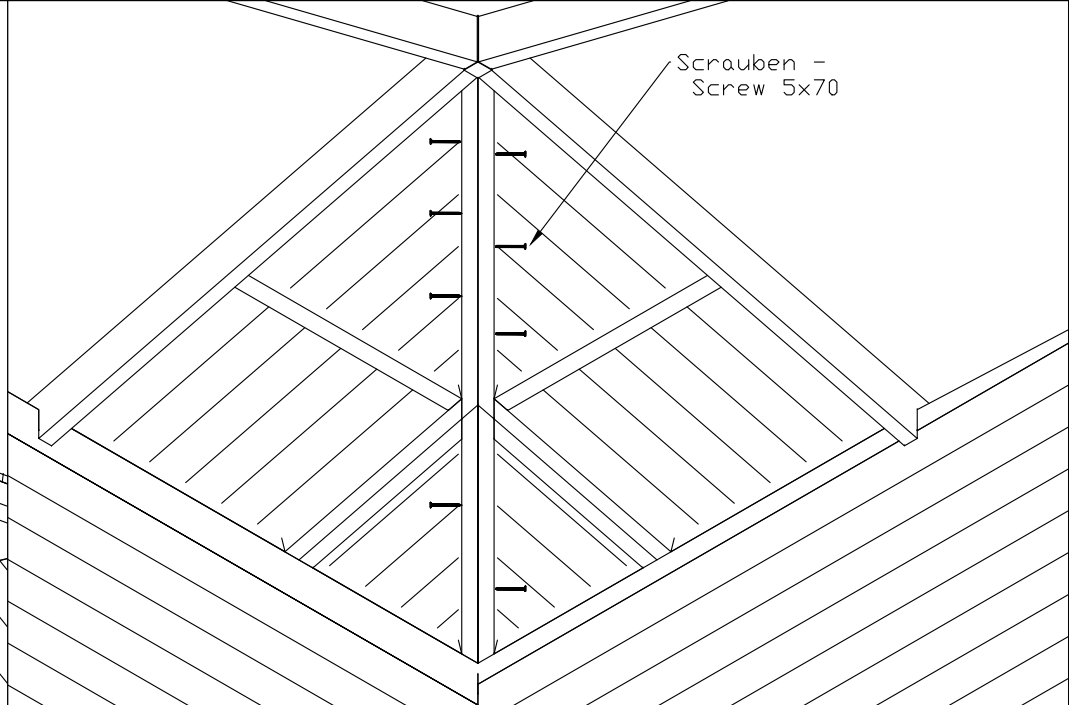
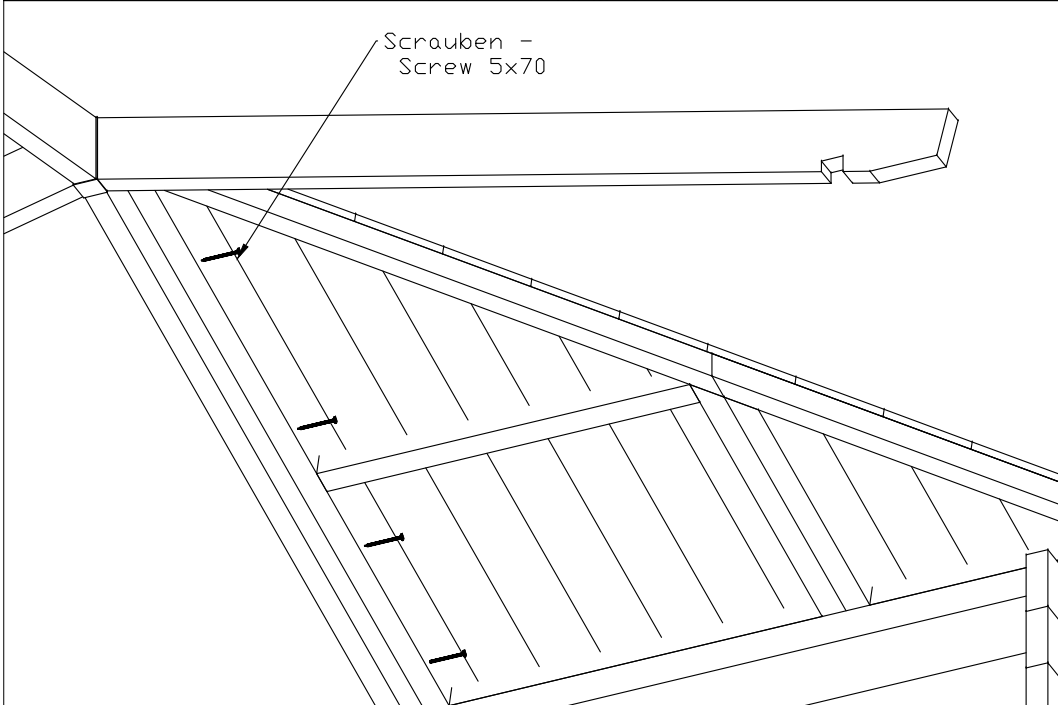
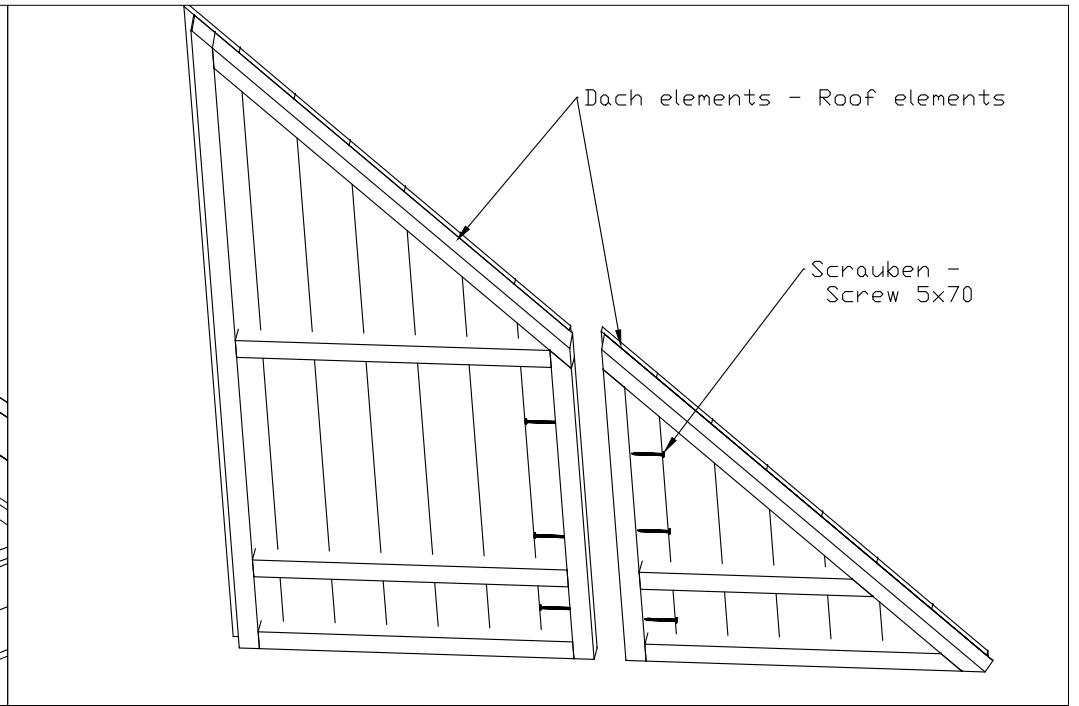
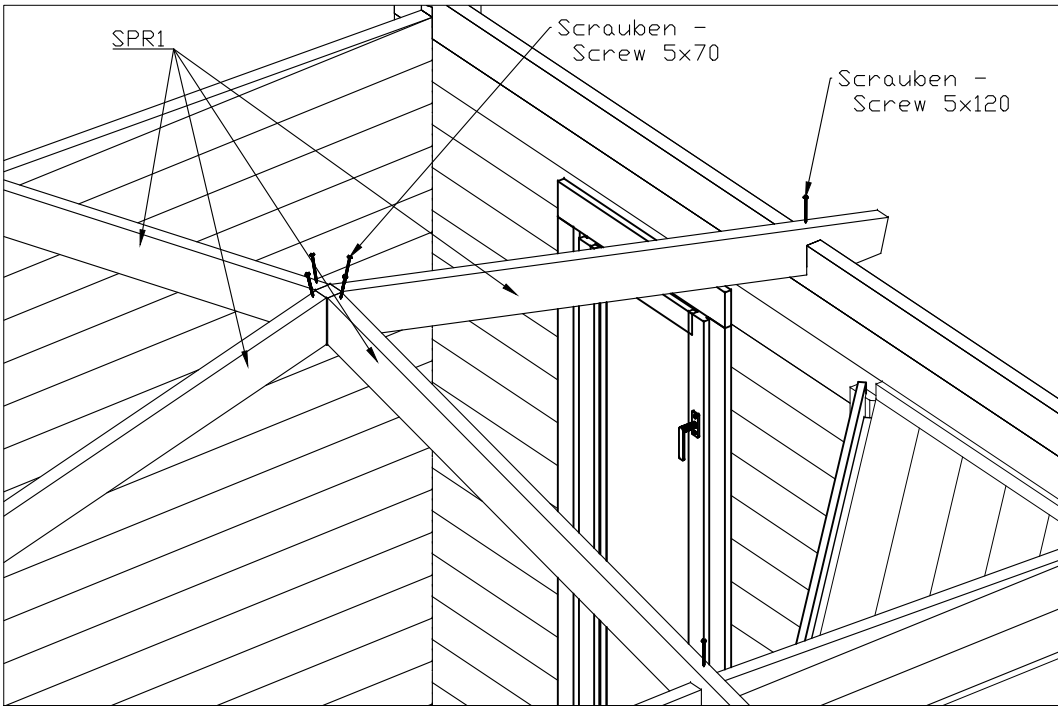

VS40\_0174 260x260\_40

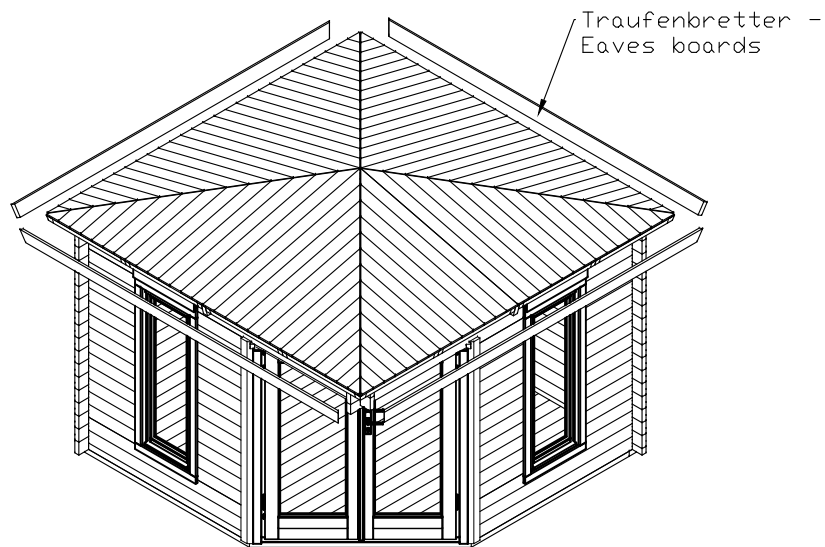
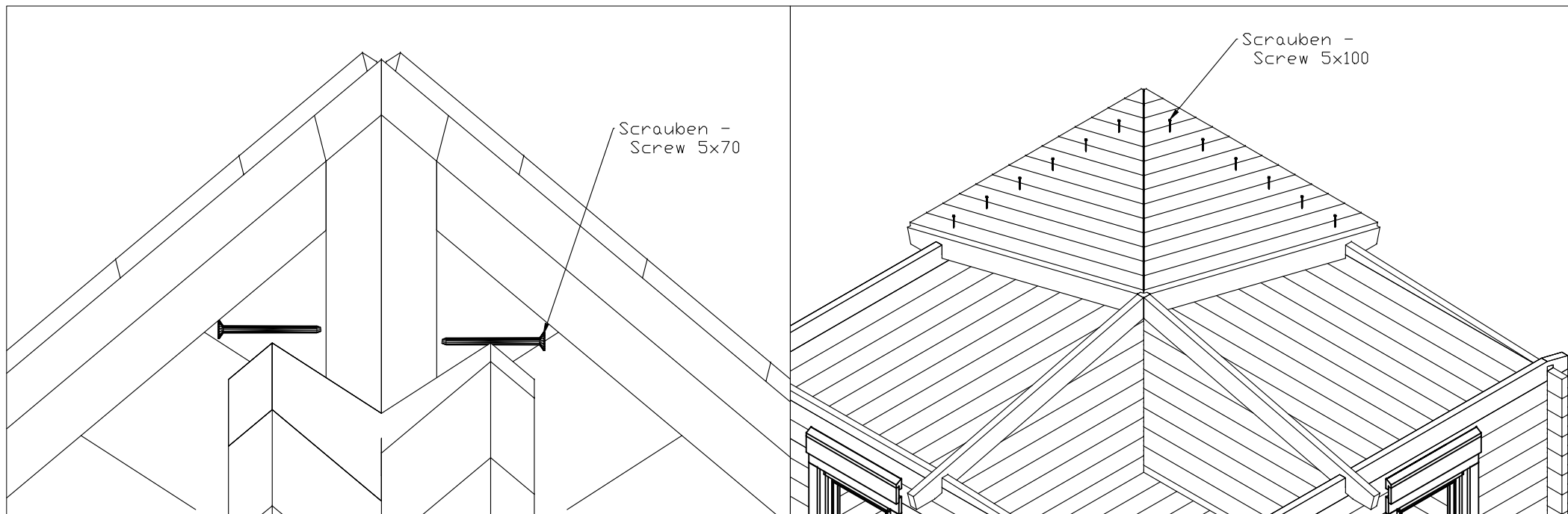

Das Traufenbretter in passende Länge schneiden!

Cut Eaves boards to the appropriate length!

## Vihmaliist / Rain strip / Wasserleiste

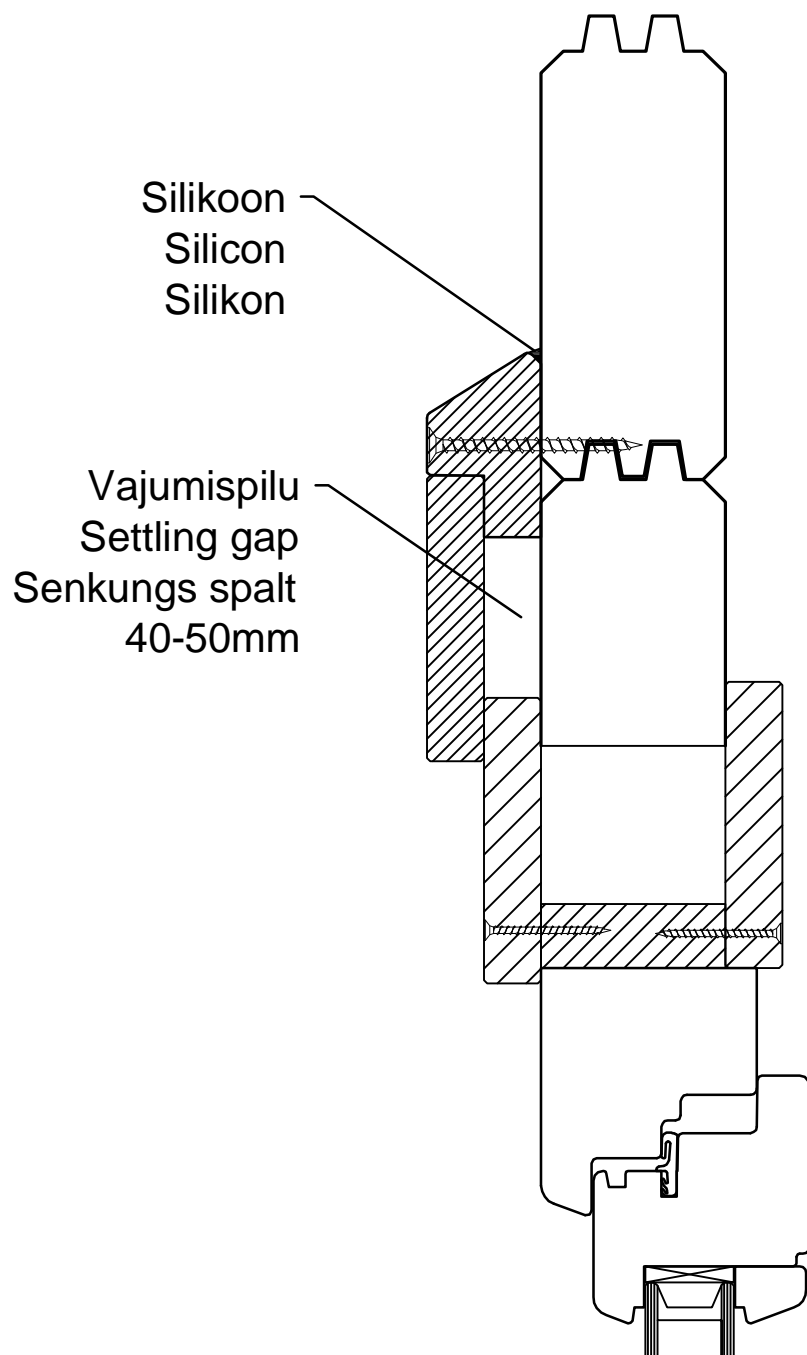

NB!

- Monteerida juhul kui ese on välja toodud maja spetsifikatsioonis!
- Install only if the item is listed in the house specification!
- Nur montieren wenn die Leiste in der Teileliste gezeigt ist!

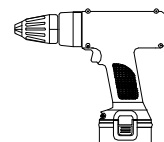

Ukse montaa 0 / Tür montage / Door assembly  
(GH+ / SH)

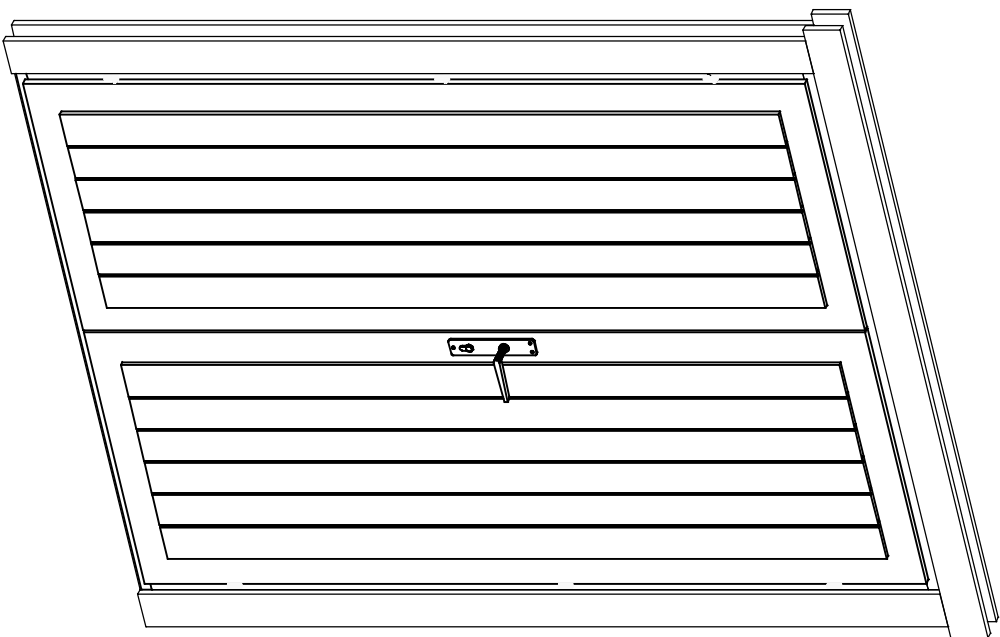

4.5x90



4.5x90



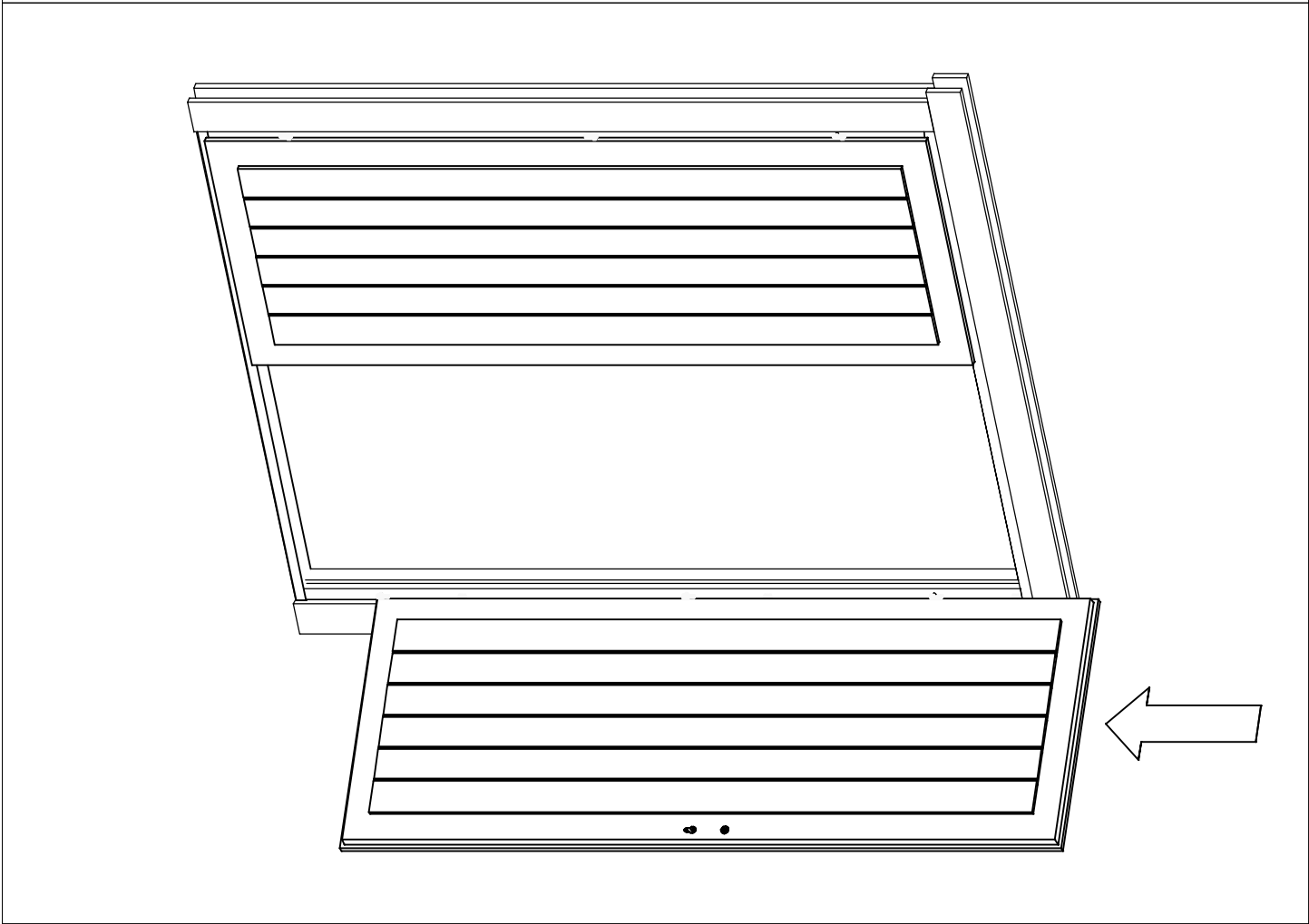
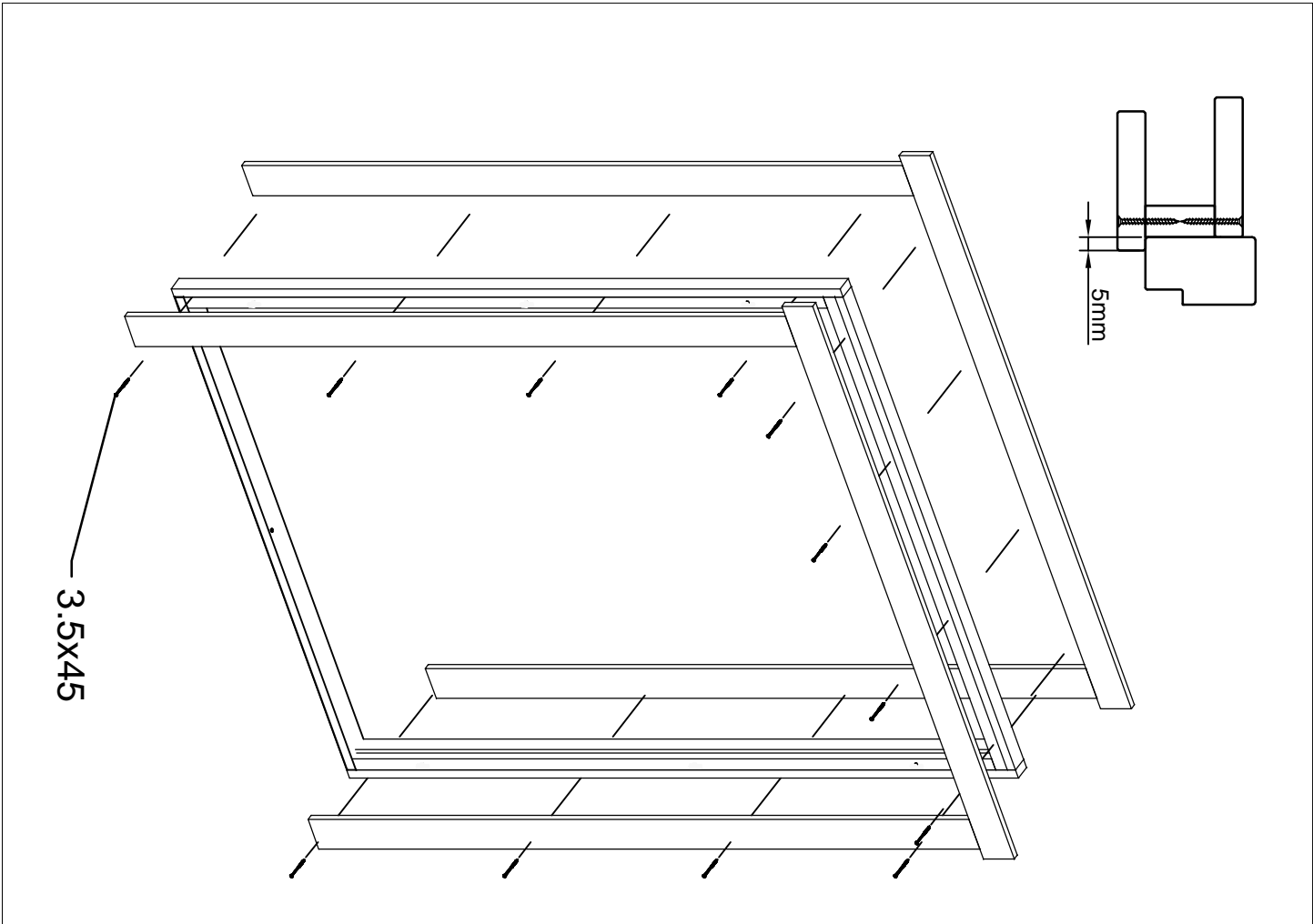

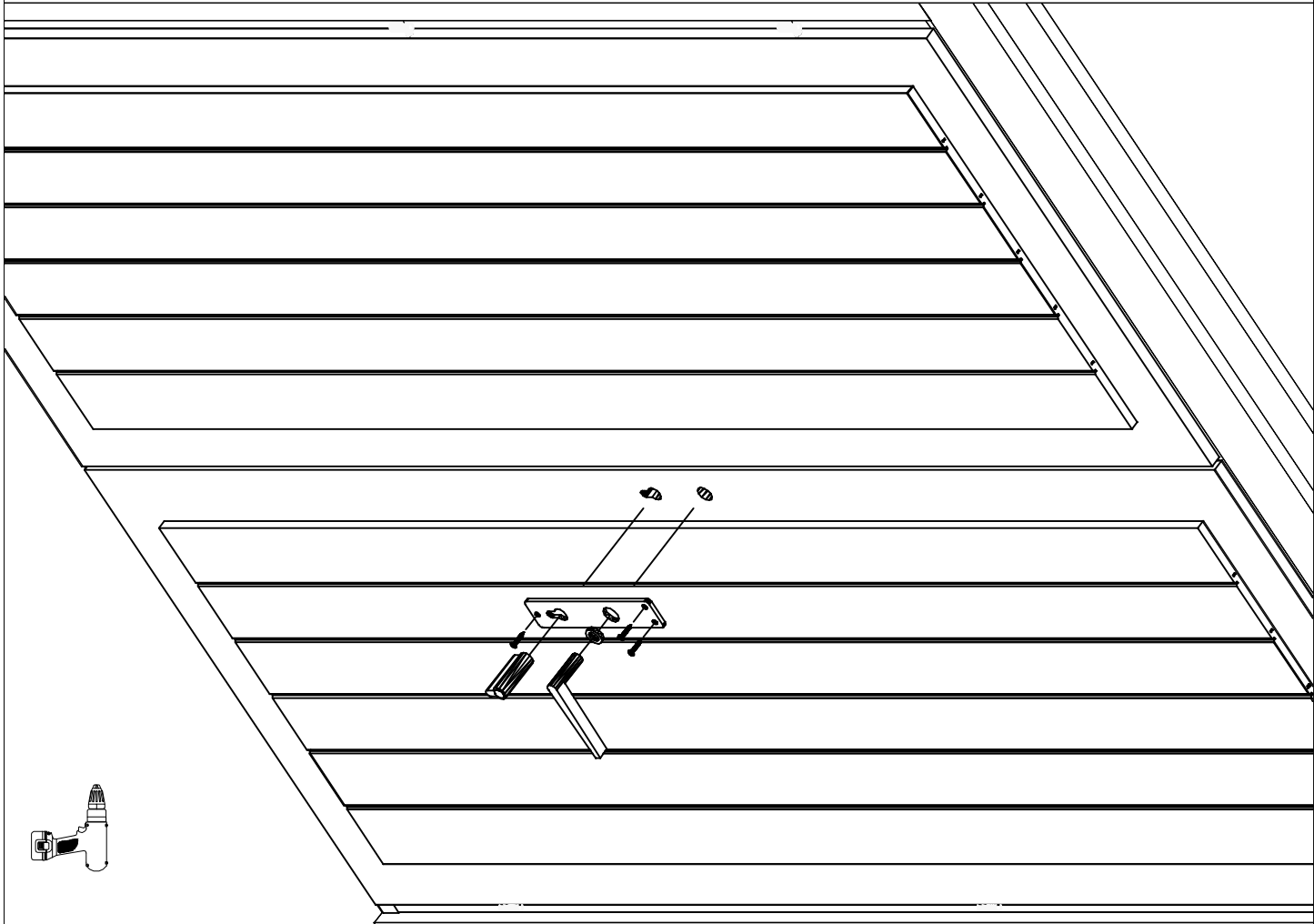
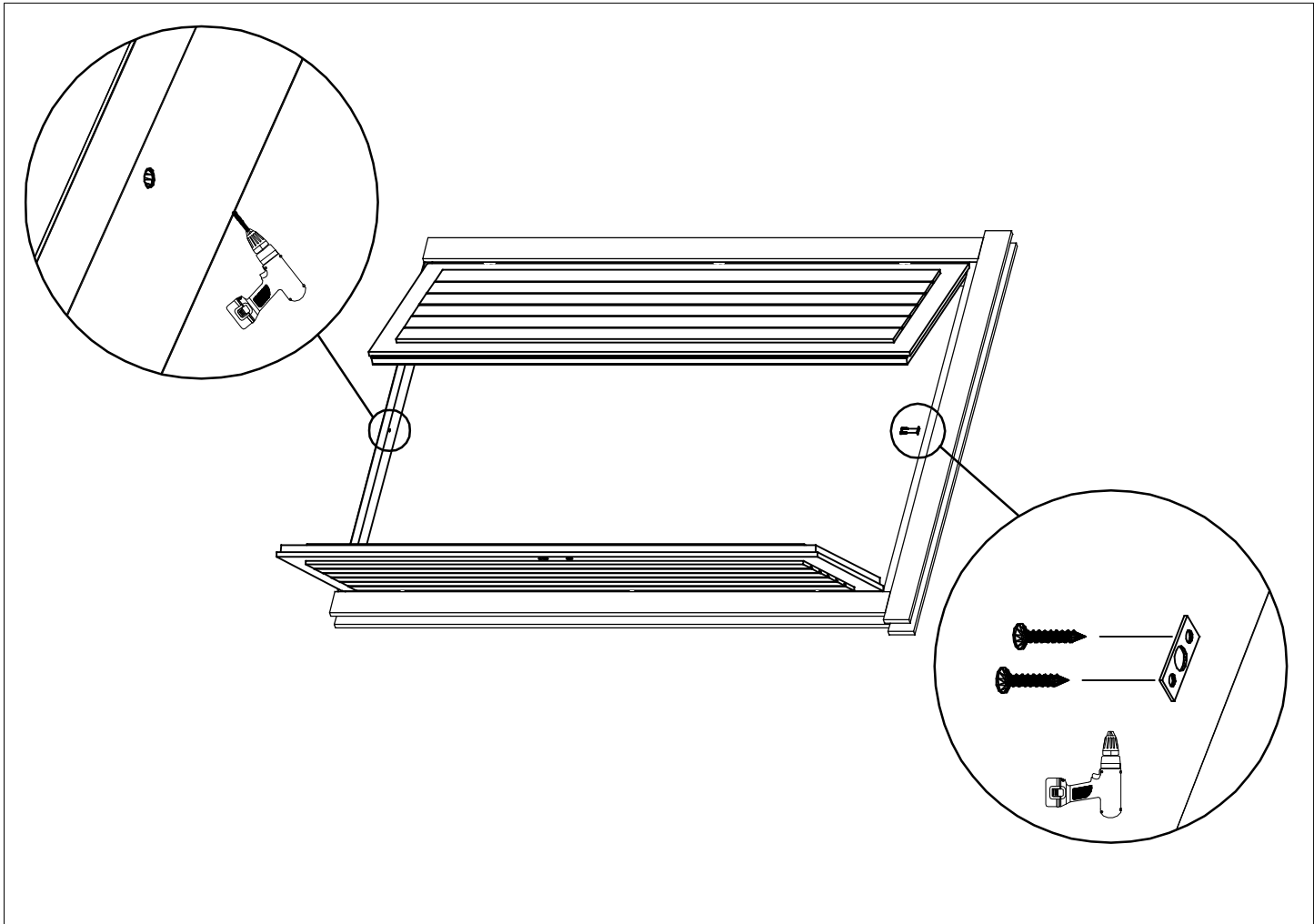

1. samm: Ukse varikatus kinnitada seinale.  
Step 1: Dachelement an den Wänden verschrauben.  
Step 1: Screw canopy element to the wall.

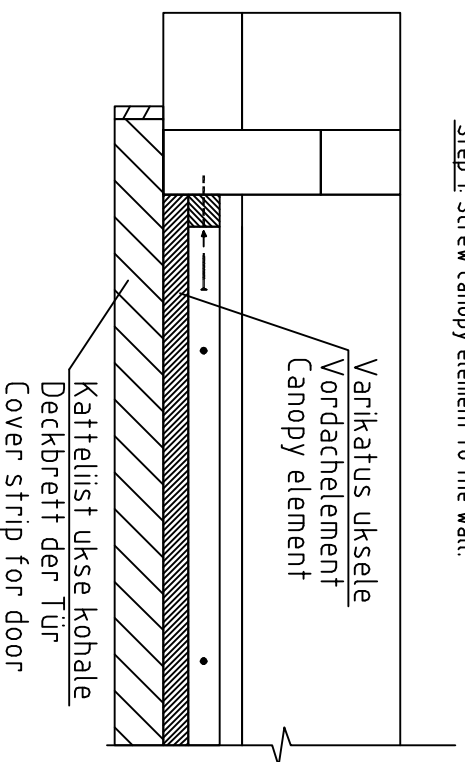

2. samm: Katteliist tuleb kinnitada läbi varikatuse asetusega külgepidi vastu ukseleistu.

- Step 2: Das Deckbreitt muss von oben (durch das VD-Element) an das Dach-element verschraubt werden.  
Step 2: Fasten cover strip to the canopy element.

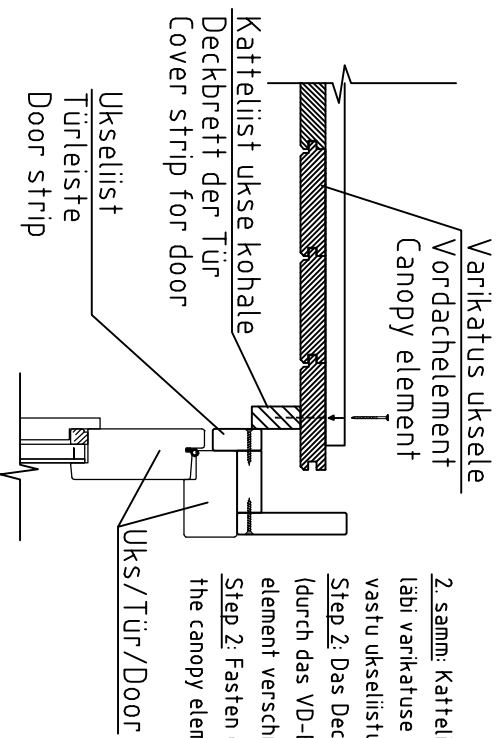

3. samm: Katteliistud tuleb lõigata möötu ja siis paigaldada seinale ja varikatuse ühenduskoha alla.

- Step 3: Die Verkleidungsleisten in die richtige Länge schneiden und unter das VD-Element befestigen.

- Step 3: Cut trim strips to size and fasten under the canopy element.

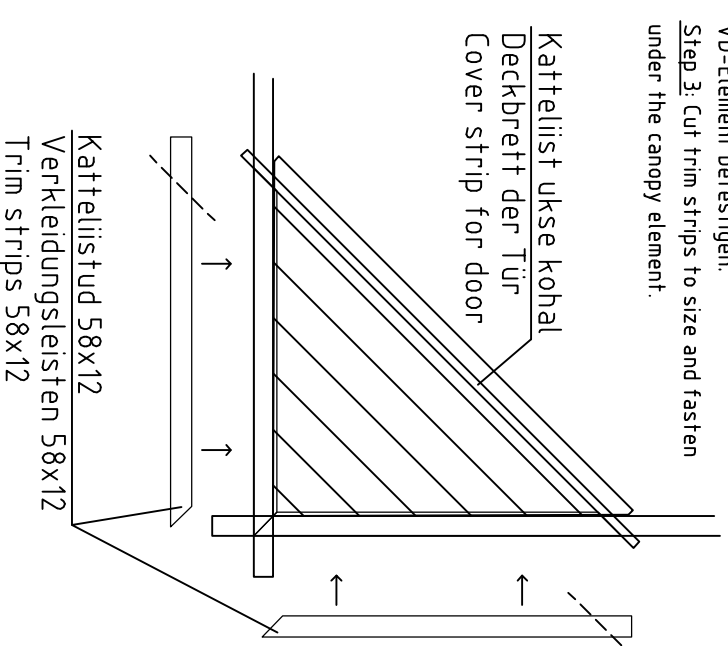

Varikatus uksele/Vordachelement/Canopy element

Lõige/Schnitt/Section



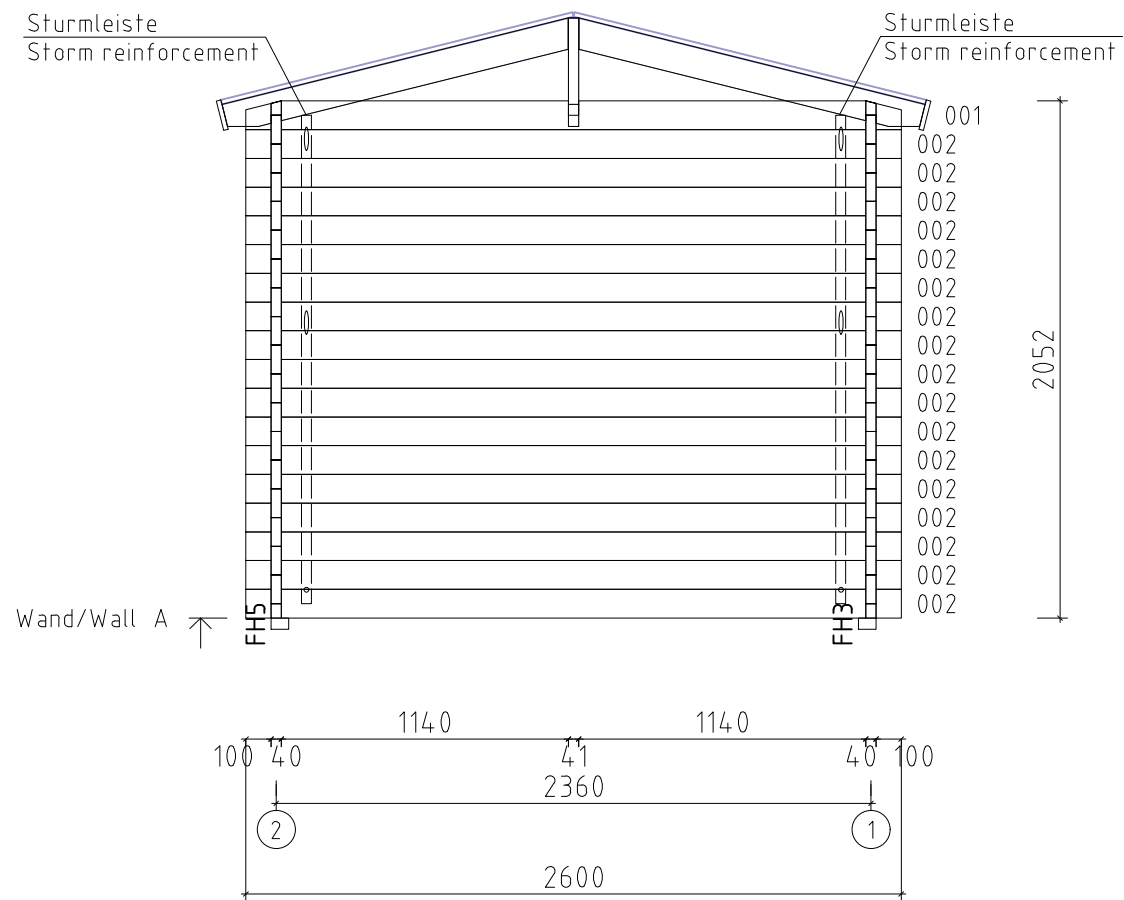

Name	VS40_0174 260x260_40	
Zeichnung/Drawing	WAND/WALL A	
Profil/Profile	4.0x11.4	Datum/Date 28.03.2024

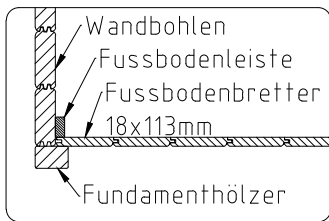
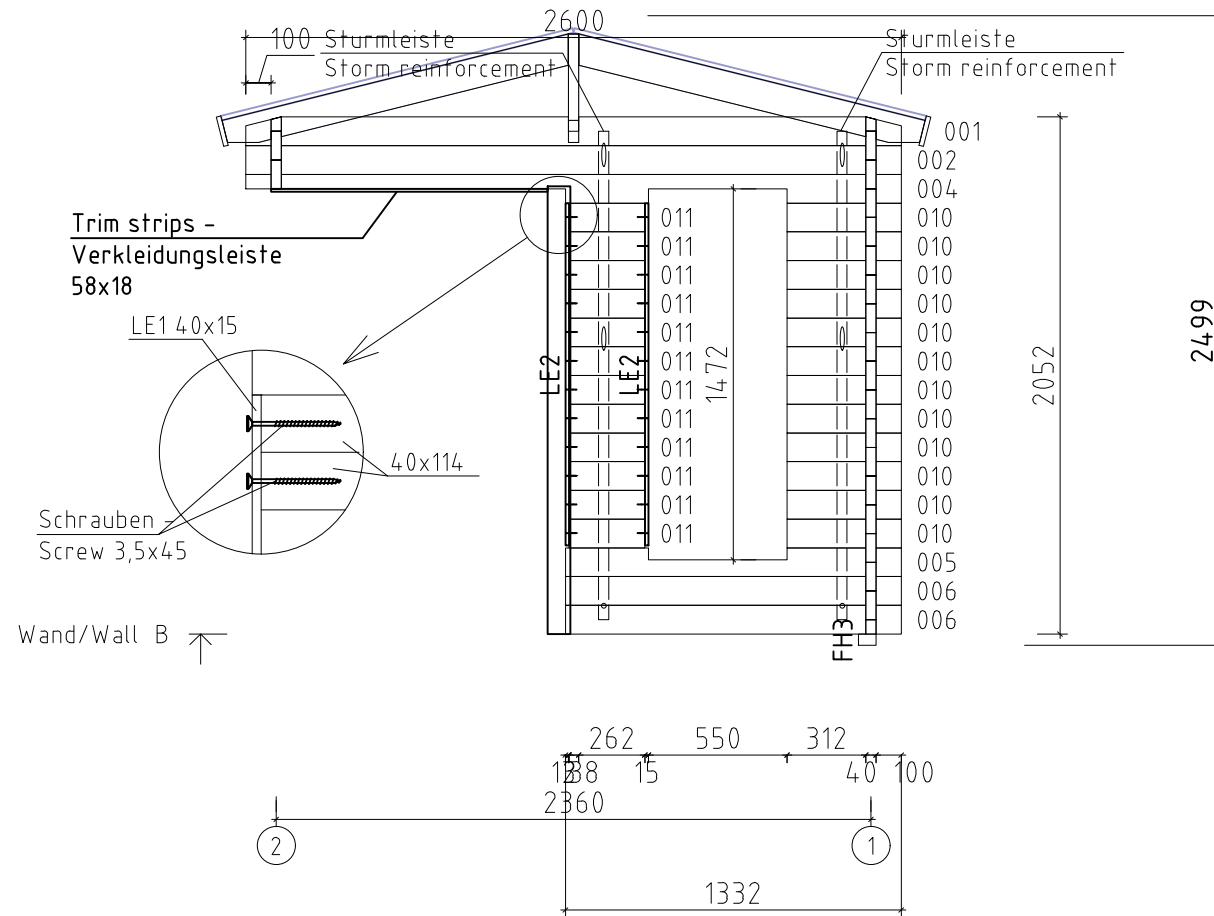

Name	VS40_0174 260x260_40		
Zeichnung/Drawing	WAND/WALL B		
Profil/Profile	4.0x11.4	Datum/Date	28.03.2024

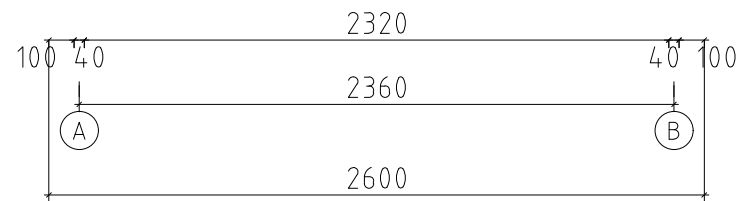
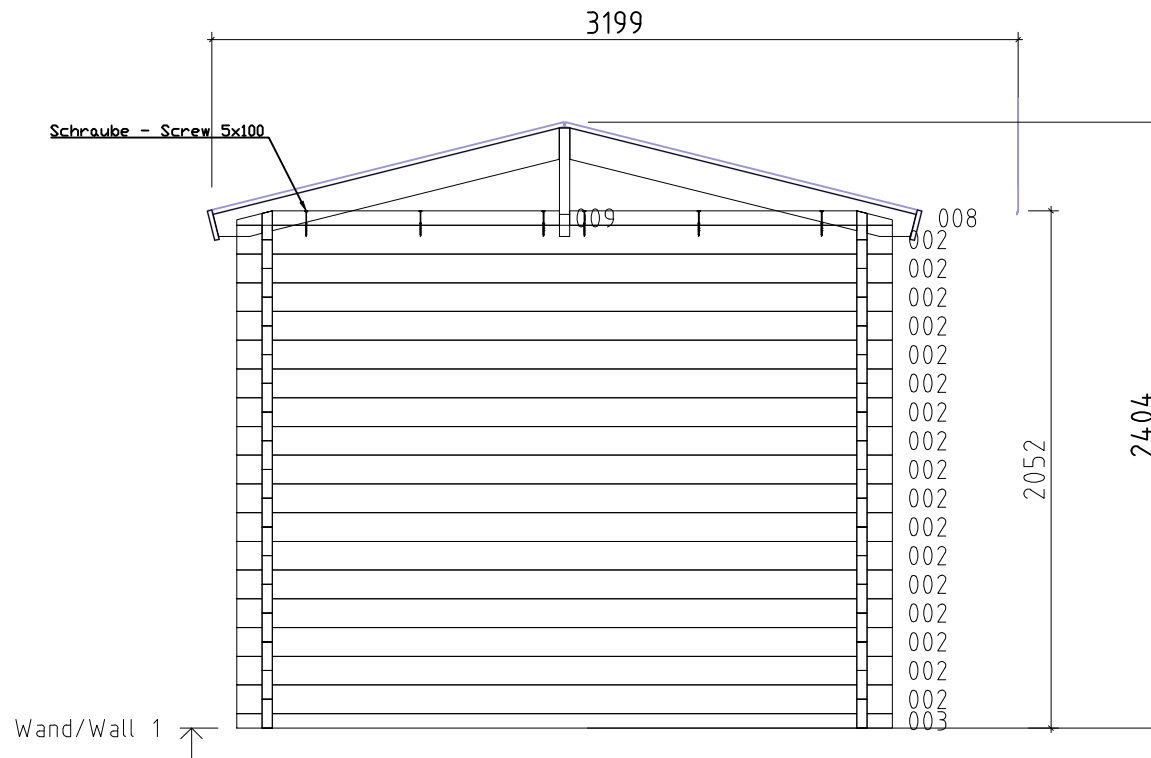

Name	VS40__0174 260x260__40	
Zeichnung/Drawing	WAND/WALL 1	
Profil/Profile	4.0x11.4	Datum/Date 28.03.2024

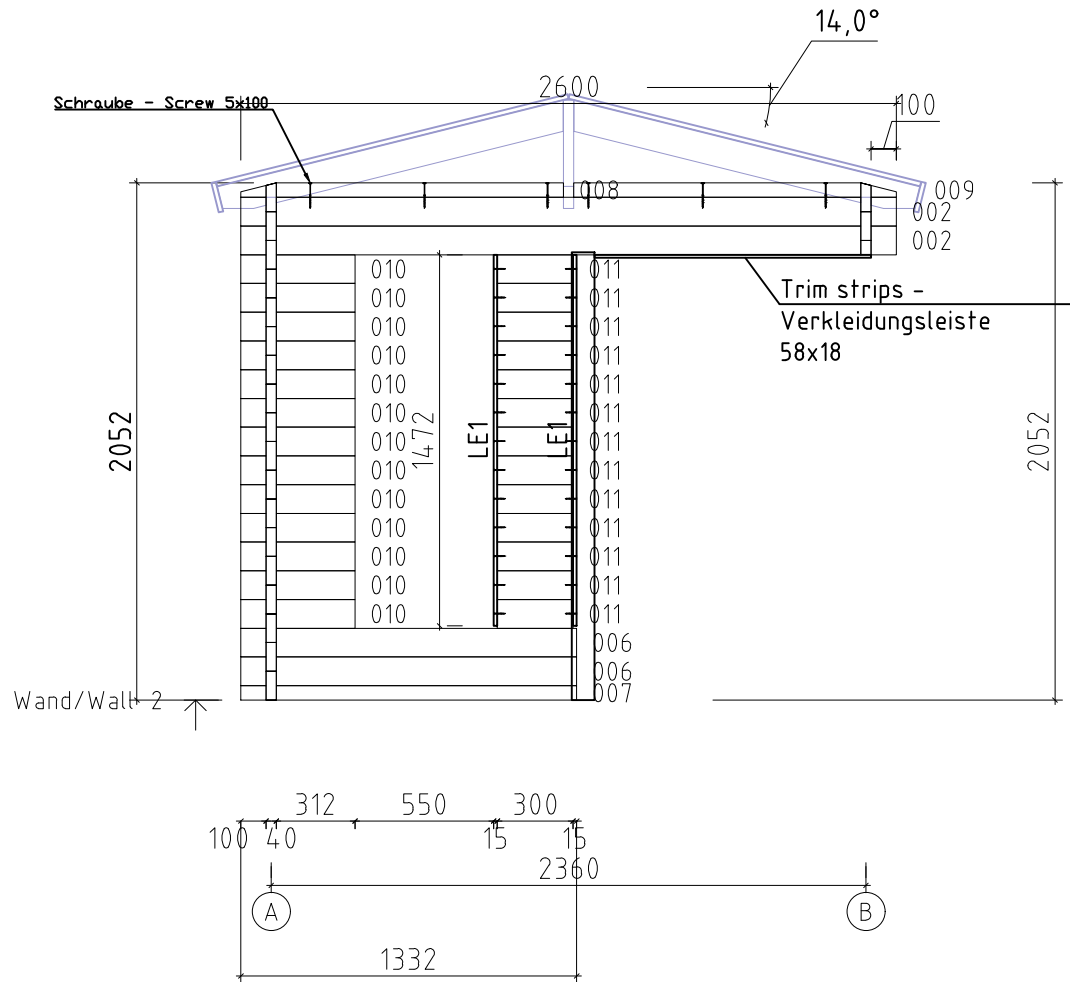

Name	VS40_0174 260x260_40		
Zeichnung/Drawing	WAND/WALL 2		
Profil/Profile	4.0x11.4	Datum/Date	28.03.2024