

Milford / 40 i.P.

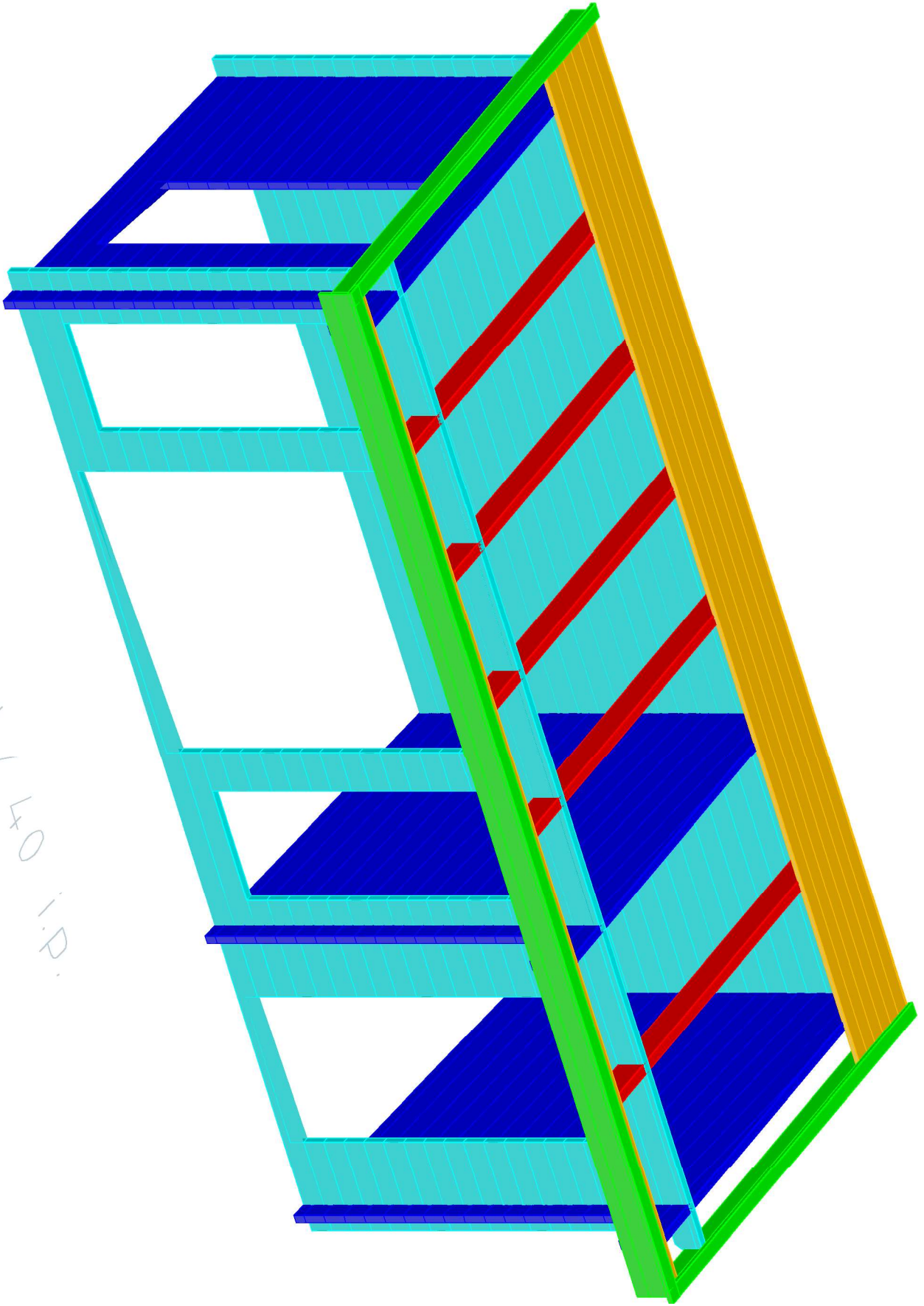

Milford/40

5080

5000

3460

1500

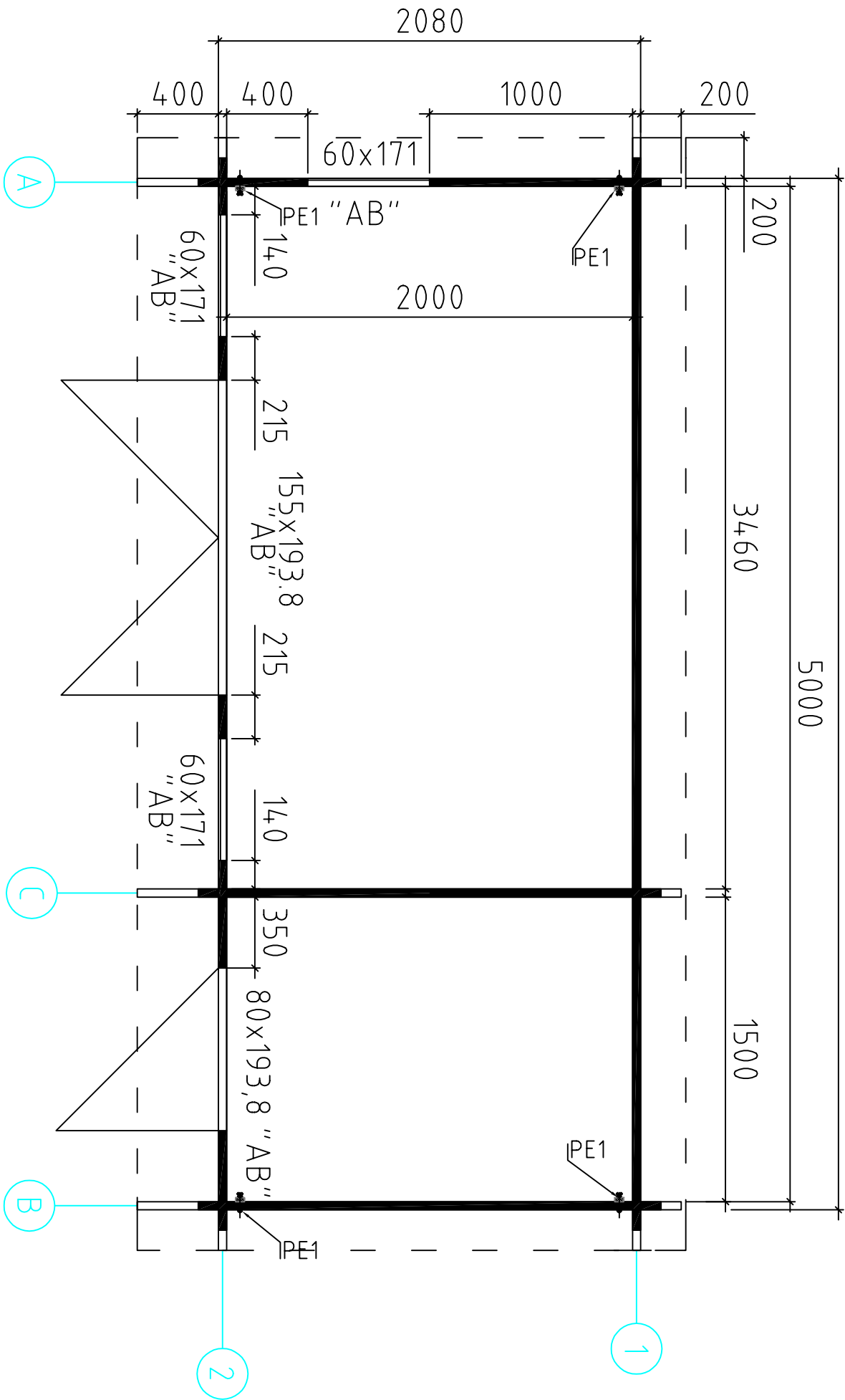

Grundplan

Milford/40

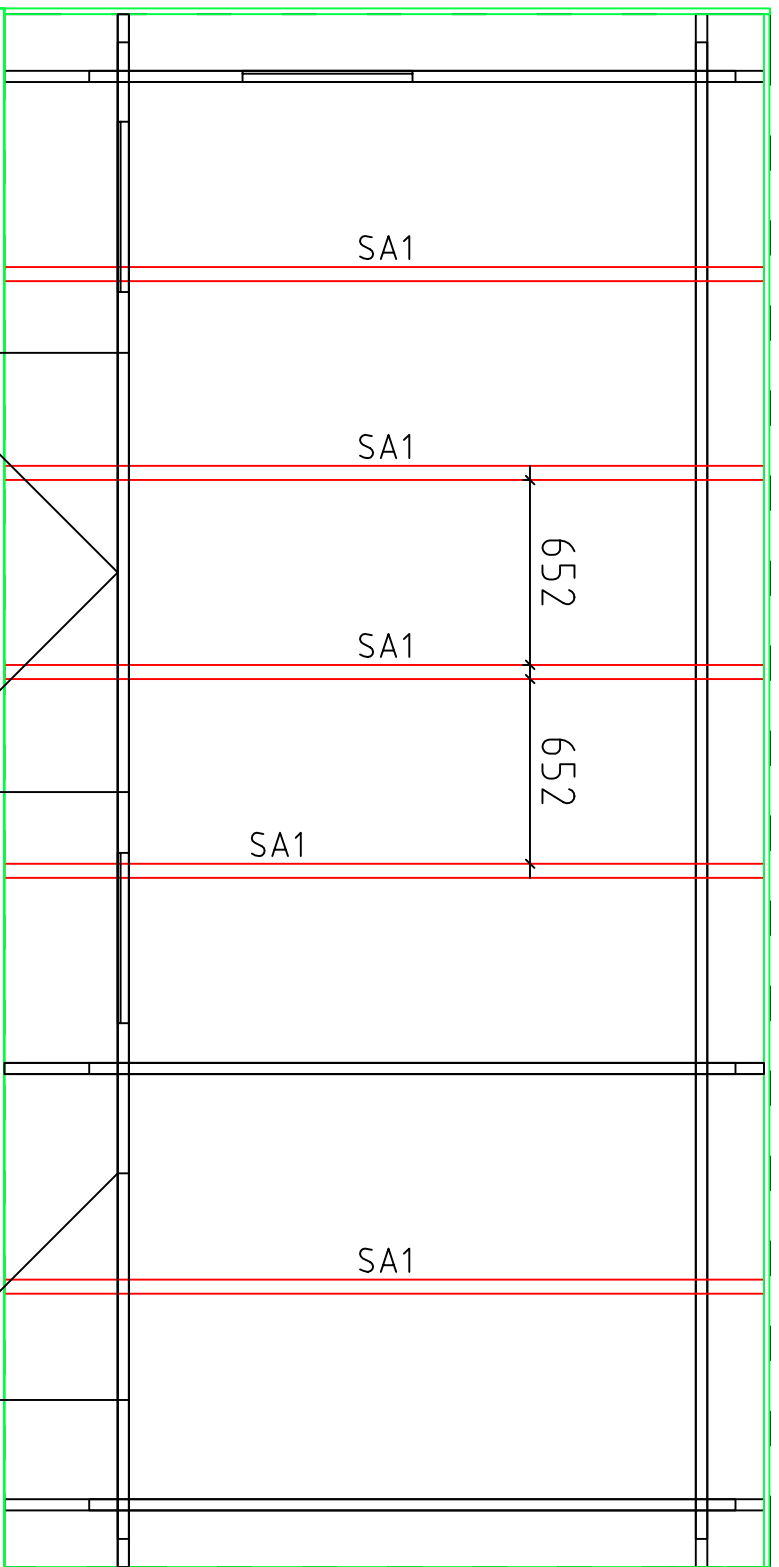

Dachsparren 50x140 (SA)

Milford/40

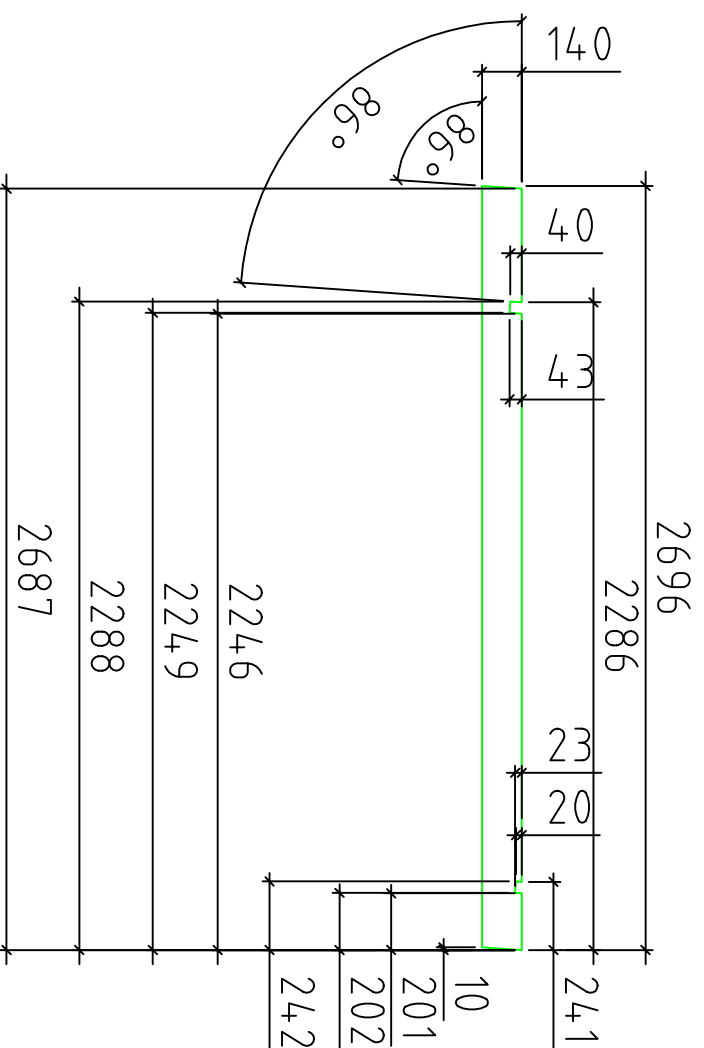

Dachsparren 50x140 (SA1)

Wand 2 ↗

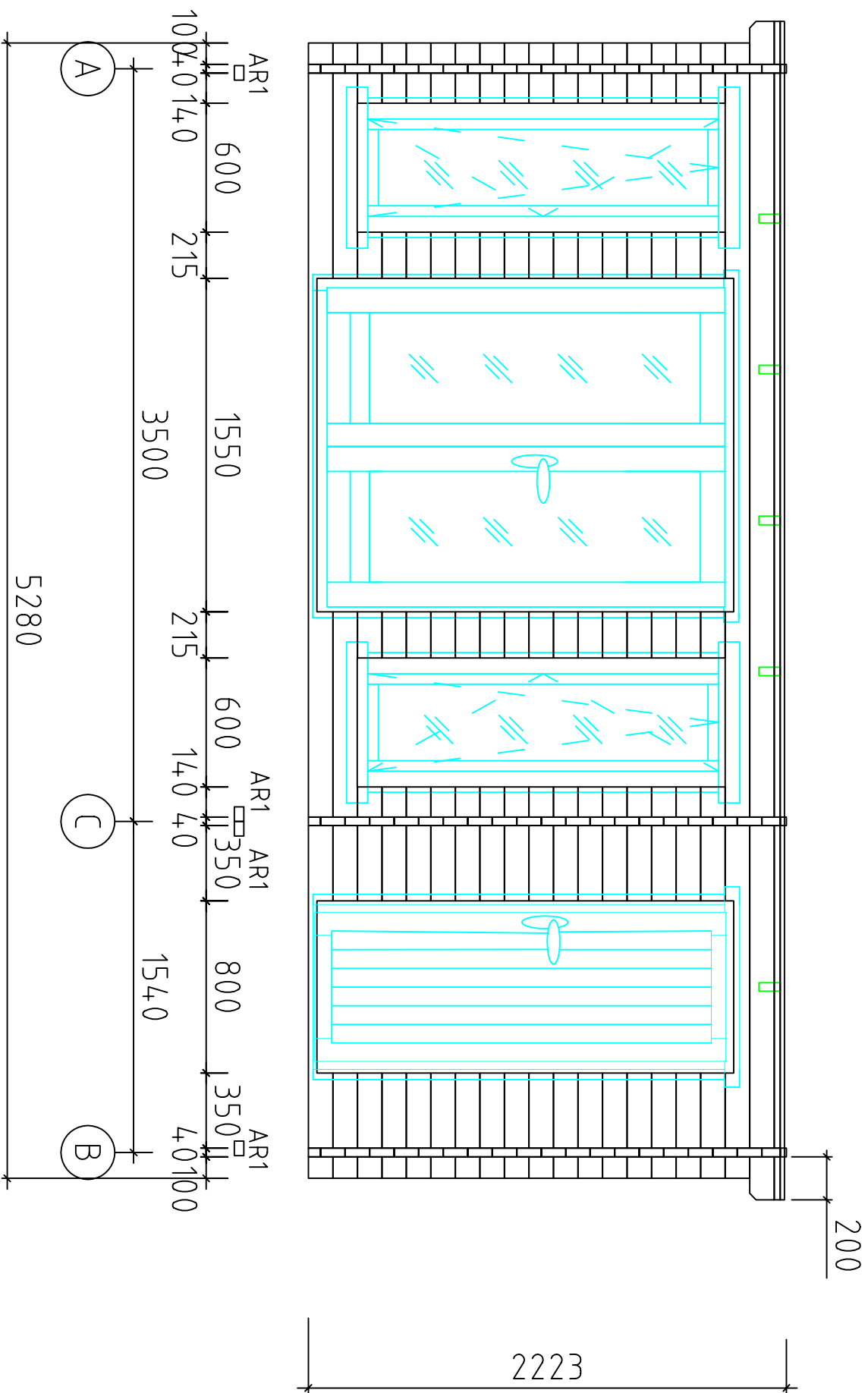

Milford/40

Wand 2 ↗

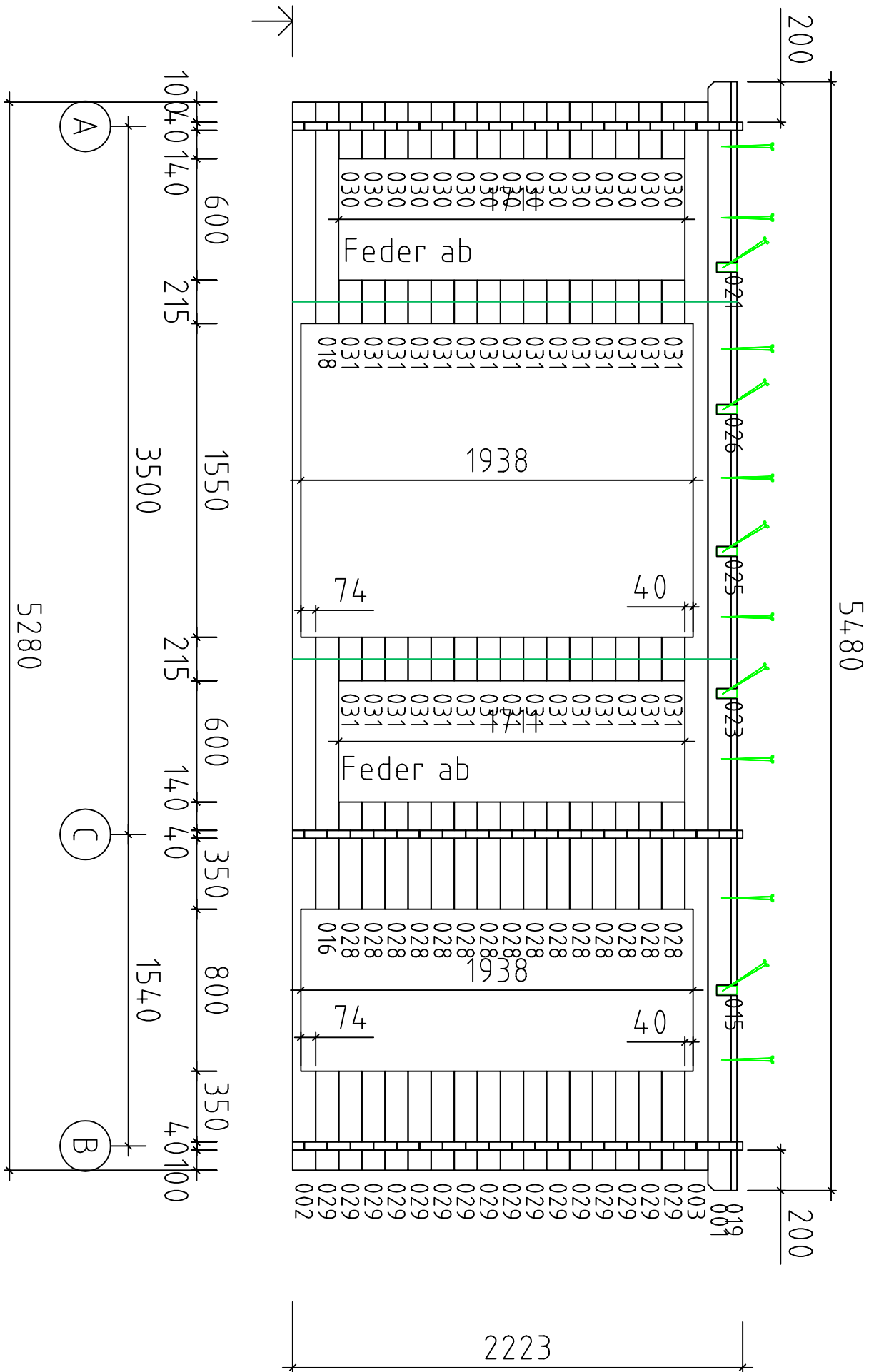

Milford/40

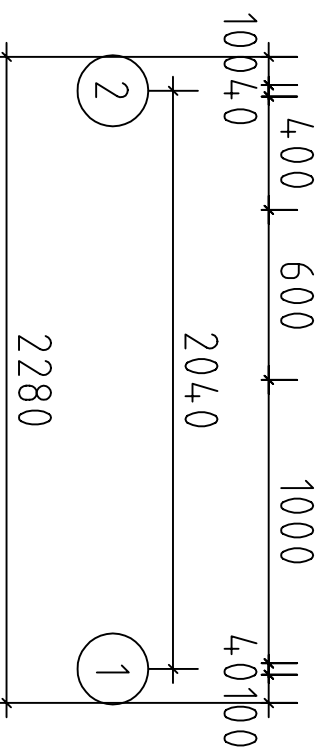
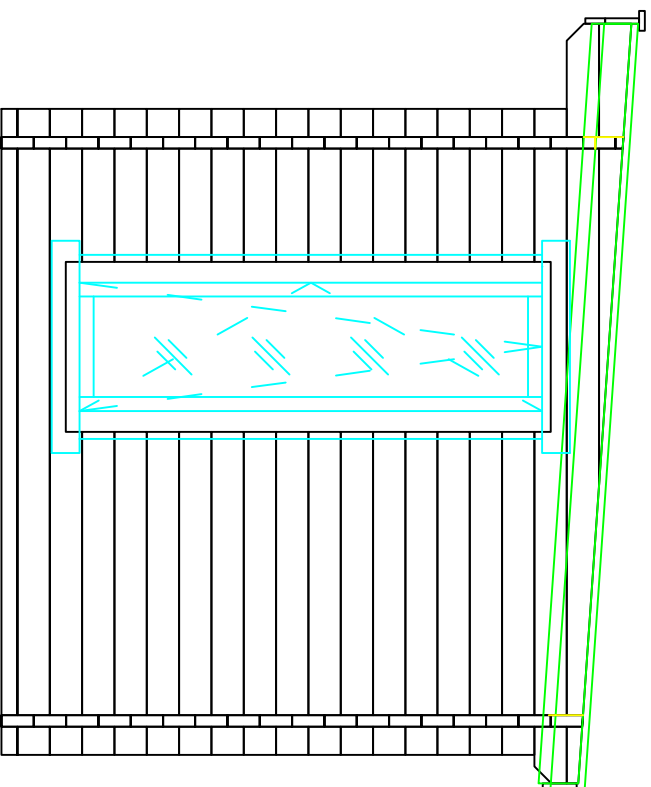



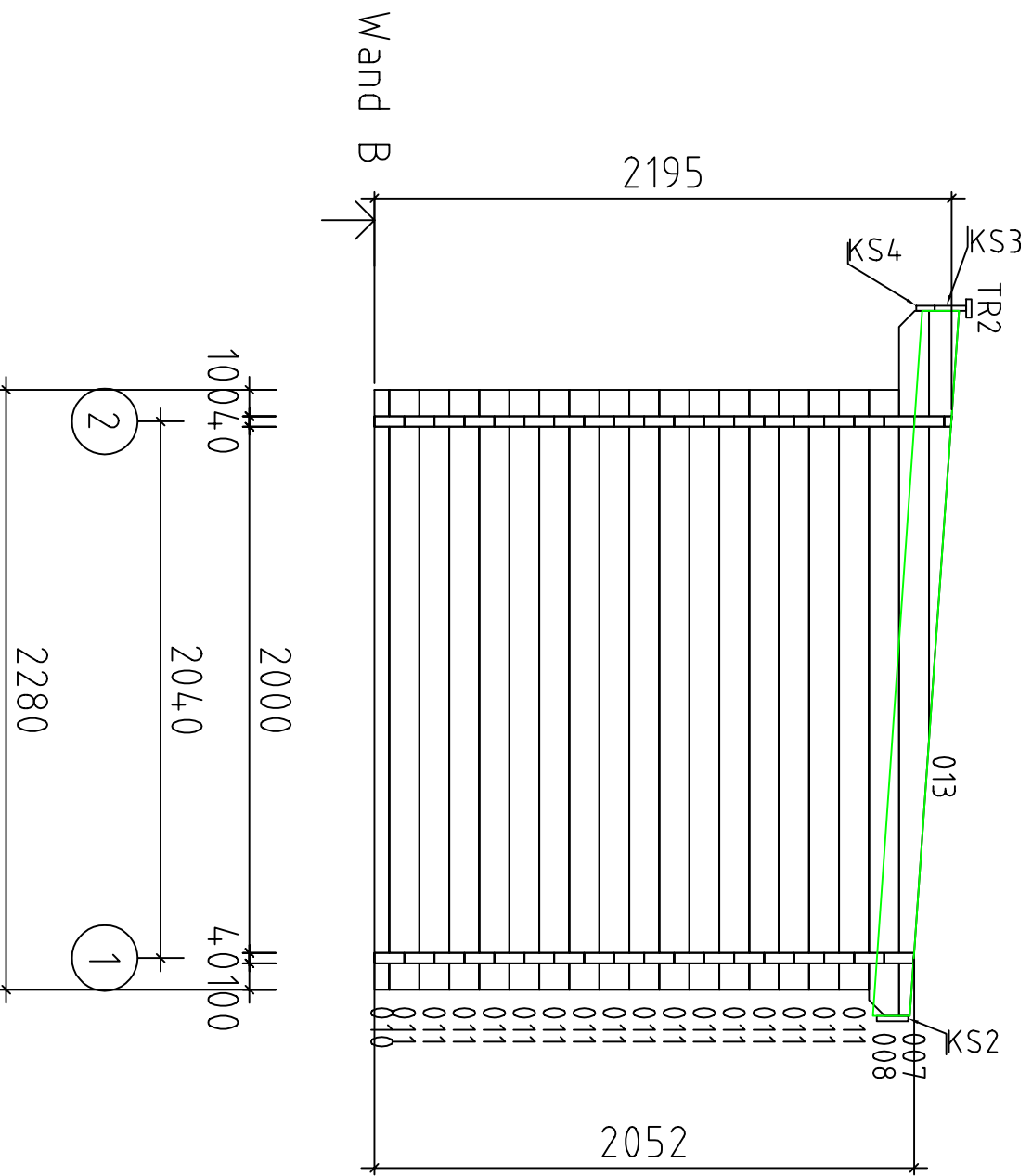



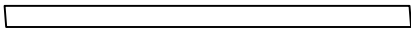

Milford/40

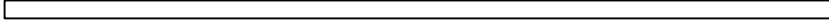

Milford/40

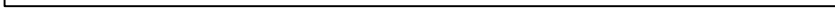
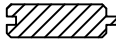
Pos	Milford/40	ST	F (mm)	L (mm)
001		1	40x114	5480
002		1	40x114	5280
003		1	40x114	5280
004		14	40x114	5280
005		2	40x114	5280
006		1	40x114	5280
007		3	40x114	2680
008		2	40x114	2380
009		1	40x114	2380
010		3	40x57	2280
011		33	40x114	2280
012		1	40x114	2280
013		3	40x114	1627
014		1	40x114	1417
015		1	40x29	1417
016		1	40x114	1345
017		14	40x114	1140
018		1	40x114	1095
019		1	40x29	965
020		1	40x114	965
021		1	40x29	892
022		1	40x114	892
023		1	40x29	652
024		3	40x114	652
025		1	40x29	652

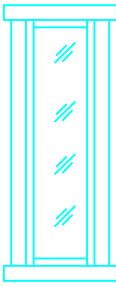
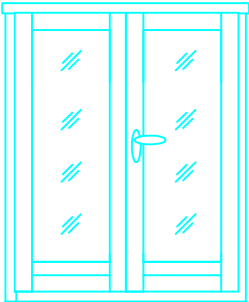
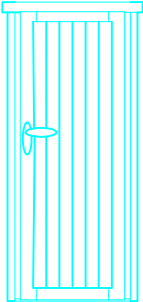
Pos	Milford/40	ST	F (mm)	L (mm)
SA1	Sparren 	5	50.1x140	2696
TR2	Traufenbrett 	1	70x20	5569
TR1	Traufenbrett 	2	70x20	2771
KS3	Karniesen 	1	20x120	5520
KS2	Karniesen 	1	20x120	5480
KS1	Karniesen 	2	20x120	2717
KS4	Karniesen 	1	20x70	5520
0206-1	Dachbretter 	31	90x20	5480
	Abdeckleiste 		20x40	20m
	Fenster 600x1710 DK "AB" 	1L+2R		
	Tür 1550x1938 "AB" 	1		
	Tür 800x1938 "AB" !!! 	1R		
	Dübel	20	11,2x11,2	390

Montagekit

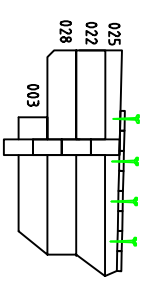
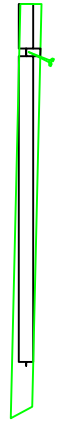
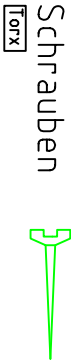
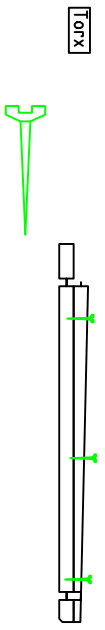

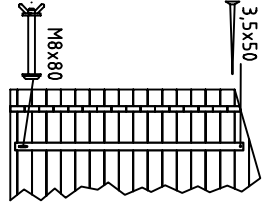

Pos	Milford/40	ST	F (mm)	L (mm)
	 <p>Schrauben Torx</p>	40	5x130	
	 <p>Schrauben Torx</p>	300	4x45	
	 <p>Schrauben Torx</p>	60	4x45	
	 <p>Schrauben Torx</p>	18	5x130	

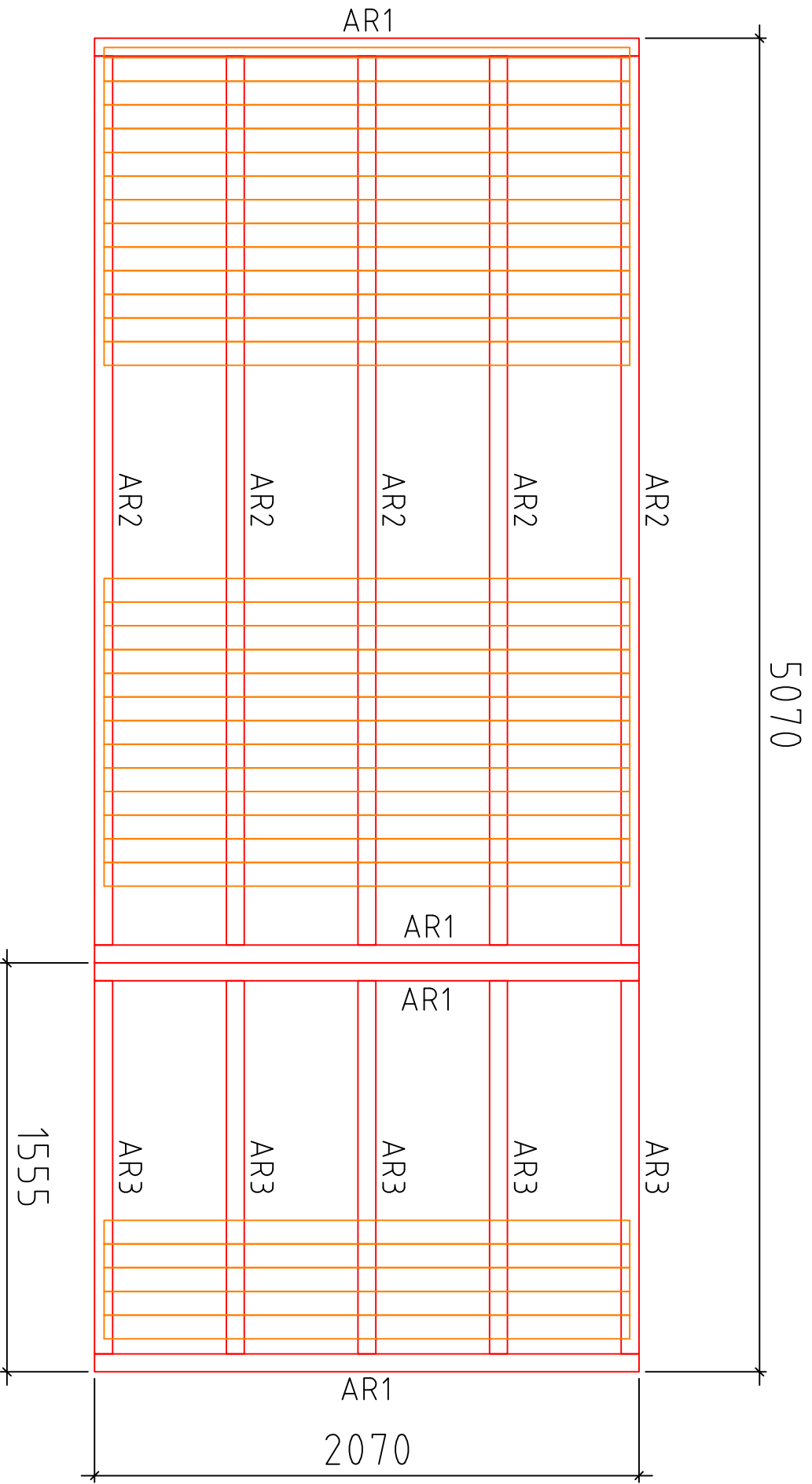
Pos	ST	F (mm)	L (mm)
Sturmleiste			
 <p>3,5x50 M8x80</p>			
Sturmleisten	2	70x20	2160
Bolzen spez.	4	M8x80	2025
Schrauben 3,5x50	4		

Milford / 40 F / F / F



Milford / 40 F/F/F

Pos		ST	F ^F (mm)	L ^L (mm)
AR2	 <p>Fundamentbalken</p>	5	68x44	3379
AR1	 <p>Fundamentbalken</p>	4	68x44	2070
AR3	 <p>Fundamentbalken</p>	5	68x44	1419
0203-1	<p>Fussbodenbretter</p> 	56	90x20	1998
	<p>Abdeckleiste</p> 		20x40	18m

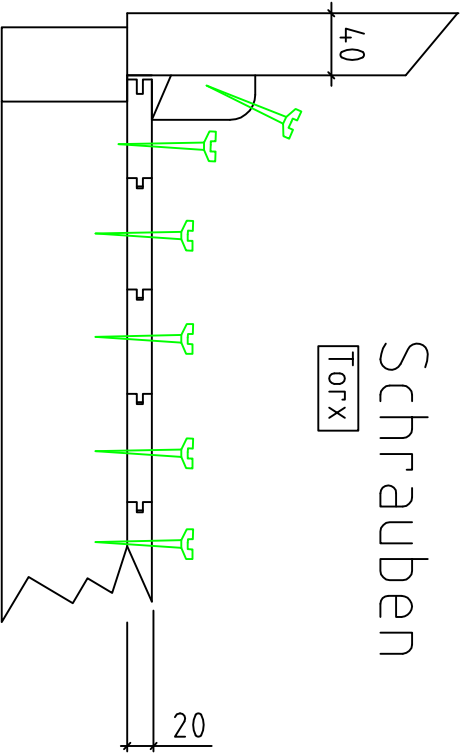
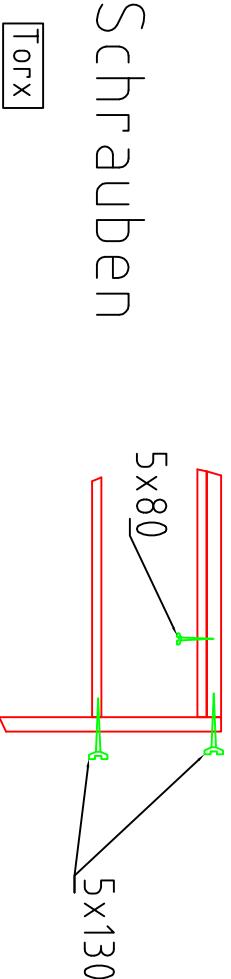
	<h1>Montagekit</h1>				
Abdeckleisten Fussboden	 <p style="text-align: center;">Schrauben Torx</p>	100	3,5x45		
Fundament	 <p style="text-align: center;">Schrauben Torx</p>	40 16	5x130 5x80		