

Camille / 40

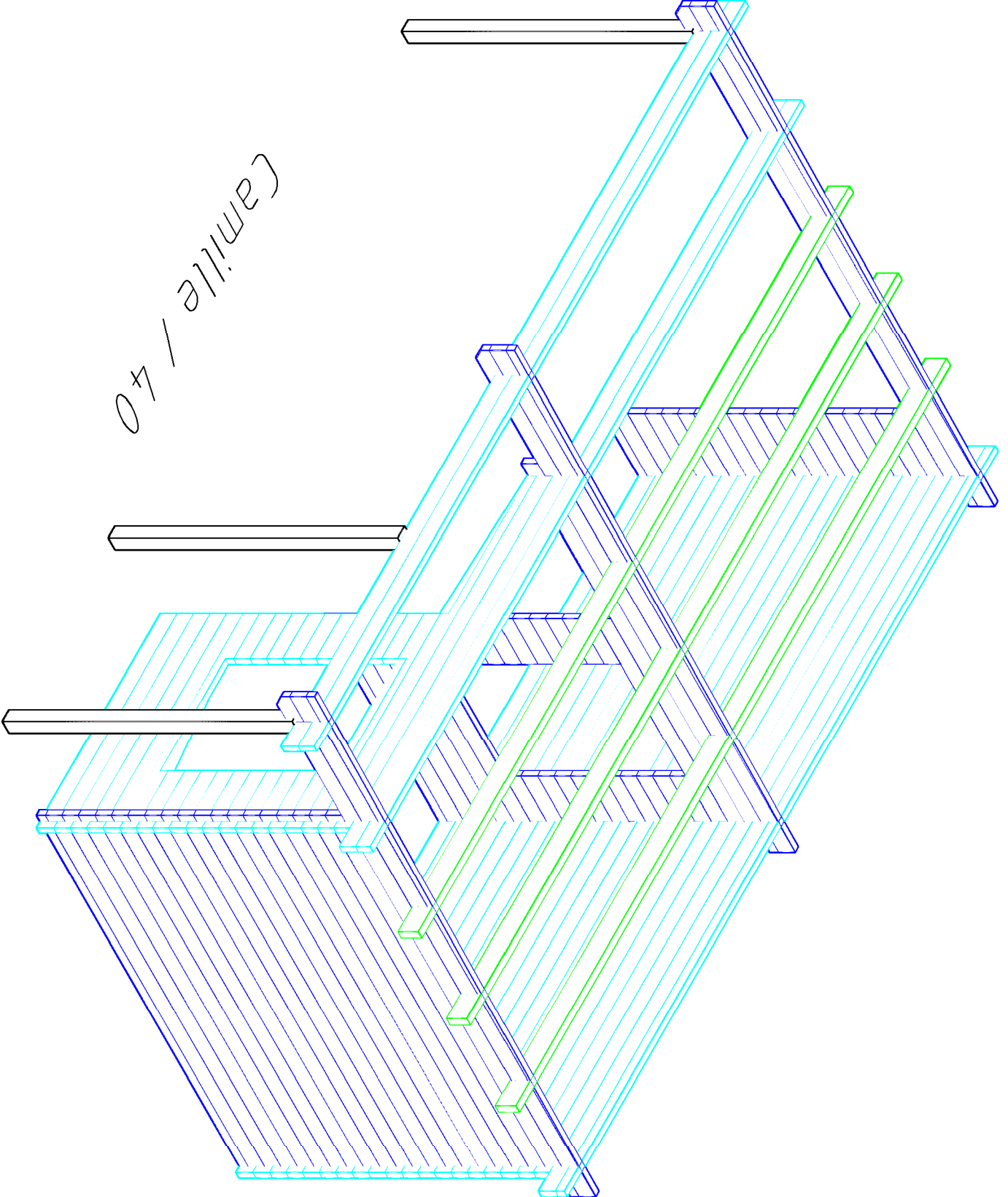

Camille / 40

5560

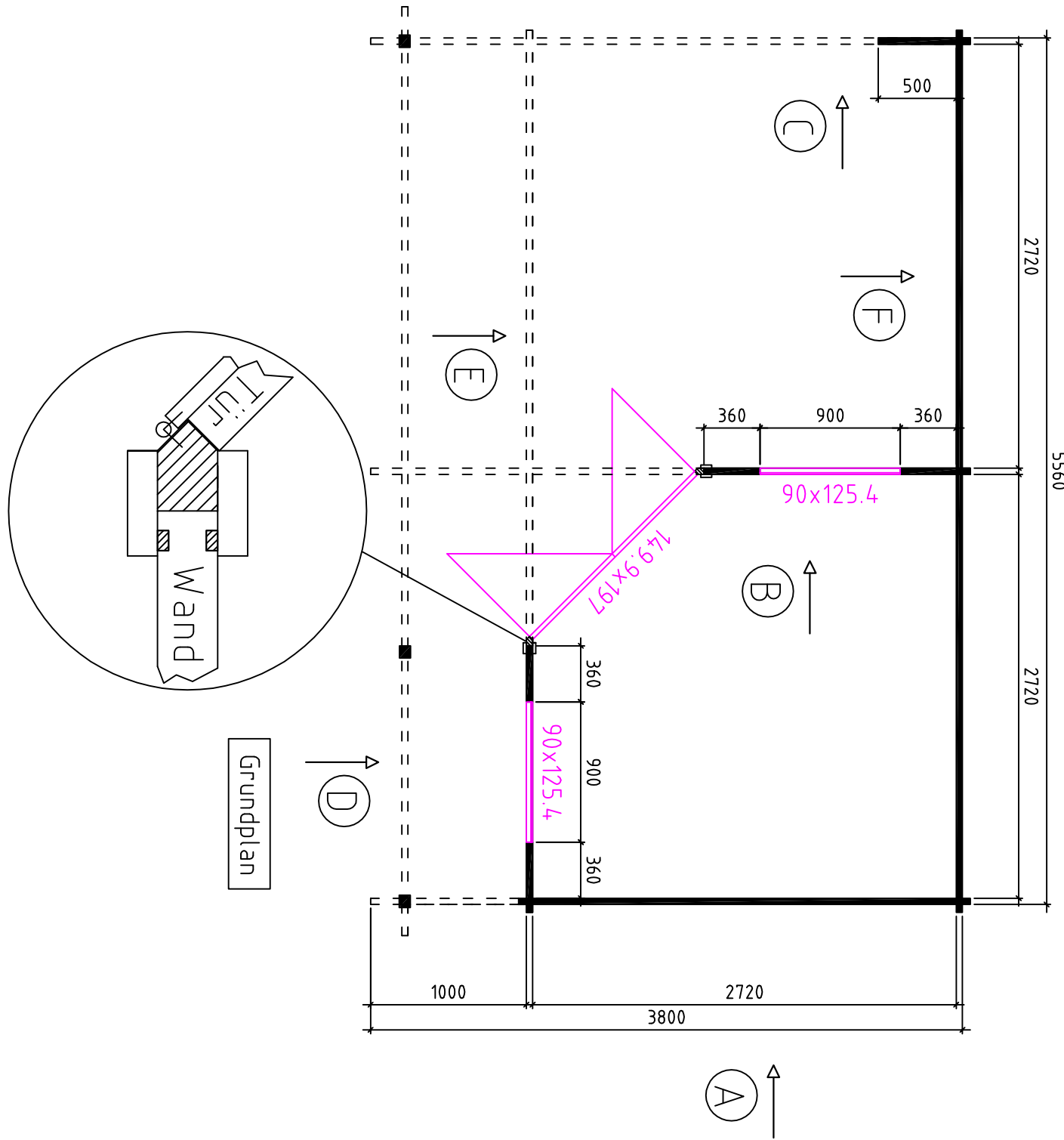

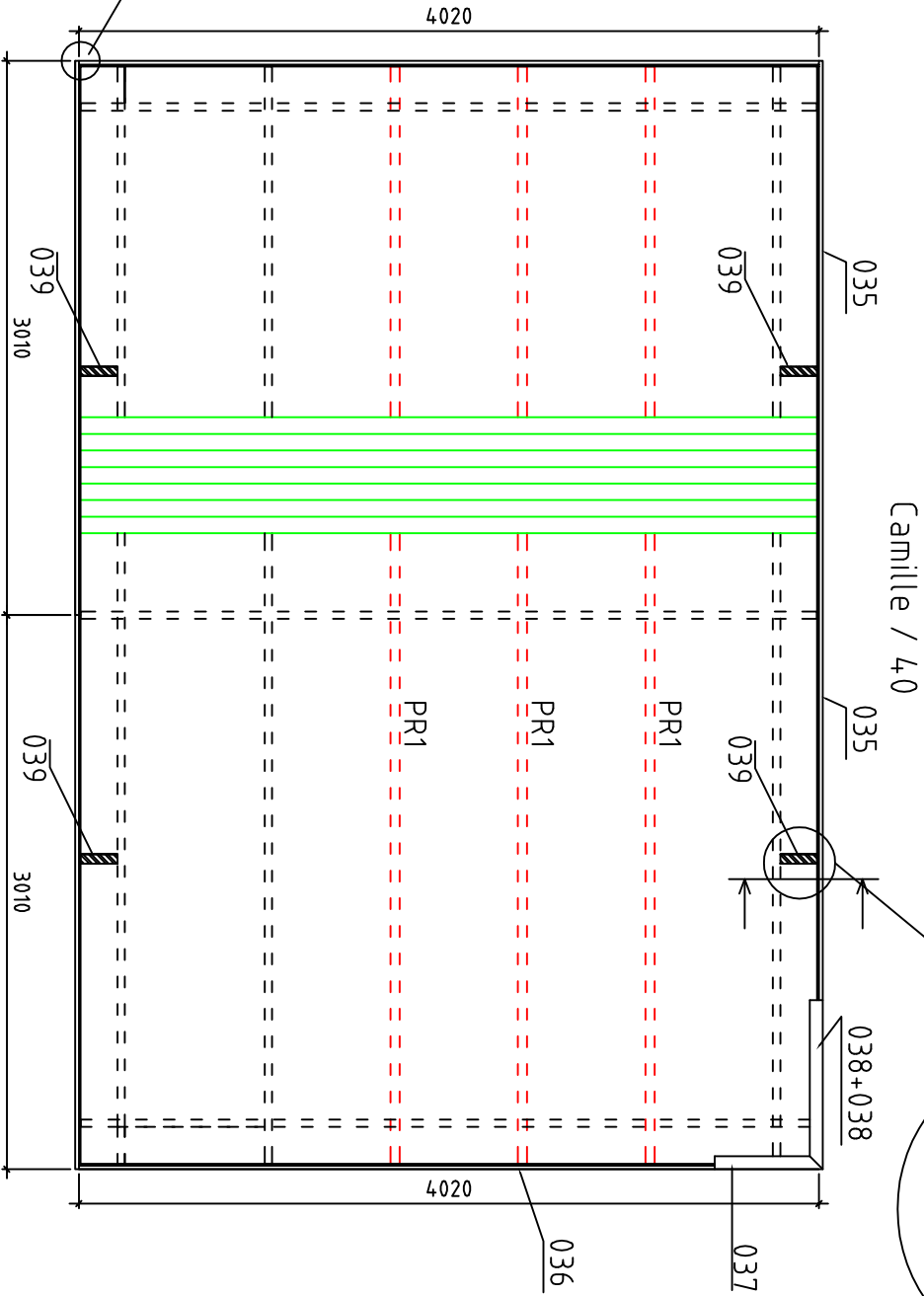
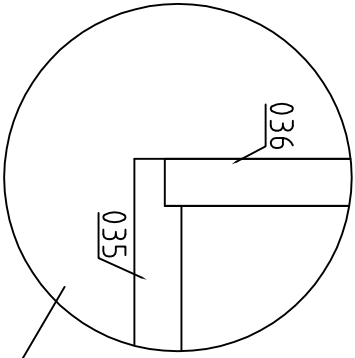



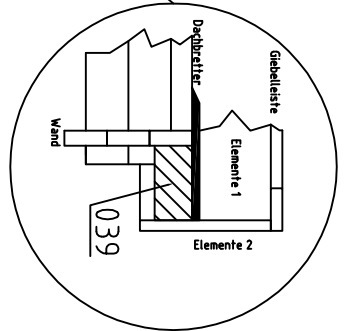

Camille / 40

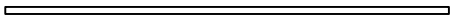
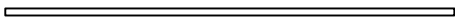
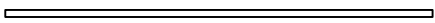

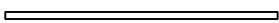
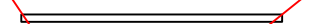
Dachbalken
Dachbretter
Elemente
Giebelleiste
Träger

Pos	Camille / 40	ST	F (mm)	L (mm)
AR7	Fundamentbalken 	1	68x44	467
AR6	Fundamentbalken 	1	68x44	2760
AR1	Fundamentbalken 	1	68x44	2722
AR2	Fundamentbalken 	4	68x44	2654
AR3	Fundamentbalken 	1	68x44	2120
AR4	Fundamentbalken 	2	68x44	1693
AR5	Fundamentbalken 	1	68x44	1548
001	Fussbodenbretter 	31	90x20	2716
003	Abdeckleiste 		20x40	16m

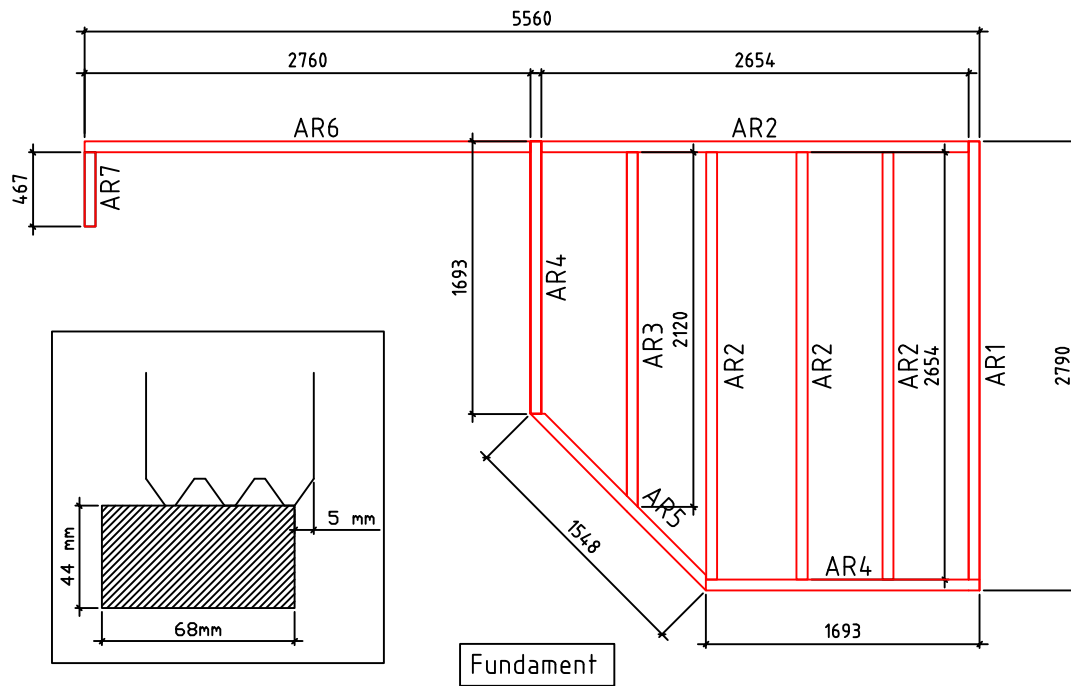

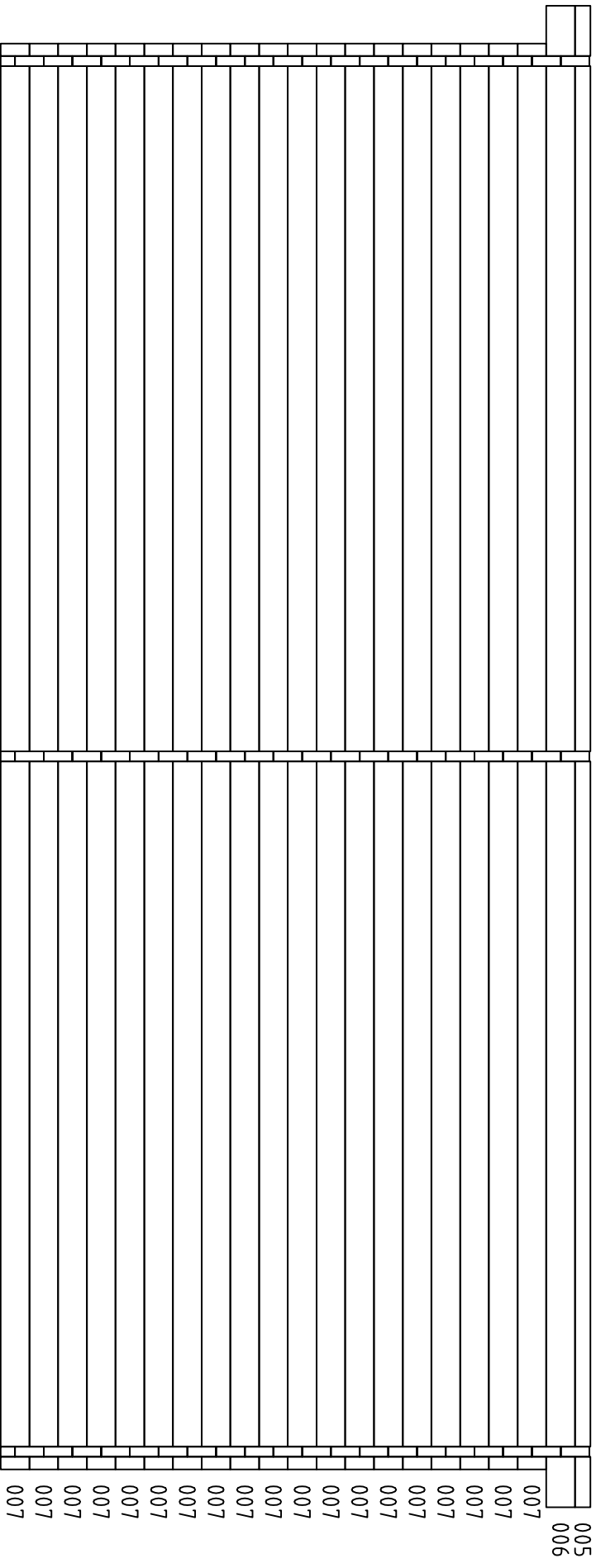

Camille / 40

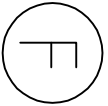

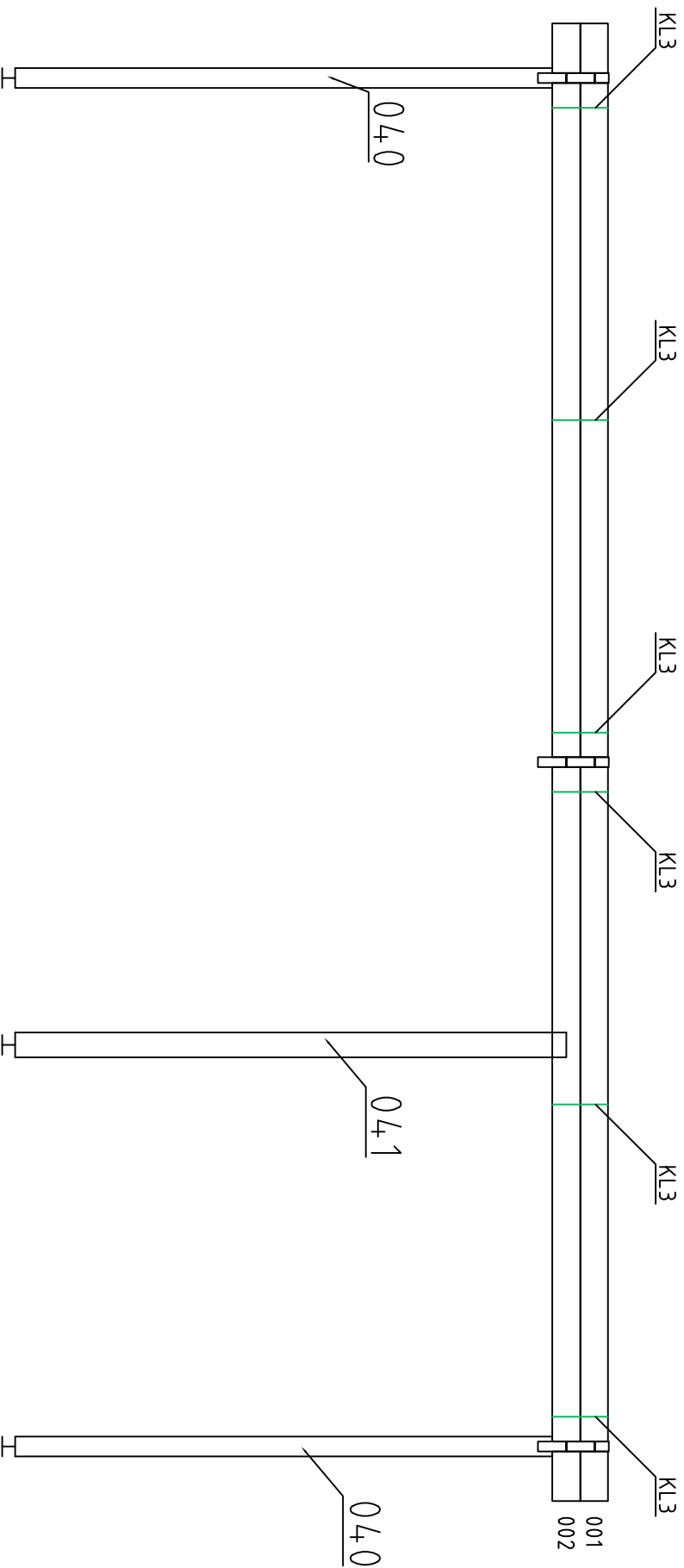

5960

Camille / 40

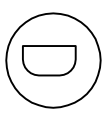

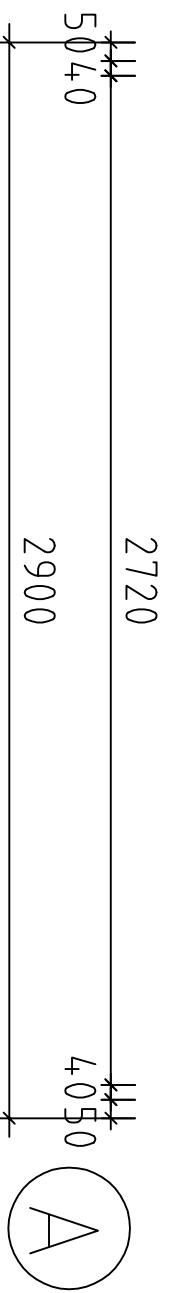
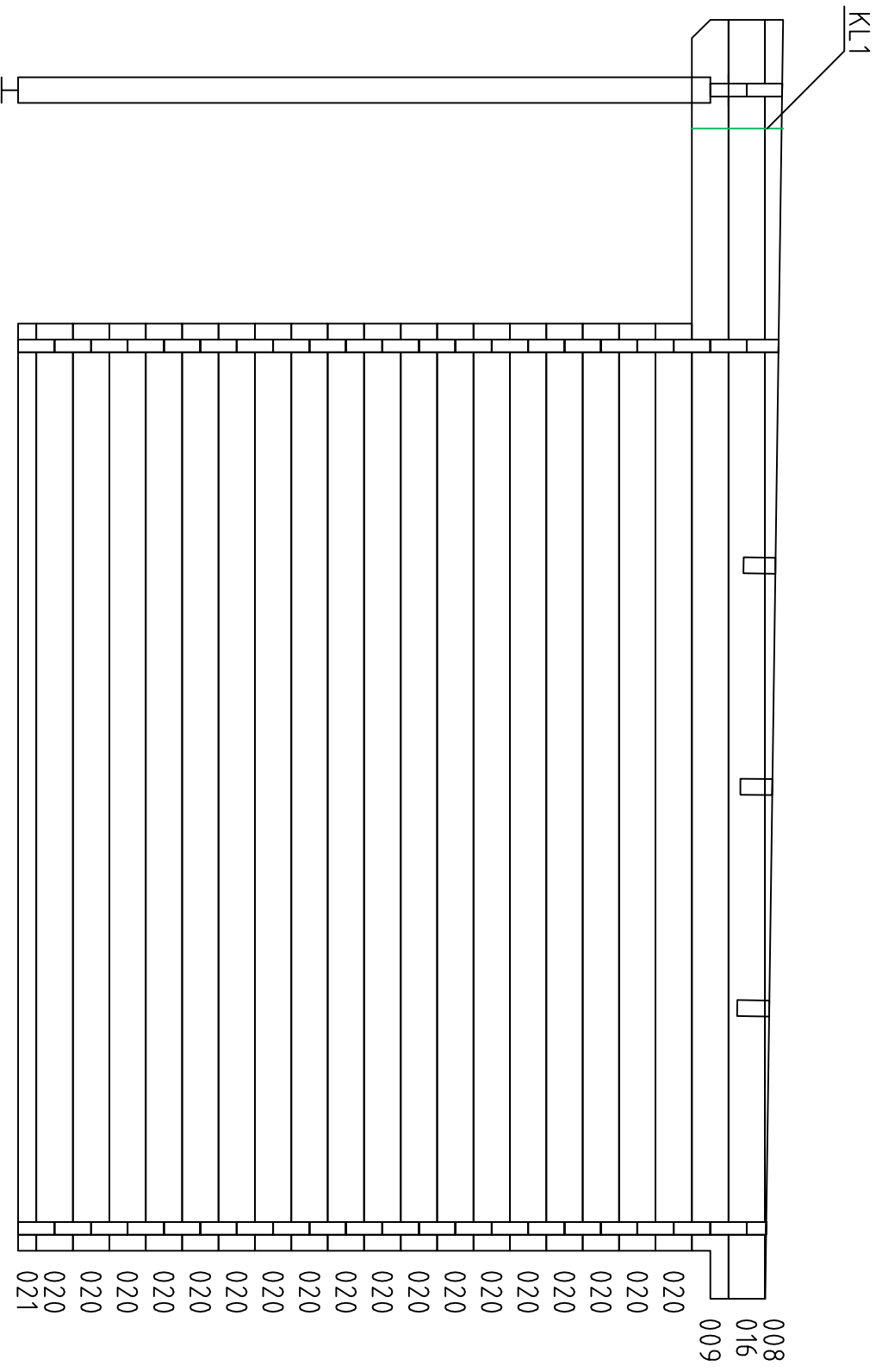

Camille / 40

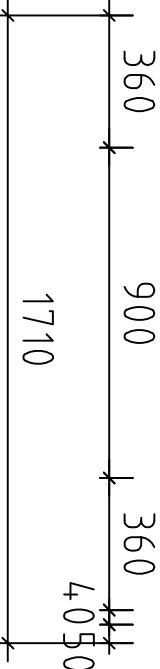
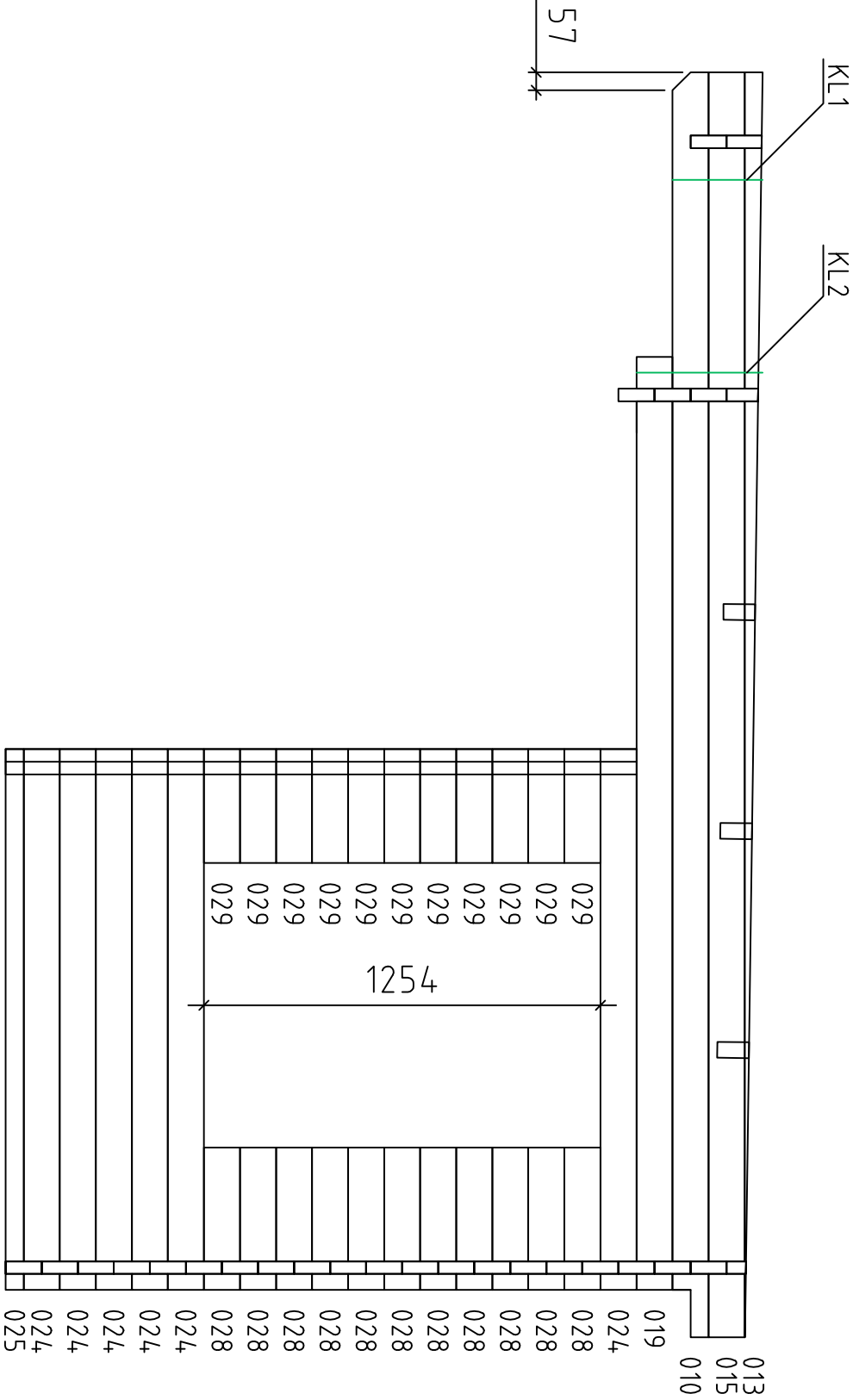

(B)



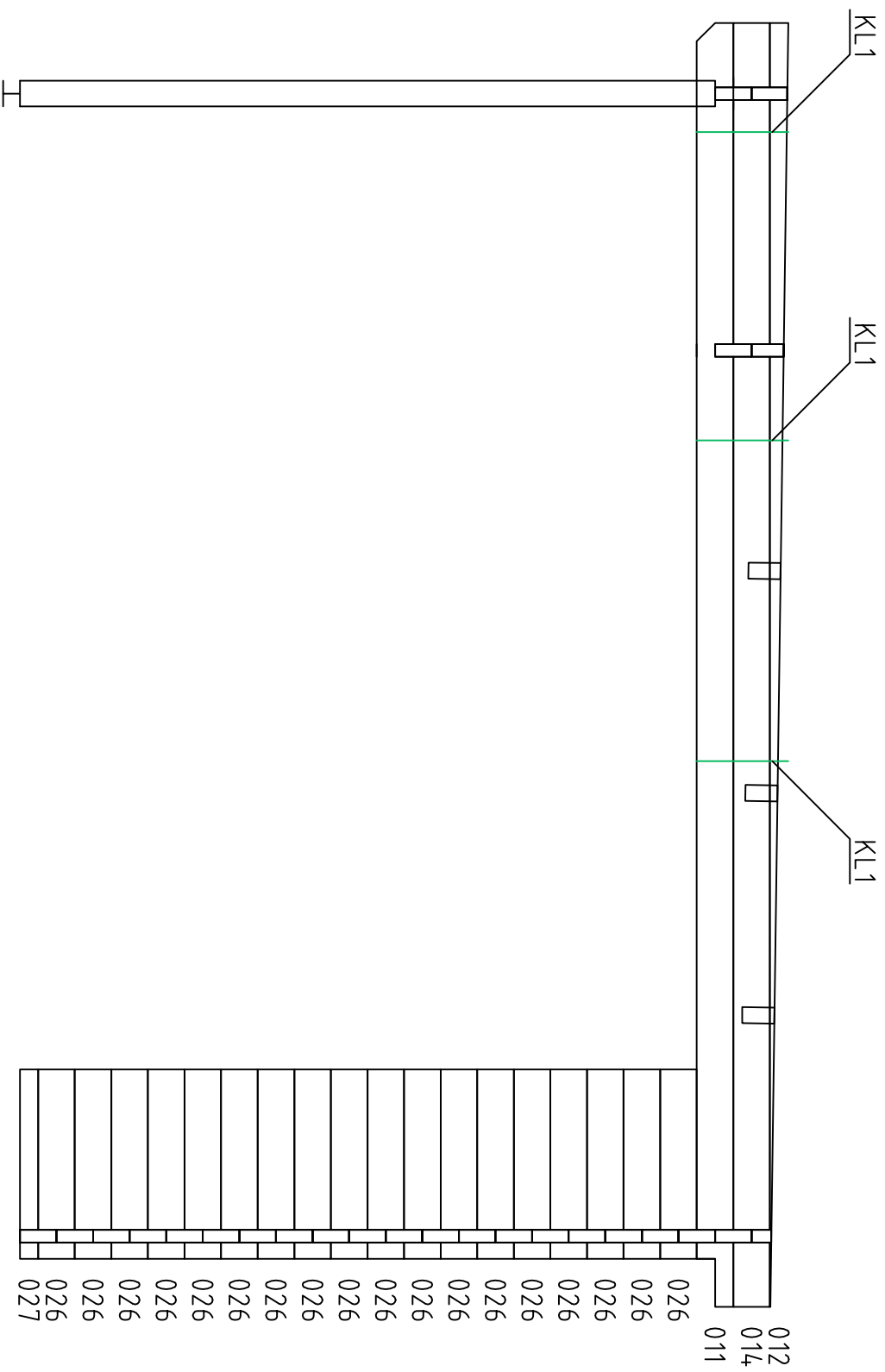



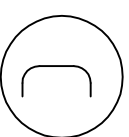
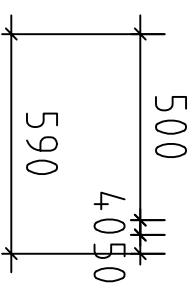

Camille / 40

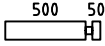
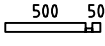

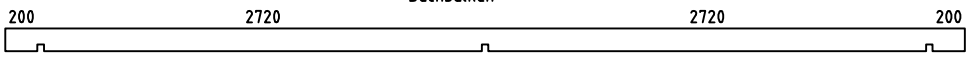
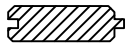
Camille / 40

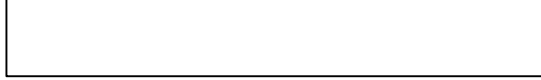
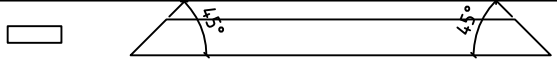
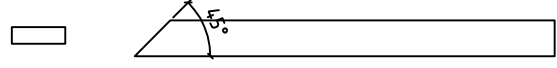

Pos	Camille / 40	ST	F (mm)	L (mm)
001		1	40x111	5960
002		1	40x114	5960
003		1	40x100	5960
004		1	40x114	5960
005		1	40x61	5960
006		1	40x114	5960
007		19	40x114	5660
008		1	40x57	4000
009		1	40x114	4000
010		1	40x114	4000
011		1	40x114	4000
012		1	40x57	4000
013		1	40x57	4000
014		1	40x114	4000
015		1	40x114	4000
016		1	40x114	4000
017		1	40x114	2950
018		1	40x114	2950
019		1	40x114	2950
020		18	40x114	2900
021		1	40x57	2900
022		1	40x114	1710
023		1	40x114	1710
024		11	40x114	1710
025		1	40x57	1710

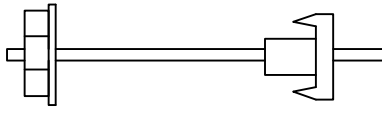
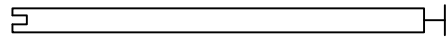
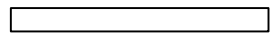
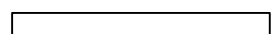
Pos	Camille / 40	ST	F (mm)	L (mm)
026		18	40x114	590
027		1	40x57	590
028		21	40x114	450
029		21	40x114	360
PR1		3	50x140	5960
030	Dachbretter Dakplanken Roofboarc's 	68	90x20	4000
031	Abdeckleiste Afdeklijst Finishinglist 		20x40	25m
032	Fenster 900x1254 Raam Window  ISO 727x1062	2		
033	Doppel Tür Double door Dubbele deur 1499x1970  ISO 551x1062 2tk Roostevaba plekk 1498x28x34	1		
034	Giebelelement Frontelement Gevelement 	1	1060x1060	
035	Element 	2+2	270x28	3010
036		2	270x28	4020
037	Giebelleiste Gevelanderlijst Frontlist 	2	70x20	4060
038	Giebelleiste Gevelanderlijst Frontlist 	4	70x20	3010
039	Träger 	4	50x140	200
KL1	Polzen für Wand 	5	M12	310
KL2		1	M12	420
KL3		6	M12	250
KL4		2	M12	230
KL5		1	M12	460
040	Pfosten 	2	90x90	2166
041		1	90x90	2223
100	Abdeckleiste List Lijsten 	1	20x50	1580
101	Abdeckleiste List Lijsten 	1	20x90	1499

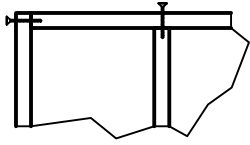
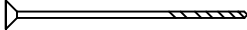
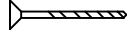
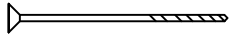
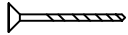
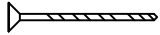
Pos	Camille / 40	ST	F (mm)	L (mm)			
Fundament		Torx	Schrauben 6x130		20		
Fussboden Dach		Torx	Schrauben 3,5x50		900		
Montagematerial	Giebel Giebelbretter Elemente Pfosten u.s.w.	Torx	Schrauben 6x130		100		
		Torx	Schrauben 3,5x50		200		
		Torx	Schrauben 5,0x80		400		

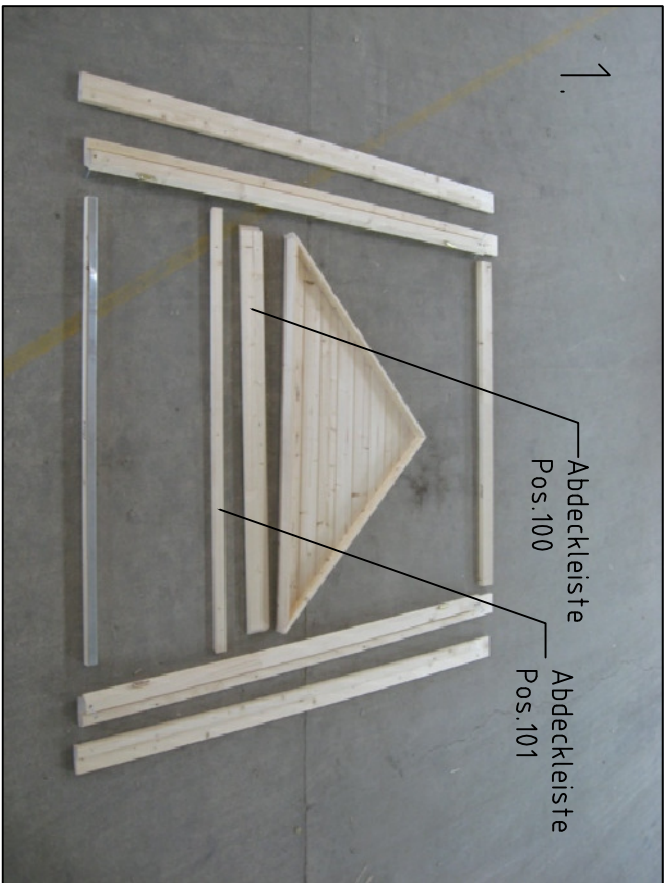



1.



3.

Abdeckleiste
Pos.101



2.

Abdeckleiste
Pos.100



4.