

*Liverpool 1*  
*Art. Nr.7016344*

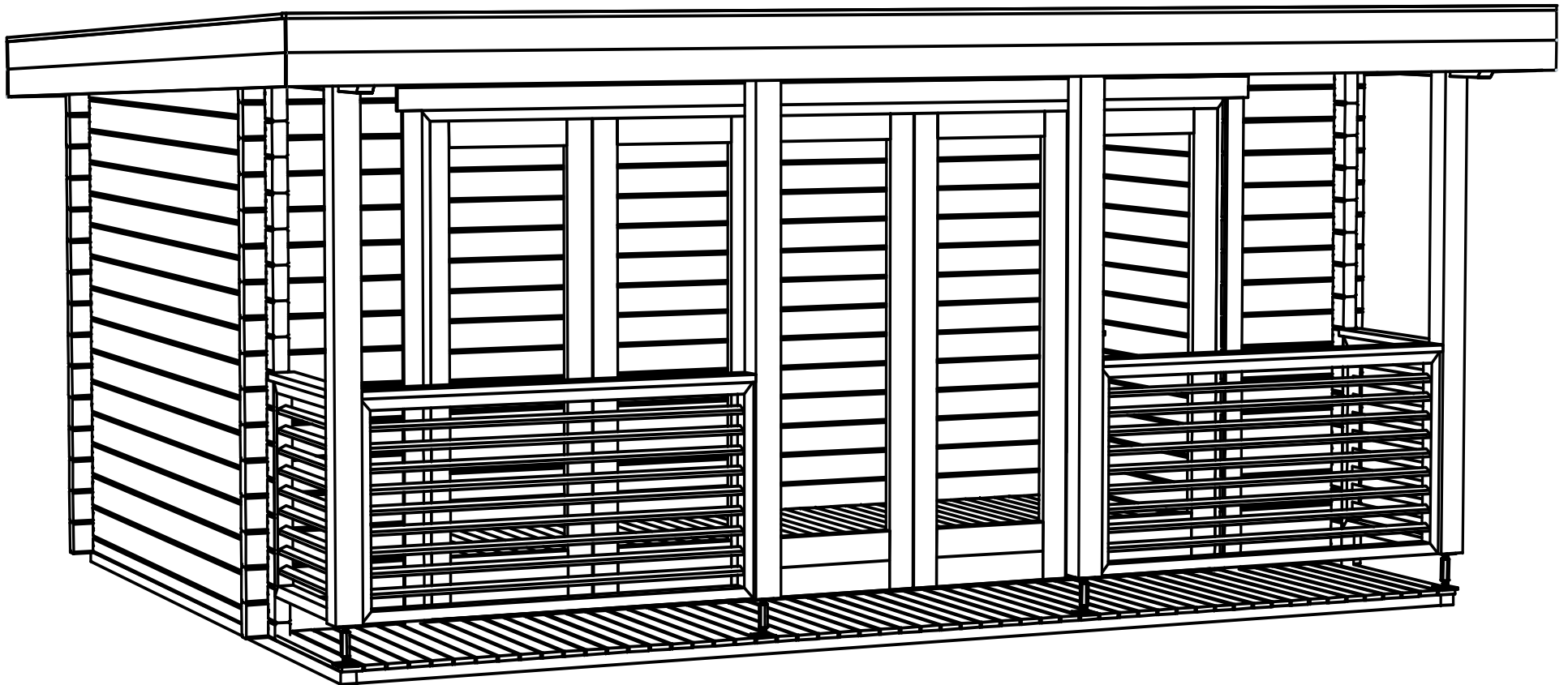

GROUNDPLAN - GRUNDPLAN - PLAN DE MASSE

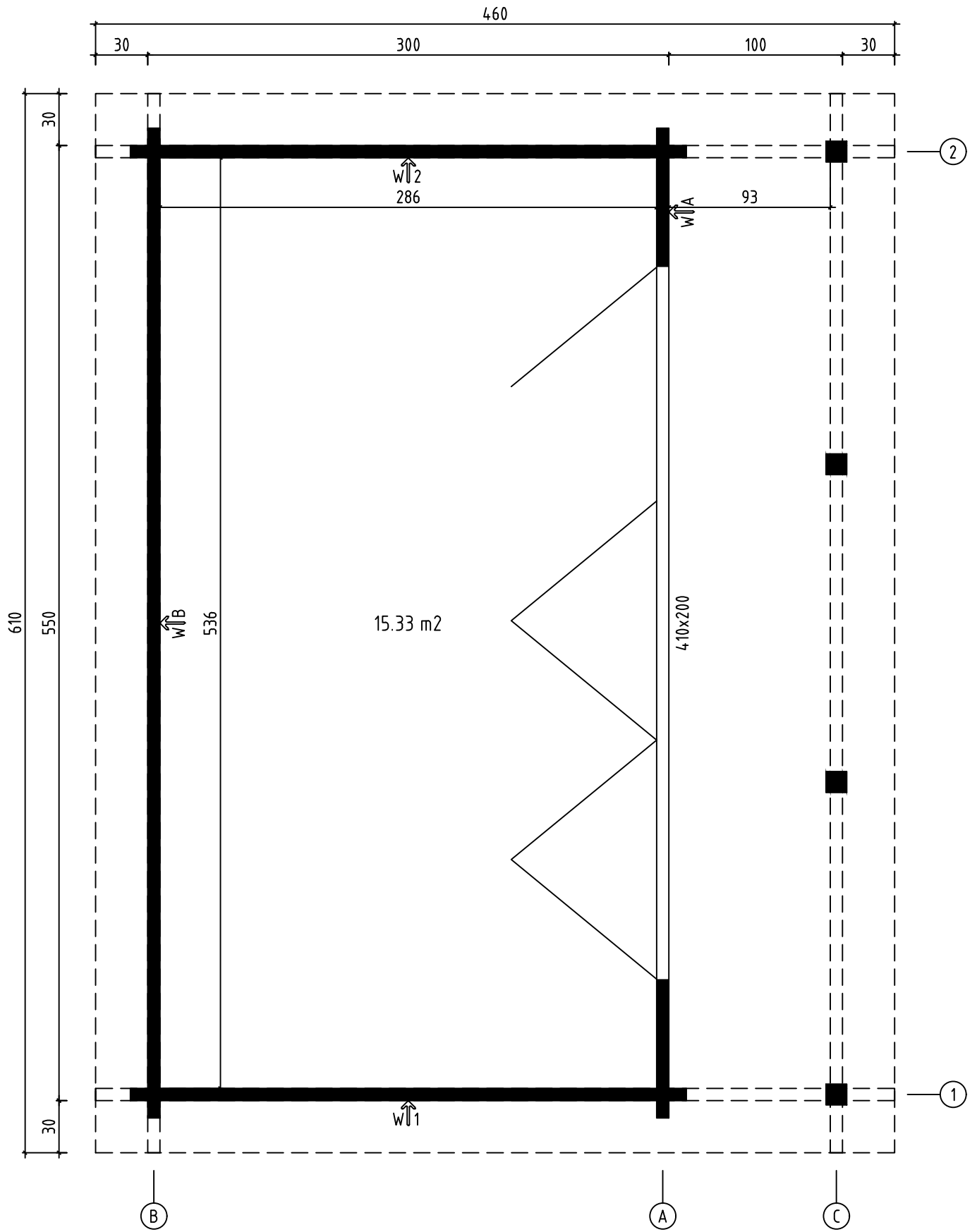



FLOOR BOARDS - FUSSBODENBRETTER - LAME DE PLANCHER  
TERRACE BOARDS - TERRASSENBRETTER - PLANCHER DE TERRASSE

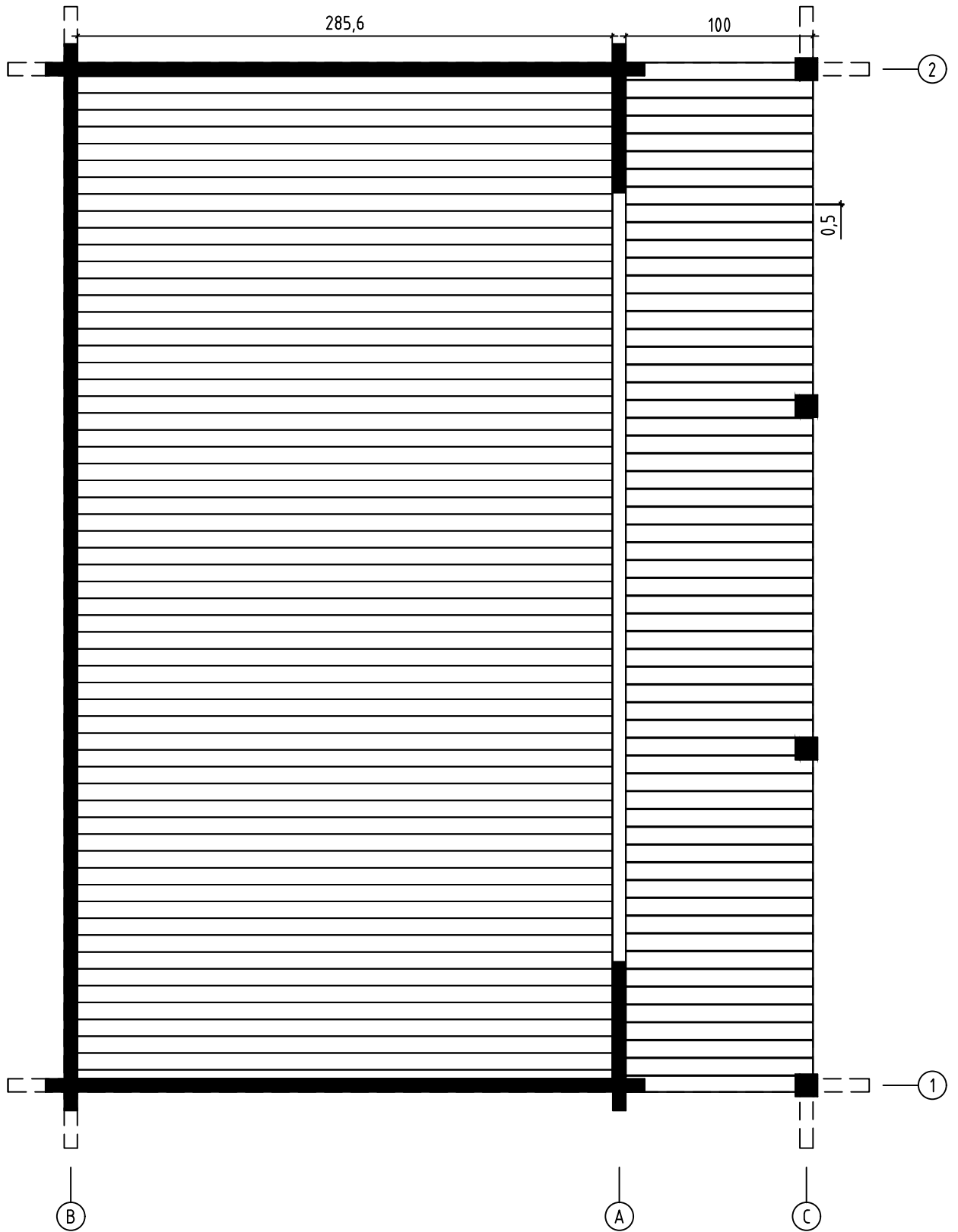

7016344 - Liverpool 1

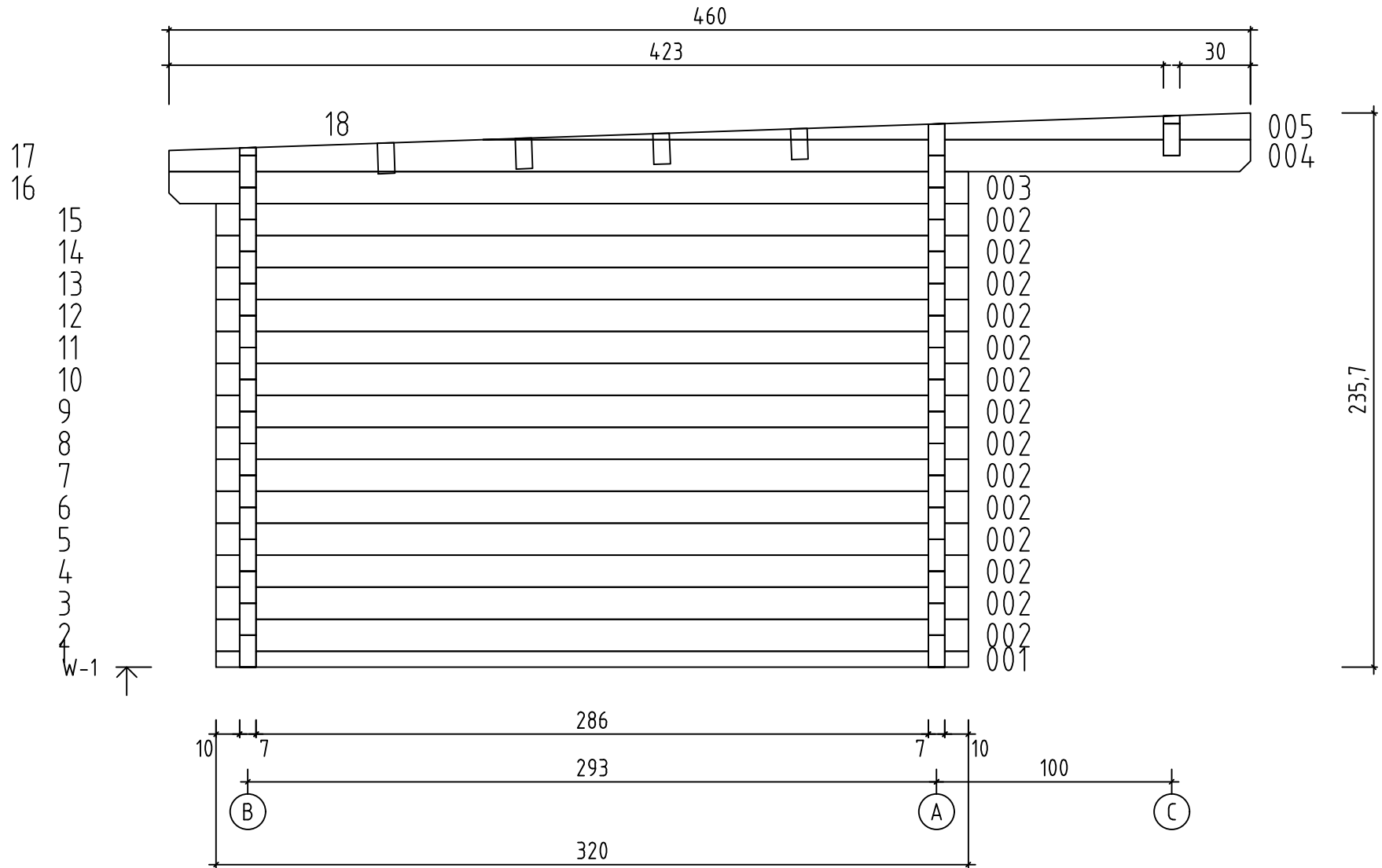

7016344 - Liverpool 1

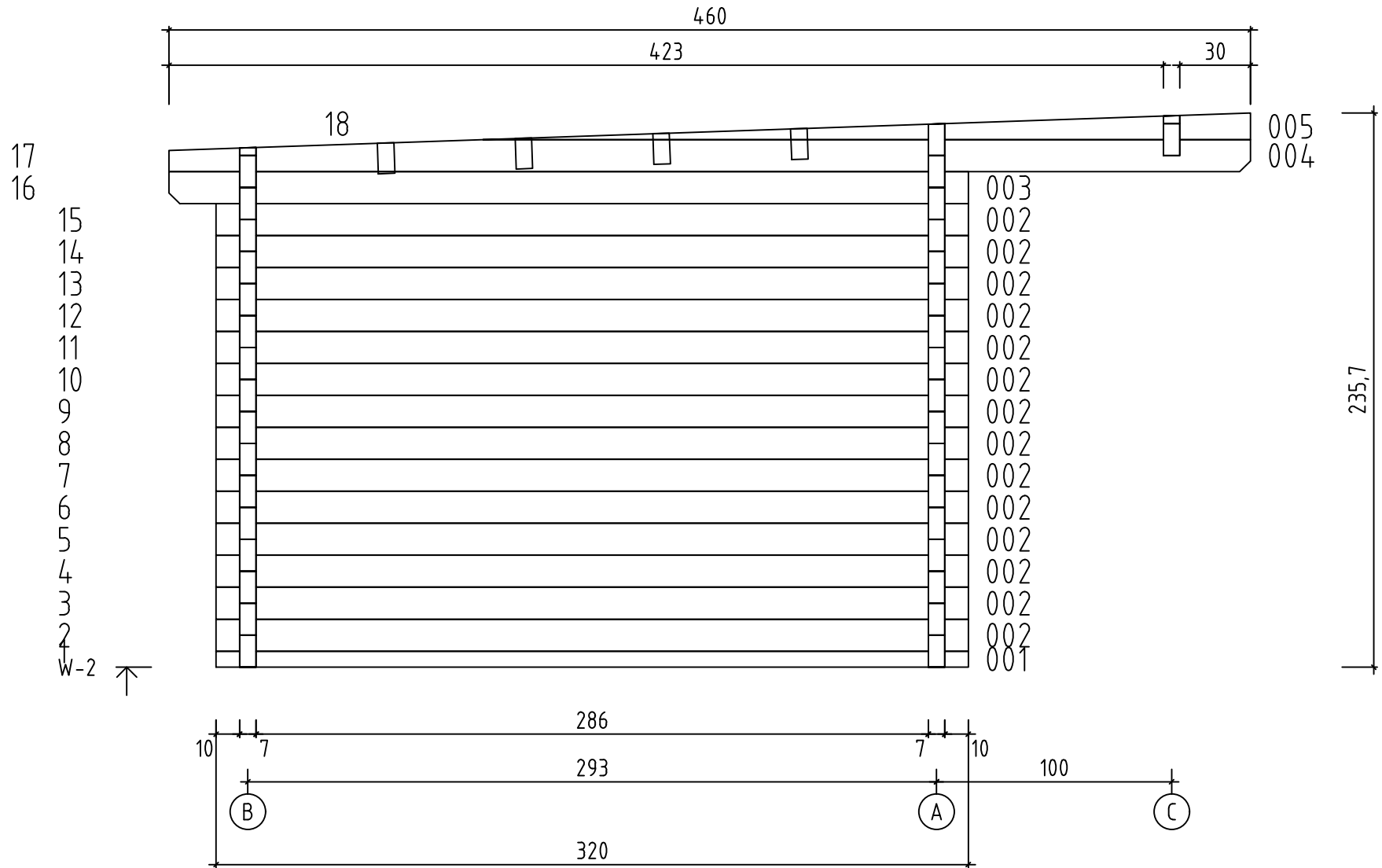



7016344 - Liverpool 1

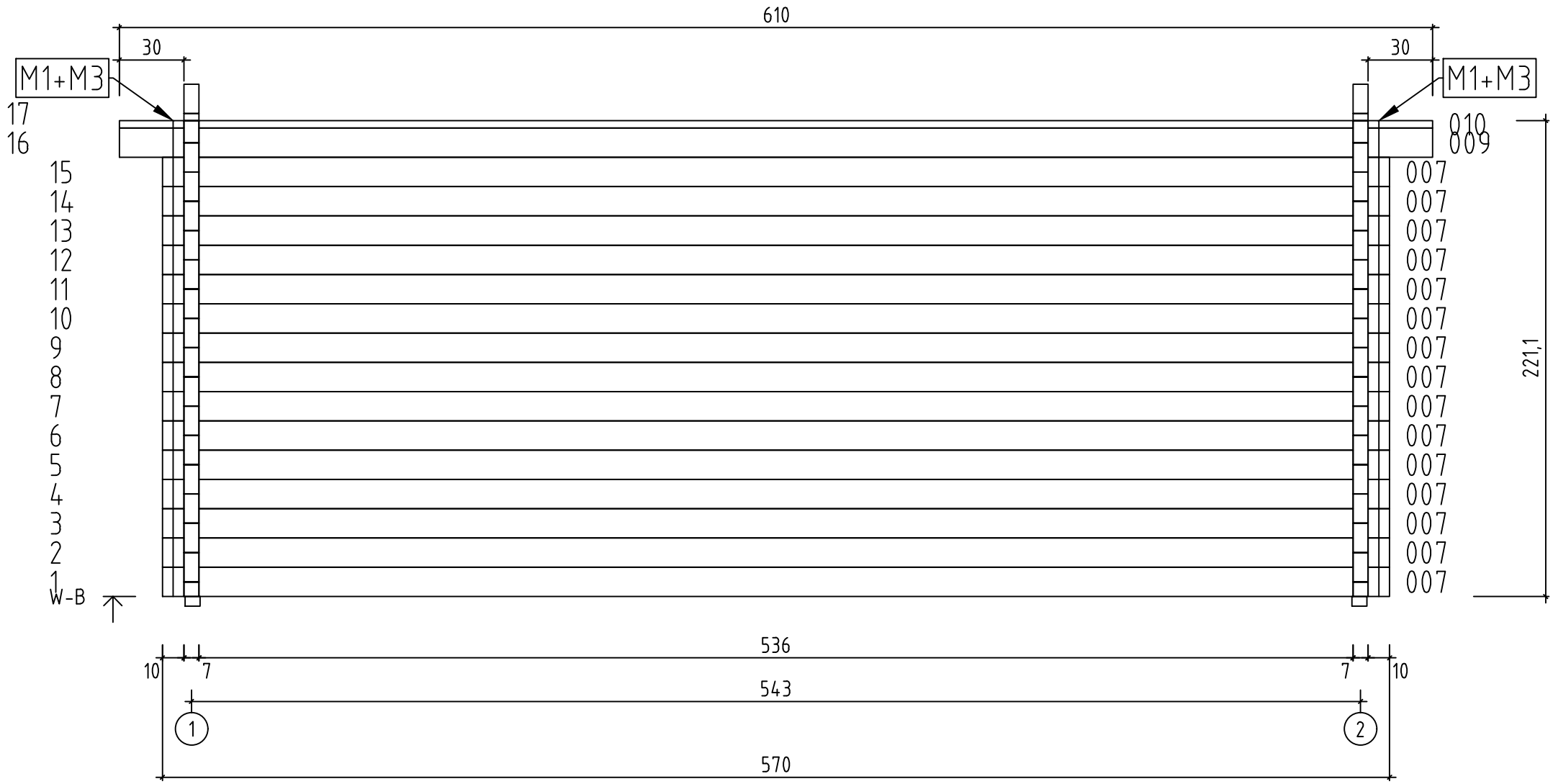





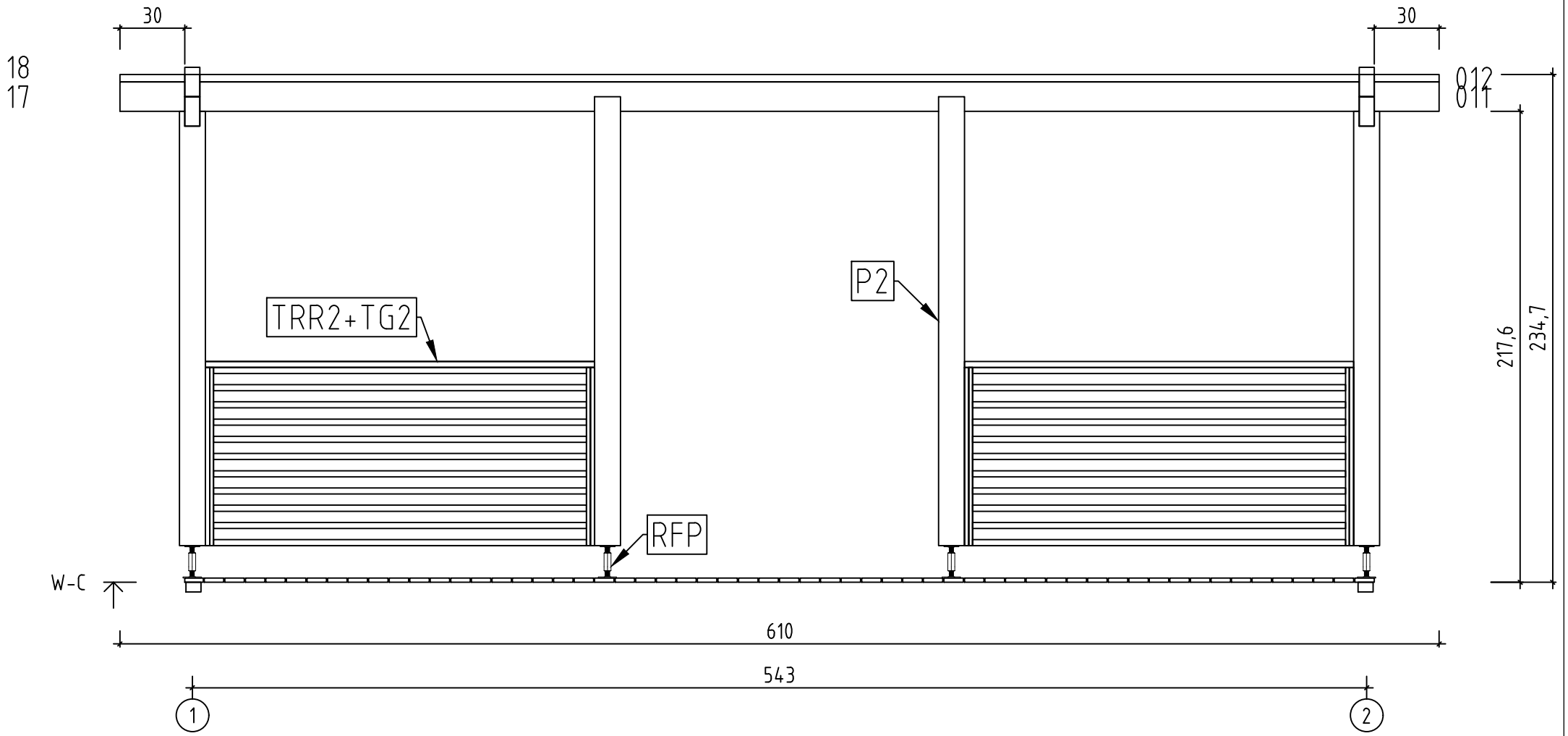



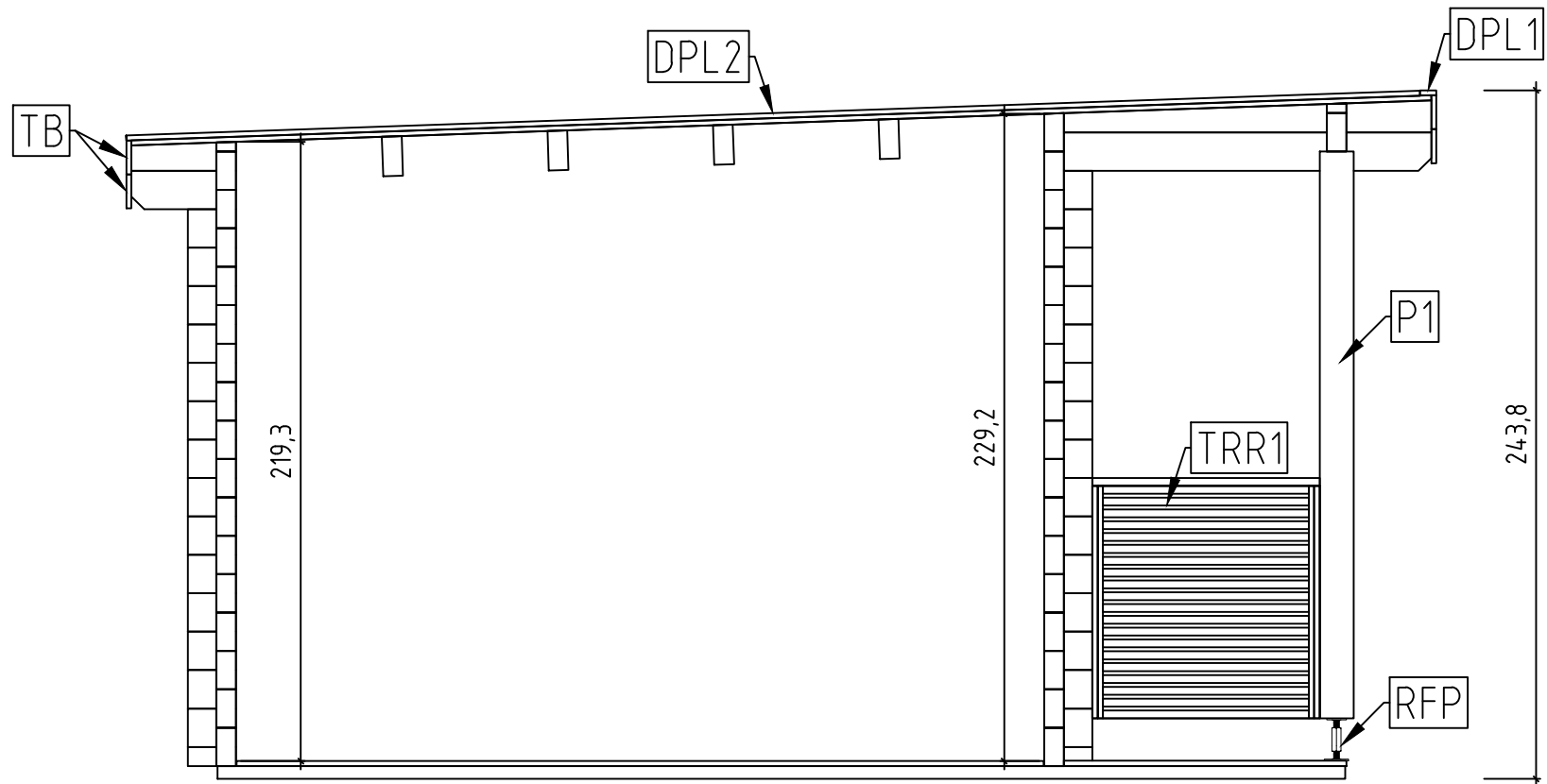

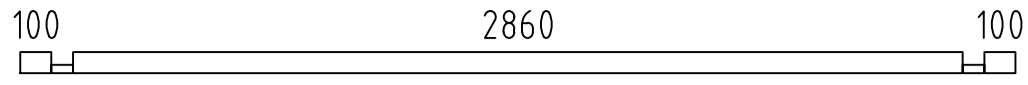
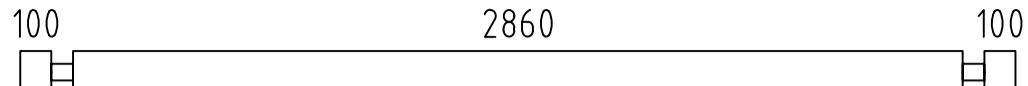
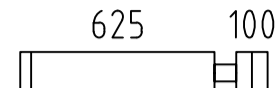
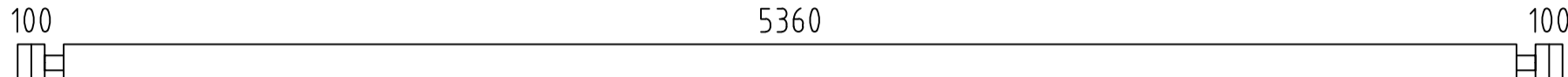
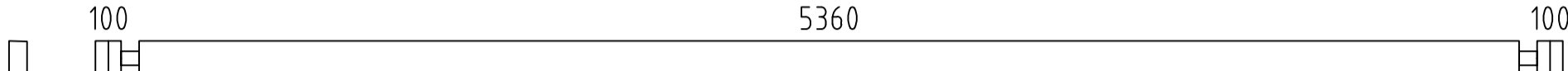
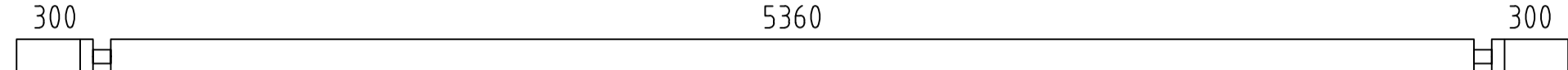

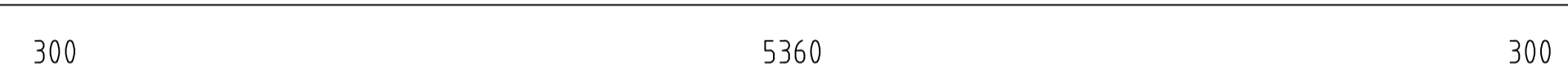

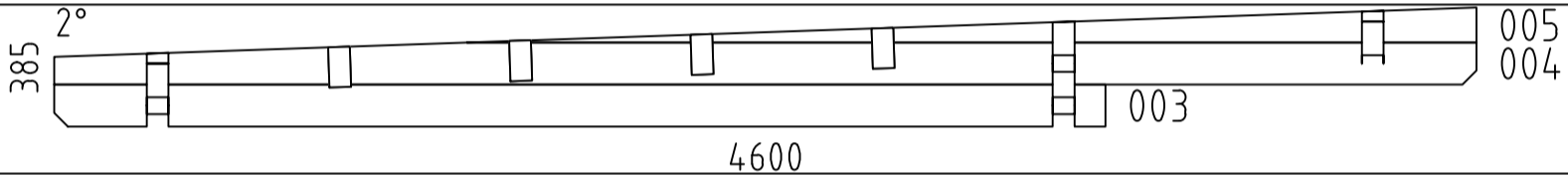
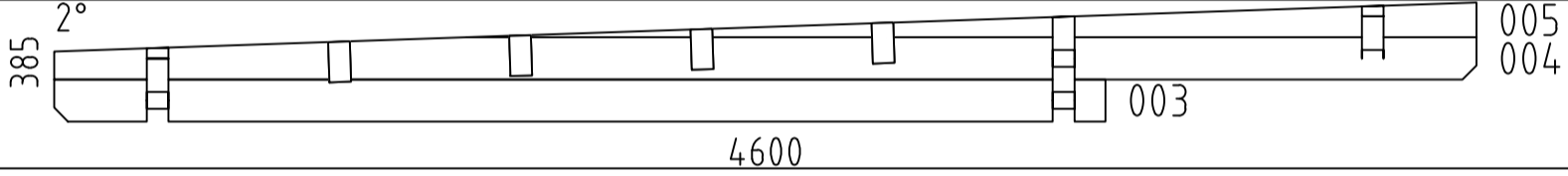
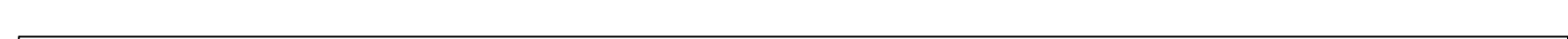

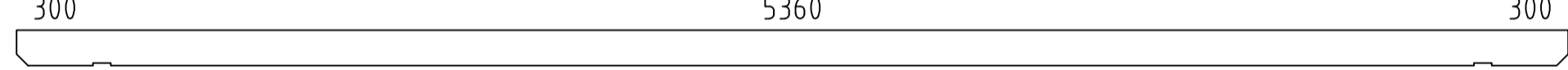
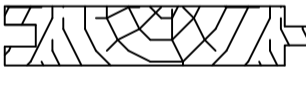
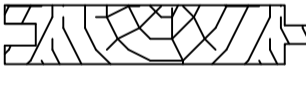
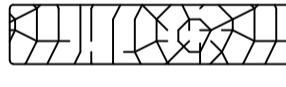

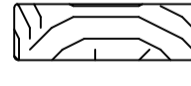
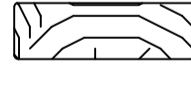
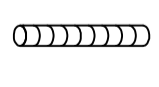
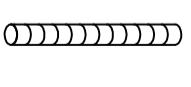
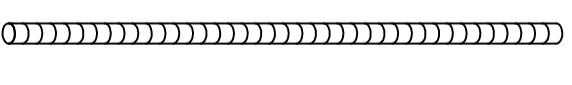
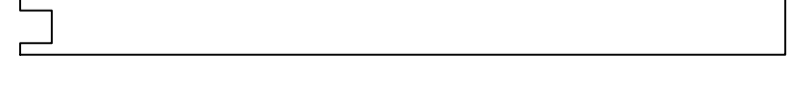
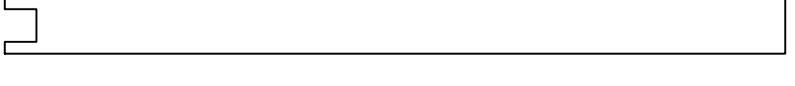

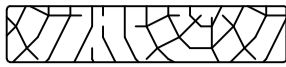
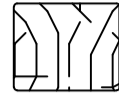
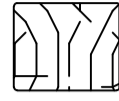
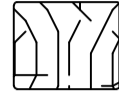
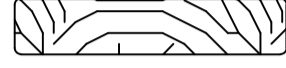

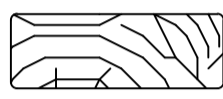
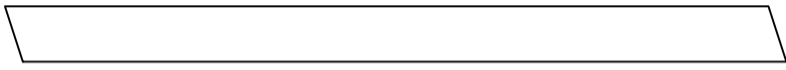
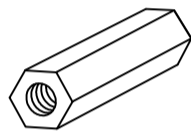
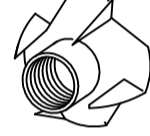
7016344 - Liverpool 1

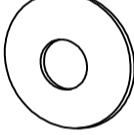
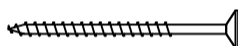
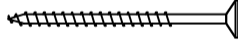
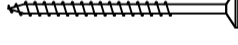
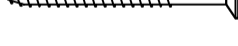





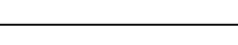
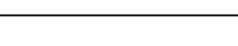



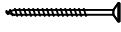
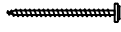

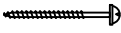
7016344 - Liverpool 1

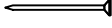

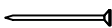
Pos	7016344 - Liverpool 1 Piece list - Stückliste - Liste des pieces	Q.	P (mm)	L (mm)
001		2	70x68	3200
002		28	70x136	3200
006		30	70x136	795
007		16	70x136	5700
008		1	70x136	5700
009		1	70x136	6100
010		1	70x35	6100
011		1	70x136	6100
012		1	70x35	6100
W1-1		1		
W2-1		1		
IAR1	FOUNDATION - FUNDAMENT - FONDATION 	11	70x45	5350
IAR2	FOUNDATION - FUNDAMENT - FONDATION 	2	70x45	3990
A-PR1	ROOF BEAM - DACHBALKEN - PANNE DE TOIT 	4	70x140	6100
FB-1	FLOOR BOARDS - FUSSBODENBRETTER - LAME DE PLANCHER 	60	90x18	2856
RB-1	ROOF BOARDS - DACHBRETTER - VOLIGES 	68	90x18	4603
SV-1	TERRACE BOARDS - TERRASSENBRETTER - PLANCHER DE TERRASSE 	58	90x19	1000
FL-1	FLOOR FILLET-FUSSBODENLEISTE - CORNIERE DE FINITION DU PLANCHER 		18x18	17 m.
DPL1	ROOFING FELT FILLET - DACHPAPPENLEISTE - BAGUETTE DE FIXATION DU FEUTRE BITUMEUX 	2	18x58	3068
DPL2	ROOFING FELT FILLET - DACHPAPPENLEISTE - BAGUETTE DE FIXATION DU FEUTRE BITUMEUX 	2	18x58	4580
M1	TREADED ROD M12 - GEWINDESTANGE M12 - TIGE FILETÉE M12 	2		241
M2	TREADED ROD M12 - GEWINDESTANGE M12 - TIGE FILETÉE M12 	2		342
M3	TREADED ROD M12 - GEWINDESTANGE M12 - TIGE FILETÉE M12 	4		2000
P1	POST - PFOSTEN - POTEAU 	2	120x120	2007
P2	POST - PFOSTEN - POTEAU 	2	120x120	2075

Pos	7016344 - Liverpool 1 Piece list - Stückliste - Liste des pieces		Q.	P (mm)	L (mm)
TB	EAVES BOARD - TRAUFBRETT - BANDEAU DE TOIT		8	18x120	3068
DRV1	ROOF EDGE REINFORCEMENT - DACHRANDVERSTÄRKUNG - CORNIERE DE RENFORT DE BORD DE TOIT		4	28x34	190
DRV2	ROOF EDGE REINFORCEMENT - DACHRANDVERSTÄRKUNG - CORNIERE DE RENFORT DE BORD DE TOIT		4	28x34	3000
TBE1	FIXING FILLET - FIXIRUNGSLEISTE - PROFIL DE FIXATION		2	28x34	2000
TG1	GUARD-RAIL FOR TERRACE - TERRASSEN GELÄNDER - MAIN COURANTE DE TERRASSE		2	28x120	805
TG2	GUARD-RAIL FOR TERRACE - TERRASSEN GELÄNDER - MAIN COURANTE DE TERRASSE		2	28x120	1800
GL8	DISTANCE SPACERS FOR GABLE MOULDING - DACHSTÜZEN - SUPPORTS EXTENSION TOITURE		2	44x95	300
GL	GABLE MOULDING - GIEBELLEISTE - PLANCHE DE RIVE		4	18x120	4607
KL4	LENGTHENING BOLT FOR TREADED ROD - VERLÄNGERUNGSMUTTER FÜR GEWINDESTANGE - MANCHON DE RACCORDEMENT DE TIGE FILETÉE		4		
KL1	DRIVE NUT TREADED ROD - EINSHLAGMUTTER FÜR GEWINDESTANGE - ÉCROU A FRAPPER POUR TIGE FILETÉE		4		
KL2	NUT FOR TREADED ROD - MUTTER FÜR GEWINDESTANGE - ÉCROU POUR TIGE FILETÉE		4		
KL3	PLAIN WASHER TREADED ROD - UNTERLEGSCHLEIBE FÜR GEWINDESTANGE - RONDELLE PLATE POUR TIGE FILETÉE		4		
HS84	SCREW FOR FIXING FILLET - SCHRAUBEN FÜR FIXIRUNGSLEISTE - VIS POUR PROFIL DE FIXATION		10	3.5x50	
HS16	SCREW FOR GABLE MOULDING - SCHRAUBEN FÜR GIEBELLEISTE - VIS DE FIXATION POUR PLANCHE DE RIVE		40	3.5x50	
HS57	SCREW FOR FIXING TERRACE RAILING - SCHRAUBE FÜR TERRASSE - VIS DE FIXATION DE GARDE-CORPS DE TERRASSE		18	4.5x80	
HS45	SCREW FOR SLIDING WALL TIE - SCHRAUBEN FÜR WAND SCHIEBEREGLER - VIS POUR FIXATION ÉQUERRE MÉTALLIQUE AU PARAVENT		8	4x20	
HS32	SCREW FOR EAVES BOARDS - SCHRAUBEN FÜR TRAUFBRETT - VIS DE FIXATION POUR BANDEAU DE TOIT		48	4x40	
HS26	SCREW FOR ROOF EDGE REINFORCEMENT - SCHRAUBEN FÜR DACHRANDVERSTÄRKUNG - VIS POUR RENFORT DE BORD DE TOIT		36	4x40	
HS34	SCREW FOR POST - SCHRAUBEN FÜR PFOSTEN - VIS DE FIXATION DES POTEAUX		8	4x60	
HS30	SCREW FOR TERRACE REAR BOARDS - SCHRAUBEN FÜR TERRASSEN RAND - VIS DE FIXATION POUR MAIN COURANTE DE TERRASSE		18	4x60	
HS40	SCREW FOR 1. WALL BEAM - SCHRAUBE FÜR 1. BOHLENREIHE - VIS DE FIXATION DES FONDATIONS		6	5x120	
HS39	SCREW FOR FUNDAMENT - SCHRAUBEN ZUR BEFESTIGUNG FUNDAMENT - VIS POUR FONDATION		28	5x120	
HS42	SCREW FOR GABLE - SCHRAUBEN FÜR GIEBEL - VIS POUR FIXATION DES PIGNONS		4	5x120	
HS43	SCREW FOR ROOF BEAMS - SCHRAUBEN FÜR DACHBALKEN - VIS POUR PANNE DE TOIT		8	5x120	
HS65	SCREW FOR FIXING GABLE MOULDING DISTANCE SPACERS TO THE WALL - SCHRAUBEN FÜR DACHSTÜZEN - VIS DE SUPPORTS EXTENSION TOITURE		4	5x90	

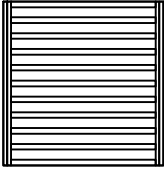
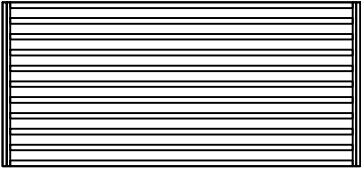
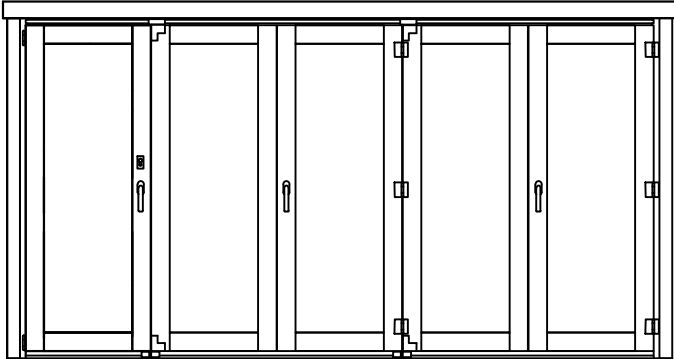
Pos	7016344 - Liverpool 1 Piece list - Stückliste - Liste des pieces	Q.	P (mm)	L (mm)
HS49	SCREW FOR POST HEIGHT ADJUSTMENT - SCHRAUBEN FÜR REGULIERUNGSSCHRAUBE FÜR PFOSTEN - VIS DE FIXATION DE SUPPORT RÉGLABLE DE POTEAU 	32	6x50	
MS	SCREW FOR DOORSTEP - SCHRAUBEN FÜR TÜRSCHWELLE - VIS DE FIXATION DU SEUIL DE PORTE 	5	4.5x65	
NF3	SCREW FOR TERRACE BOARD - SCHRAUBEN FÜR TERRASSENBRETT - VIS POUR LAME DE SEUIL D'ENTREE DE TERRASSE 	348	4.2x55	
HS72	SCREW FOR SLIDING WALL TIE - SCHRAUBEN FÜR WAND SCHIEBEREGLER - VIS POUR FIXATION ÉQUERRE MÉTALLIQUE AU PARAVENT 	2	5x60	
SH70	HAMMER BLOCK - SCHLAGHOLZ - CALLE DE FRAPPE 	2		
NFD	ZN NAIL FOR ROOFING FELT FILLET - ZN NÄGEL FÜR DACHPAPPENLEISTE - POINTE POUR BAGUETTE FIXATION FEUTRE BITUMEUX 	38	2x40	
NFF	ZN NAIL FOR FLOOR FILLETS - ZN NÄGEL FÜR FUSSBODENLEISTEN - POINTE POUR PANNEAUX DE PLANCHER 	34	1.4x40	
NF2	ZN NAIL FOR ROOF - ZN NÄGEL FÜR DACHBRETT - POINTE POUR TOIT 	497	2.1x50	
NH1	ZN NAIL FOR FLOOR - ZN NÄGEL FÜR FUSSBODENBRETT - CLOUS POUR PLANCHER 	366	2.1x50	
ORZ	MONTAGE SET FOR DOORS AND WINDOWS - MONTAGE-SET FÜR TÜREN UND FENSTER - JEU DE MONTAGE PORTES ET FENETRES	1		
KL5	PLAIN WASHER FOR SLIDING WALL TIE - UNTERLEGSCHIEBE FÜR WAND SCHIEBEREGLER - RONDELLE POUR SABOT MÉTALLIQUE 	2		
WLGR	SLIDING WALL TIE - SCHIEBEREGLER FÜR WAND - EQUERRE MÉTALLIQUE DE FIXATION DU PARAVENT 	2		
RFP	POST HEIGHT ADJUSTMENT - REGULIERUNGSSCHRAUBE FÜR PFOSTEN - SUPPORT RÉGLABLE DE POTEAU 	4		
TRR1	TERRACE RAILING - TERRASSE - GARDE-CORPS DE TERRASSE 	2		805
TRR2	TERRACE RAILING - TERRASSE - GARDE-CORPS DE TERRASSE 	2		1800
	DOOR-TÜR-PORTE  4100X2000 3+	1		

