

Charnwood 5
Art. Nr. 4431819

1/8

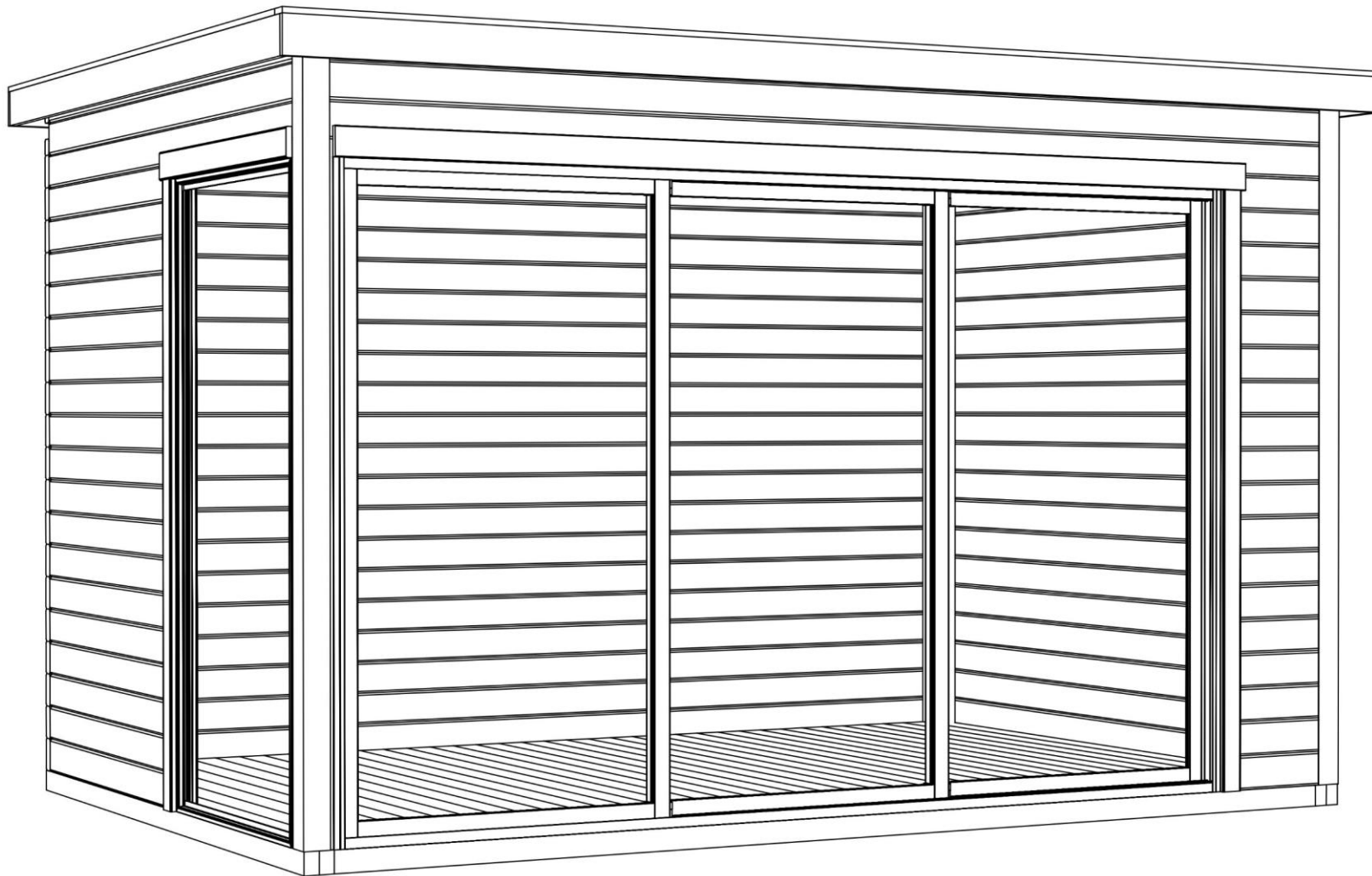

28.08.2023

Art.Nr. 4431819

Groundplan - Grundplan - Plan de masse -
Planimetria - Plattegrond - Põhiplaan

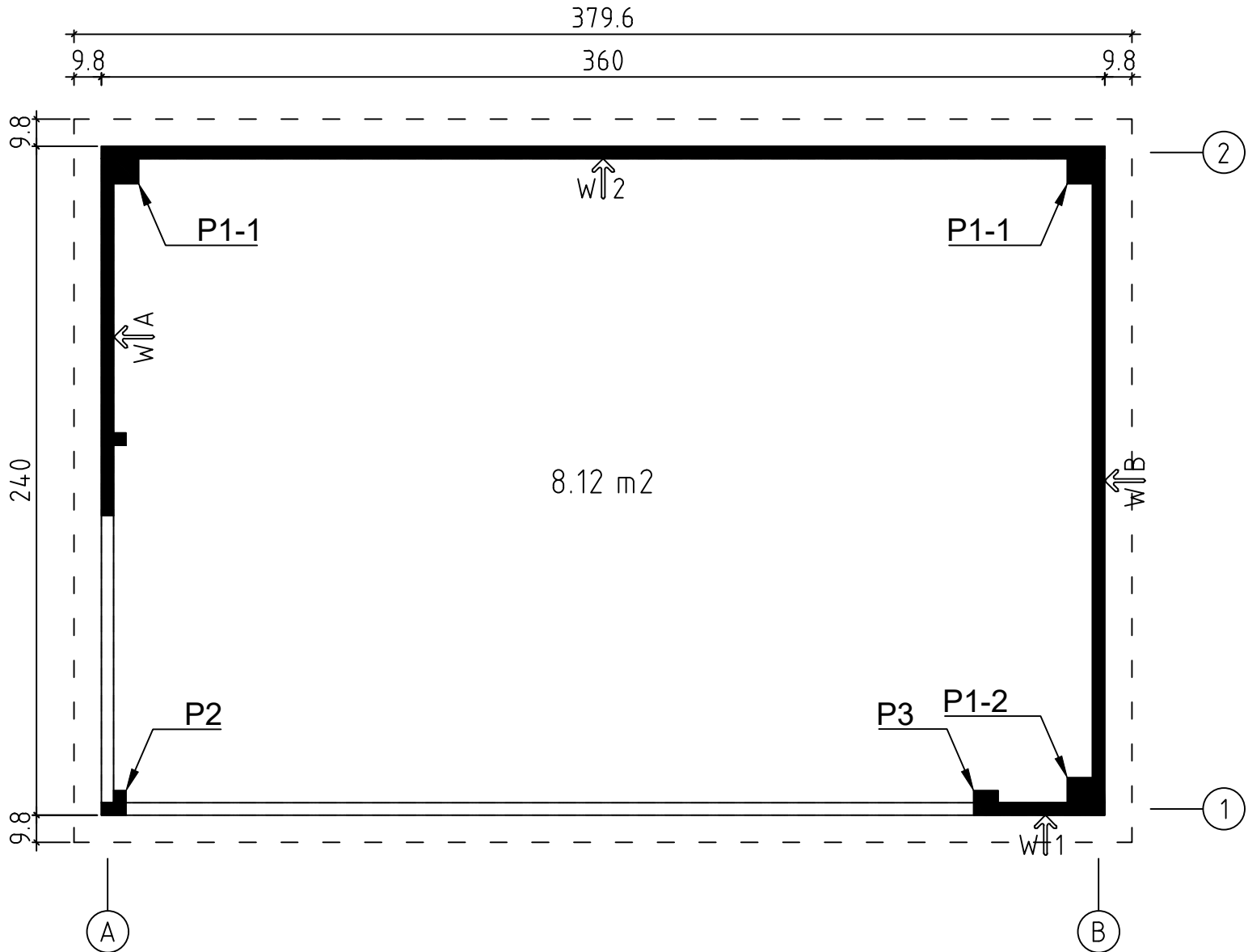

Art.Nr. 4431819





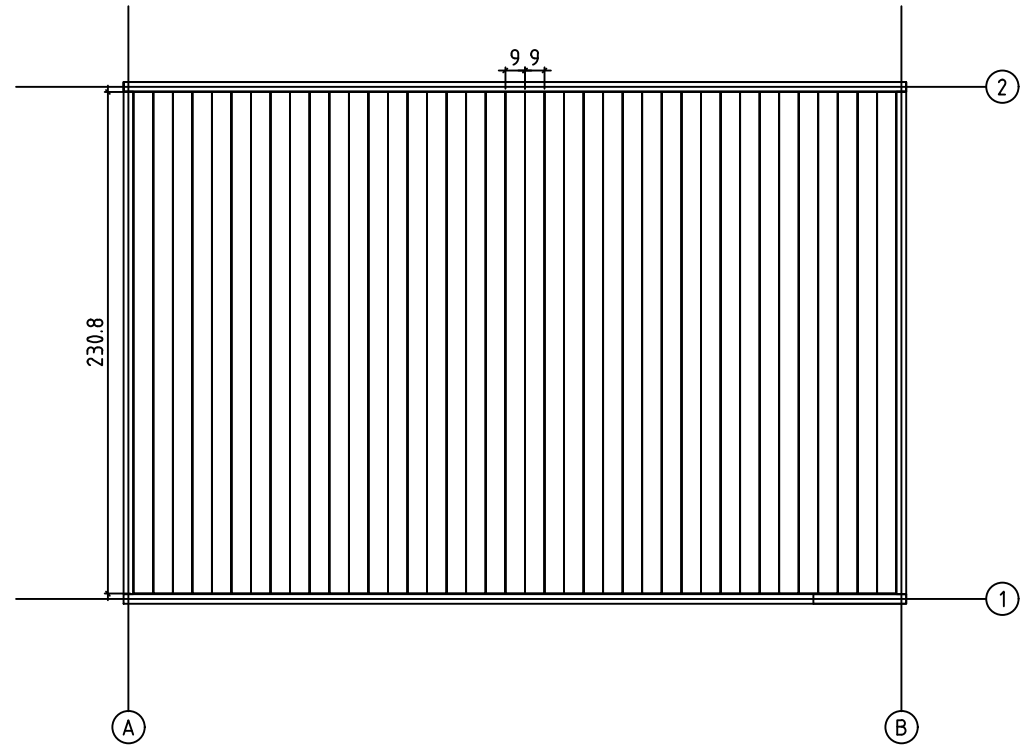
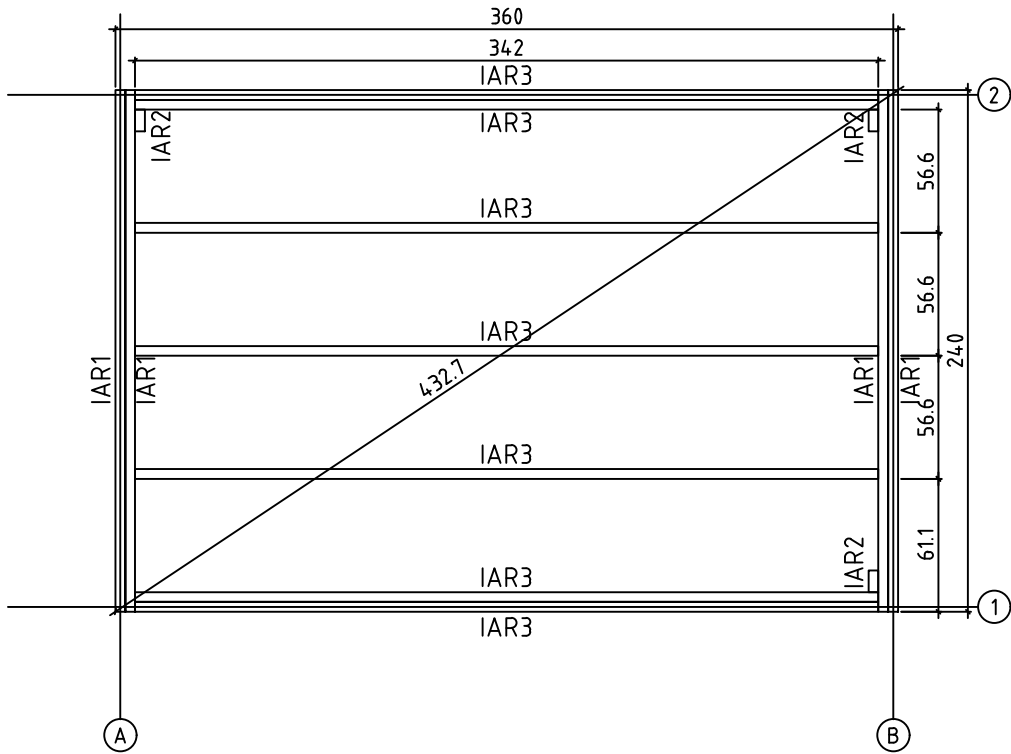

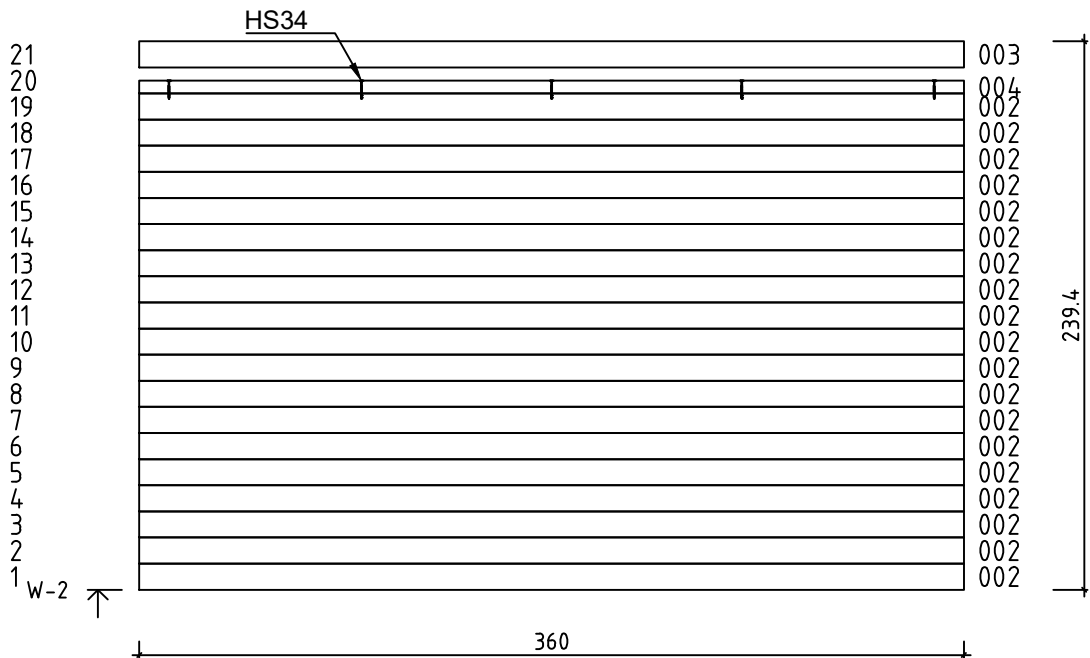
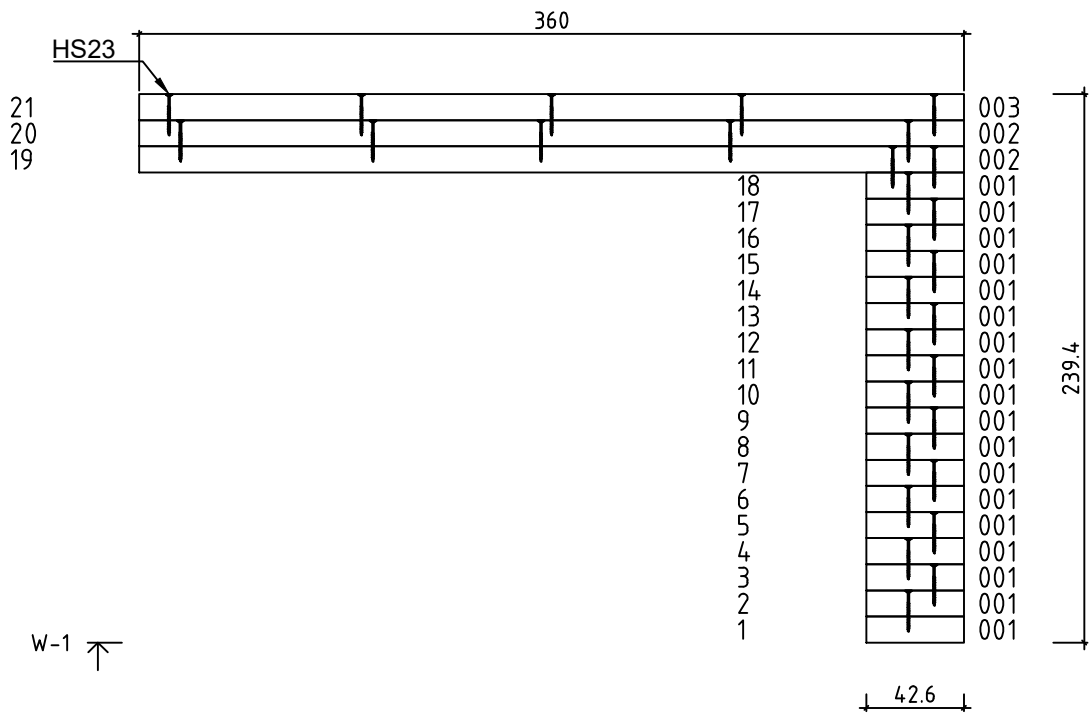

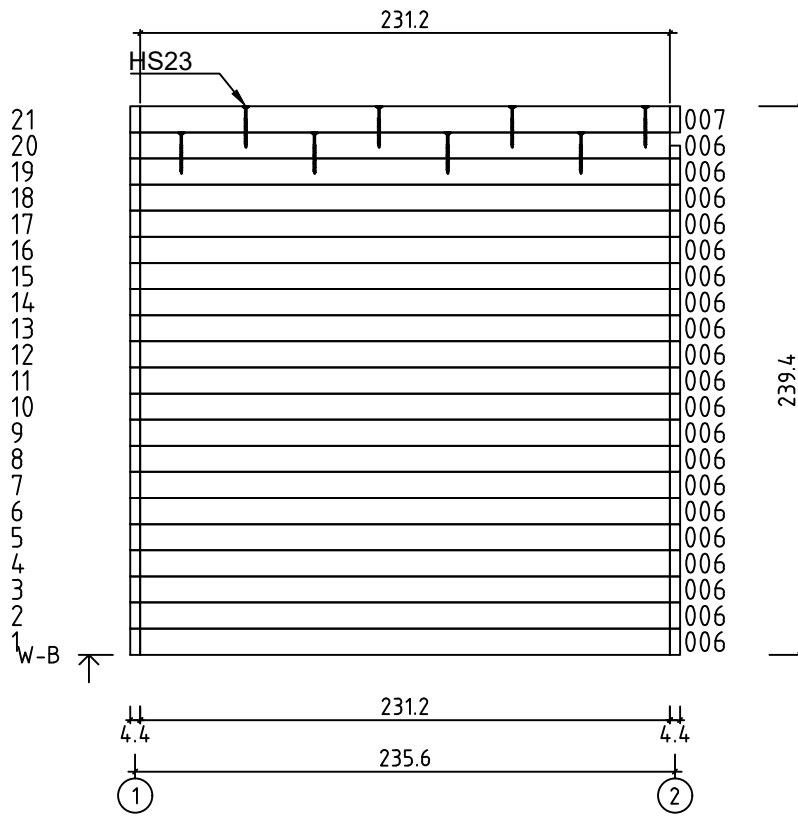
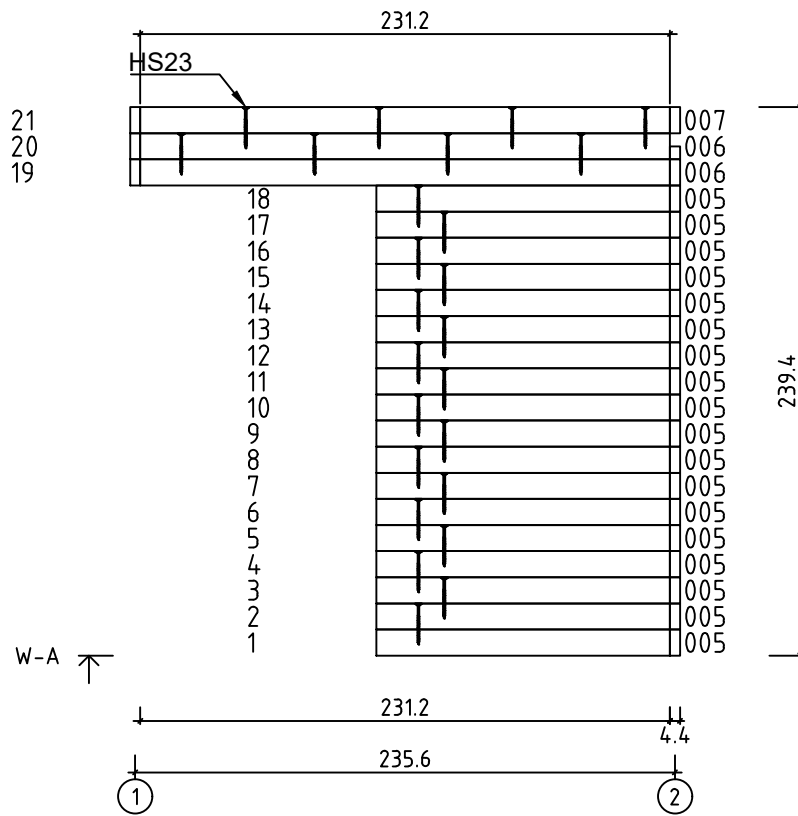
Foundation - Fundament - Fondation - Fundamenta -
Fundering - Bastidor - Immutatud alusraam

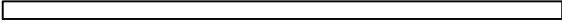
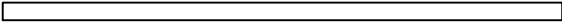
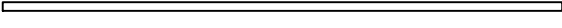
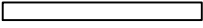
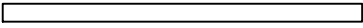
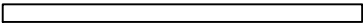
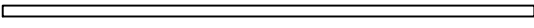
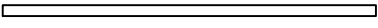

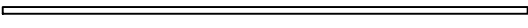
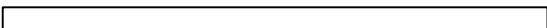





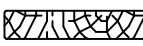
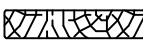
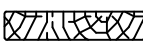
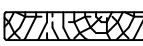
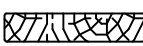
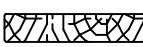

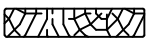
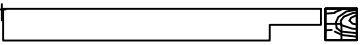
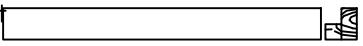



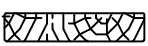
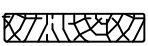





Floor boards - Fussbodenbretter - Plan pose plancher - Pavimento -
Vloerhout - Tarima de suelo - Põrandalaudis











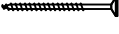
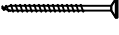
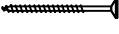
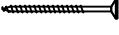
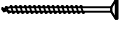
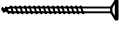

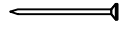
Pos	28.08.2023	Piece list - Stückliste - Liste des pièces - Elementi - Stuklijst - Tükítabel Art.Nr. 4431819	6/8	Arv	Profiil (mm)	Pikkus (mm)
001 46567				18	44x114	426
002 43287				21	44x114	3600
003 46568				2	44x114	3600
004 46569				1	44x57	3600
005 45767				18	44x114	1281
006 46570				22	44x114	2312
007 46571		Foundation - Fundament - Fondation - Fondamenta - Fundering - Bastidor - Immutatud alusraam		2	44x114	2312
IAR3 37935		Foundation - Fundament - Fondation - Fondamenta - Fundering - Bastidor - Immutatud alusraam		7	45x70	3420
IAR1 29275				4	45x70	2400
IAR2 34041		Foundation - Fundament - Fondation - Fondamenta - Fundering - Bastidor - Immutatud alusraam		3	45x70	100
RV1 46572		Lath - Pfetten - Liteau - Piccola asse - Gordingen - Vigüeta - Roov		1	44x44	3378
A-PR1 46552		Roof beam - Dachbalken - Panne de toit - Perlina del tetto - Gordingen / dakbalk - Correa - Pärtin		3	44x140	3504
FB-1 23132	Floor boards - Fussbodenbretter - Lame de plancher - Pavimento - Vloerhout - Põrandalaud			39	90x18	2308
RB-1 3014	Roof boards - Dachbretter - Voliges - Perlina per tetto - Dakhout - Katuselaud			40	90x18	2400
FL-1 30087	Floor fillet - Fussbodenleiste - Corniere de finition du plancher - Finitura per pavimento (battisco pa) - Vloerafwerkljst - Põrandaliist				18x18	13
DPL-1 46523	Roofing felt fillet - Dachpappenleiste - Baguette de fixation du feutre bitumeux - Asse per fissaggio guaina bituminosa - Afdeklijst asfaltpapier - Katusepapiliist			2	18x58	2538
DPL-2 46554	Roofing felt fillet - Dachpappenleiste - Baguette de fixation du feutre bitumeux - Asse per fissaggio guaina bituminosa - Afdeklijst asfaltpapier - Katusepapiliist			1	18x58	3796
RS1 37808	Railing strip - Begrenzungsleiste - Rembarde - Sbarra - Afscheidingslijst - Piirdelaud			1	18x70	1975
RS3 37810	Railing strip - Begrenzungsleiste - Rembarde - Sbarra - Afscheidingslijst - Piirdelaud			1	18x70	1993
RS2 35597	Railing strip - Begrenzungsleiste - Rembarde - Sbarra - Afscheidingslijst - Piirdelaud			1	18x70	2000
RS5 37811	Railing strip - Begrenzungsleiste - Rembarde - Sbarra - Afscheidingslijst - Piirdelaud			1	18x90	1065
RS6 37812	Railing strip - Begrenzungsleiste - Rembarde - Sbarra - Afscheidingslijst - Piirdelaud			1	18x90	1075
RS11 38457	Railing strip - Begrenzungsleiste - Rembarde - Sbarra - Afscheidingslijst - Piirdelaud			1	18x90	3039

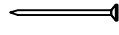
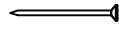
Pos	28.08.2023 Piece list - Stückliste - Liste des pièces - Elementi - Stuklijst - Tükítabel Art.Nr. 4431819 7/8	Arv	Profiil (mm)	Pikkus (mm)
RS12 38012	Railing strip - Begrenzungsleiste - Rembarde - Sbarra - Afscheidingslijst - Piirdelaud 	1	18x90	3125
P4 37960	Post - Pfosten - Poteau - Piede registrabile - Stijl - Post 	1	88x88	2330
P5 42378	Post - Pfosten - Poteau - Piede registrabile - Stijl - Post 	1	88x88	2052
P1 31654	Post - Pfosten - Poteau - Piede registrabile - Stijl - Post 	1	44x44	2260
P2 39319	Post - Pfosten - Poteau - Piede registrabile - Stijl - Post 	2	90x90	2220
P3 41820	Post - Pfosten - Poteau - Piede registrabile - Stijl - Post 	1	90x90	2330
TB1 46521	Fascia board - Traufbrett - Bandeau de toit - Finitura lati tetto - Gevellijst Räästalaud 	2	18x120	2560
TB2 46555	Fascia board - Traufbrett - Bandeau de toit - Finitura lati tetto - Gevellijst Räästalaud 	2	18x120	3796
DRV-1 46522	Roof edge reinforcement - Dachrandverstärkung - Corniere de renfort de bord de toit - Rinforzo x tetto - Dakrand versterking - Räästatugevdus 	2	80x44	2560
DRV-2 46553	Roof edge reinforcement - Dachrandverstärkung - Corniere de renfort de bord de toit - Rinforzo x tetto - Dakrand versterking - Räästatugevdus 	2	80x44	3600
FF6 38454	Fixing fillet - Fixierungsleiste - Profil de fixation - Massello di fissaggio - Bevestiging lijstwerk - Tenderliist 	1	11x30	2998
FF 28448	Fixing fillet - Fixierungsleiste - Profil de fixation - Massello di fissaggio - Bevestiging lijstwerk - Tenderliist 	2	15x45	2026
FF4 37816	Fixing fillet - Fixierungsleiste - Profil de fixation - Massello di fissaggio - Bevestiging lijstwerk - Tenderliist 	1	38x46	2026
FF7 38464	Fixing fillet - Fixierungsleiste - Profil de fixation - Massello di fissaggio - Bevestiging lijstwerk - Tenderliist 	1	38x46	2998
HS32 5107	Screw for door jamb - Schraube für türrahmen - Vis de fixation partie haute avec montants du cadre de porte - Viti x fissaggio montanti porte - Schroef voor deurkozijn - Kruvi ukse lengile 	12	4.5x25	
HS12 5109	Screw for metal corner - Holzschraube für metallwinkel - Vis de fixation des cornieres en métal - Viti per fissare suadretta di metallo di giunzione - Schroef voor metalen hoek - Kruvi nurgikule 	20	4x40	
HS12 5109	Screw for covering moulding - Schrauben für deckungsprofil - Vis de fixation profils horizontaux haut intérieur et extérieur d'encadrement de porte - Vite per cornice di copertura - Schroef voor afdekprofiel - Kruvi piirdelauale 	34	4x40	
HS12 5109	Screw for fascia boards - Schrauben für traufbretter - Vis pour fixation bandeau de toit - Viti x striscia del tetto - Schroef voor gevellijst - Kruvi räästalauale 	32	4x40	
HS12 5109	Screw for beam holder - Schrauben für balkenhalter - Vis de fixation support "u" galvanisé - Vite per trave di sostegno - Schroef voor bevestiging balkhouder (gordingschoen) - Kruvi talakingale 	72	4x40	
HS12	Screw for fixing fillet of door and window - Schrauben für fixierungsleiste - Vis pour profil vertical de fixation pour ouvertures des fenestres et portes - Viti per massello di fissaggio - Schroeven voor bevestiging van deur en raam lijsten - Kruvi tenderliistufudele 	3	4x40	
HS12 5109	Screw for door jamb - Schraube für türrahmen - Vis de fixation partie haute avec montants du cadre de porte - Viti x fissaggio montanti porte - Schroef voor deurkozijn - Kruvi ukse lengile 	10	4x40	
HS33 5112	Screw for door jamb - Schraube für türrahmen - Vis de fixation partie haute avec montants du cadre de porte - Viti x fissaggio montanti porte - Schroef voor deurkozijn - Kruvi ukse lengile 	12	5x40	
HS34 40958	Screw for wall details - Schraube für wand details - Vis pour mur details - Viti per elementi della porta - Schroef voor wand details - Kruvi seinte montaaziks 	350	5x80	

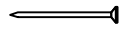
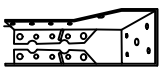
Pos	28.08.2023 Piece list - Stückliste - Liste des pièces - Elementi - Stuklijst - Tükitalabel Art.Nr. 4431819 8/8	Arv	Profiil (mm)	Pikkus (mm)
HS16 5115	Screw for door jamb - Schraube für Türrahmen - Vis de fixation partie haute avec montants du cadre de porte - Viti x fissaggio montanti porte - Schroef voor deurkozijn - Krugi ukse lengile 	3	5x90	
HS16 5115	Screw for foundation - Schrauben zur Befestigung Fundament - Vis de fixations des poutrelles de fondations - Viti x fondamenta - Schroef voor fundering - Krugi alusraamile 	30	5x90	
HS16 5115	Screw for post - Schrauben für Pfosten - Vis de fixation des poteaux - Viti per inviare - Schroef voor stijlen - Krugi postile 	9	5x90	
HS16 5115	Screw for roof edge reinforcement - Schrauben für Dachrandverstärkung - Vis pour fixation corniere renfort de bord de toit - Viti x rinforzo bordo tetto - Schroef voor dakrand versterking - Krugi räästatugevdusele 	32	5x90	
HS16 5115	Screw for door jamb - Schraube für Türrahmen - Vis de fixation partie haute avec montants du cadre de porte - Viti x fissaggio montanti porte - Schroef voor deurkozijn - Krugi ukse lengile 	9	5x90	
HS22 5120	Screw for 1. wall beam - Schraube für 1. Bohlenreihe - Vis de fixations 1ere rangée de madriers avec poutrelles de fondations - Vite fissaggio alle fondamenta - Schroef voor 1 wandbalk - Krugi poollauale 	11	6x150	
HS23 5121	Screw for wall details - Schraube für Wand details - Vis pour mur details - Viti per elementi della porta - Schroef voor wand details - Krugi seinadetailidele 	77	6x180	
NF2 5127	Zn nail for floor fillet - Zn Nägel für Fussbodenleiste - Pointe pour corniere de finition du plancher - Chiodi x fissaggio pavimento - Spijker(nagel) voor vloer afdekljst - Nael põrandaliistule 	26	1.4x40	
SH44 32512	Hammer block - Schlagholz - Calle de frappe - Blocco di legno da usare come cuscinetto quando si usa il martello - Slagklos - Löögiklots 	1		
NF4 5137	Zn nail for roof - Zn Nägel für Dachbretter - Pointe pour fixation voliges de toit - Chiodi x perline tetto - Spijker(nagel) voor dakhout - Nael katuselauale 	400	2x50	
NF4 5137	Zn nail for floor - Zn Nägel für Fussbodenbretter - Clous pour plancher - Chiodi x perline pavimento - Spijker(nagel) voor vloer - Nael põrandalauale 	205	2x50	
MW 5141	Metal corner - Metallwinkel - Corniere en métal - Angolo di metallo - Metalen hoek - Nurgik 	2	120x80x40	
NF5 5145	Zn nail for roofing felt fillet - Zn Nägel für Dachpappenleiste - Pointe pour baguette de fixation feutre bitumeux - Chiodi x carta bituminosa x tetto - Spijker(nagel) voor asfaltpapier afdekljst - Papiliistunael 	18	2x40	
BM 37607	Beam holder - Balkenhalter - Support en u galvanisé - Supporto della trave - Balkendrager (gording schoen) - Talaking 	6	45x137	
	To prevent splits in the wood, we recommend pre-drilling screw holes. Um der Rissbildung im Holz vorzubeugen, empfehlen wir, die Schraubenlöcher vorzubohren. Afin d'éviter le risque de fissuration du bois nous recommandons de percer auparavant les trous des vis. Per impedire avvitando le viti autofilettanti dell'insorgere di crepe nel legno, si consiglia di pre forare il legno con un trapano. Om scheuren van het hout te voorkomen, adviseren we om schroefgaten voor te boren. Ennetamaks puidu lõhenemist, soovitame kruviaugud ette puurida.			

Art. Nr. 4431819

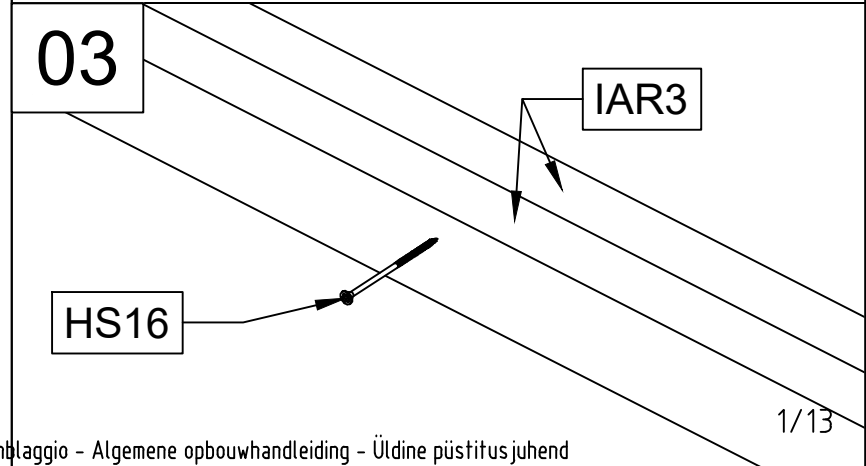
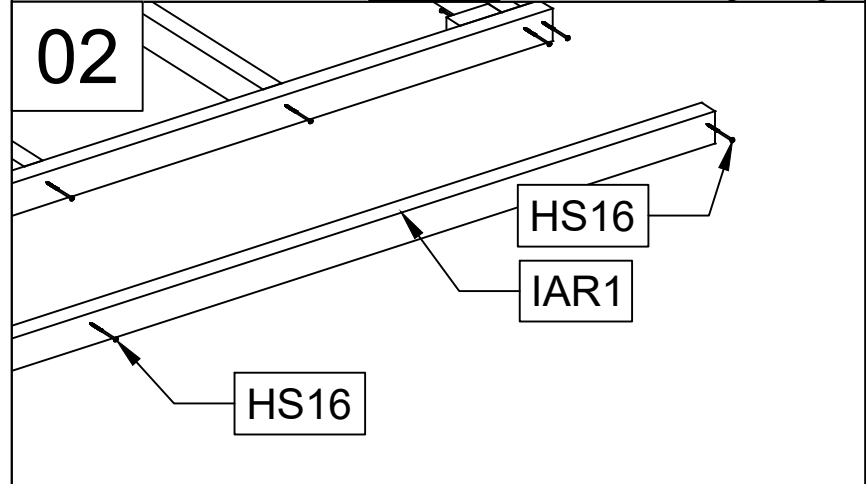
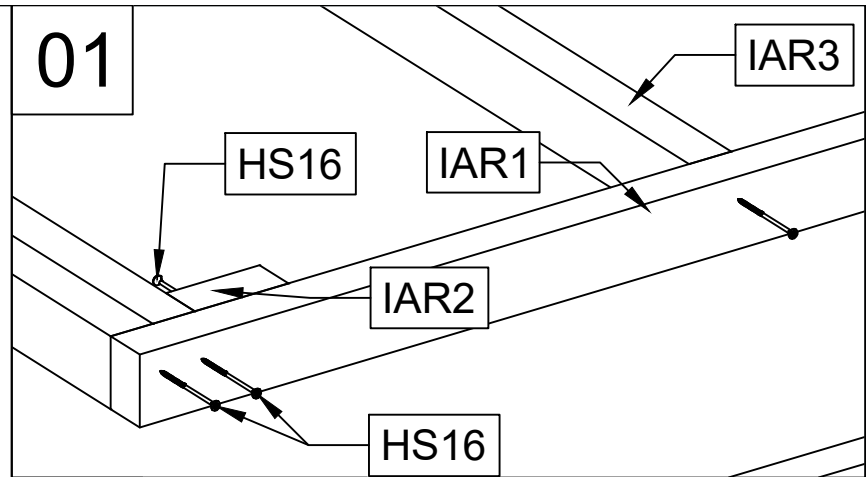
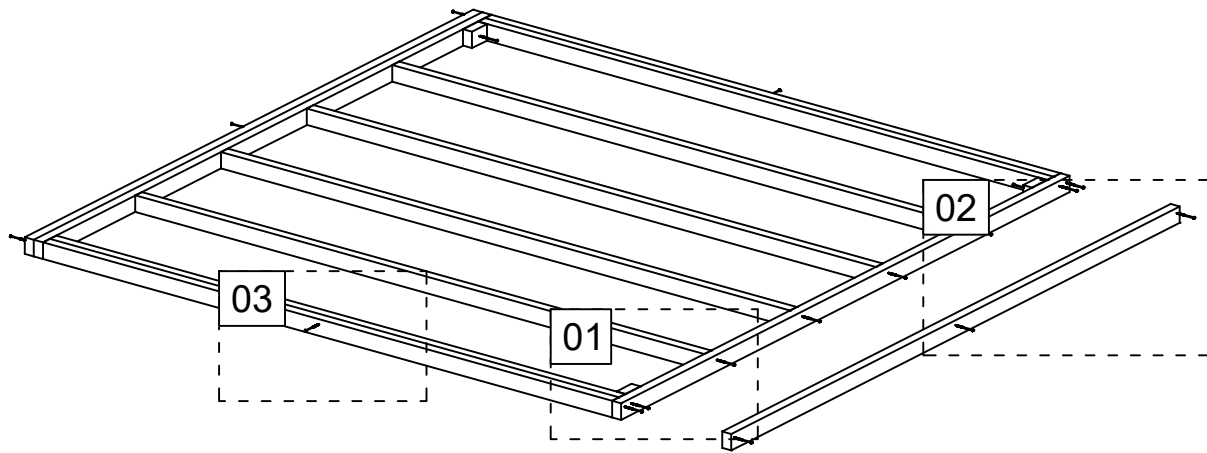

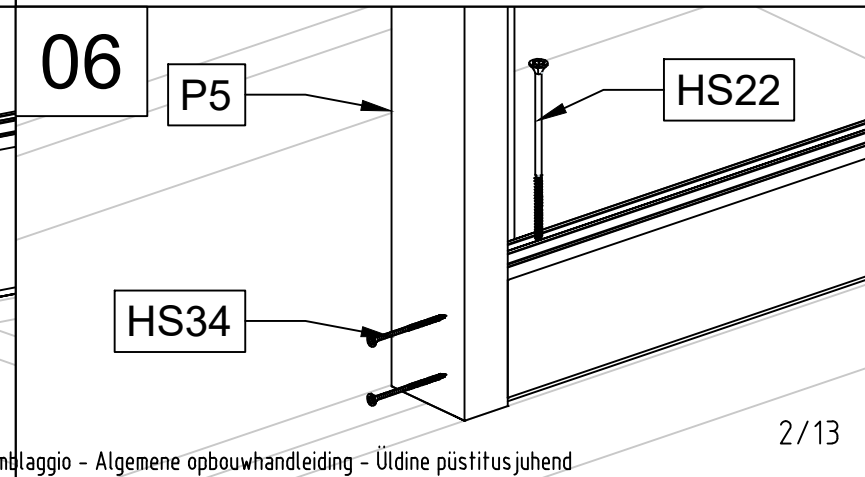
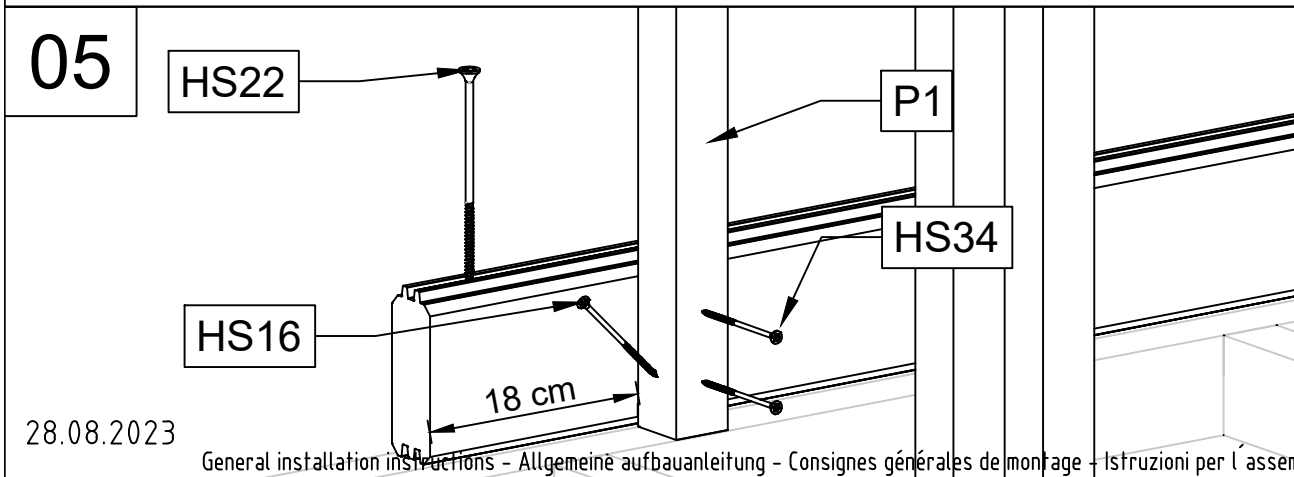
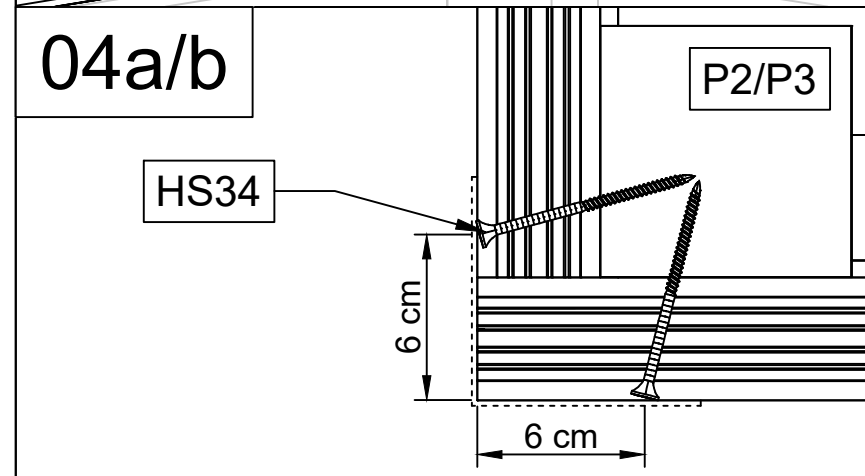
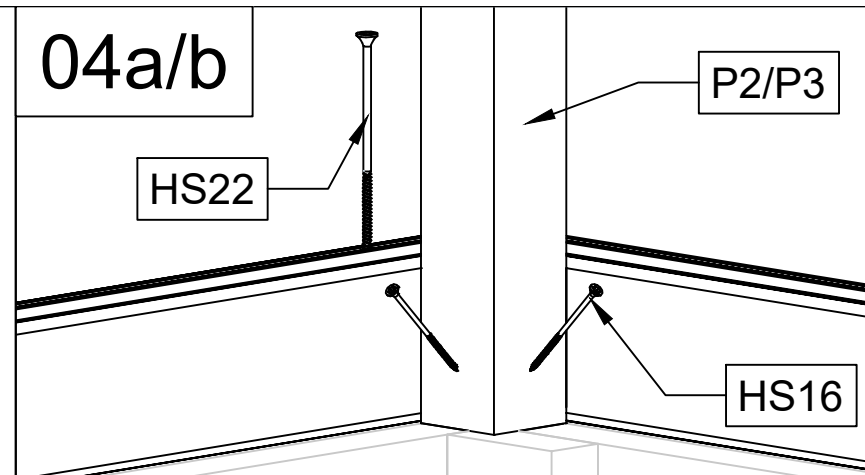
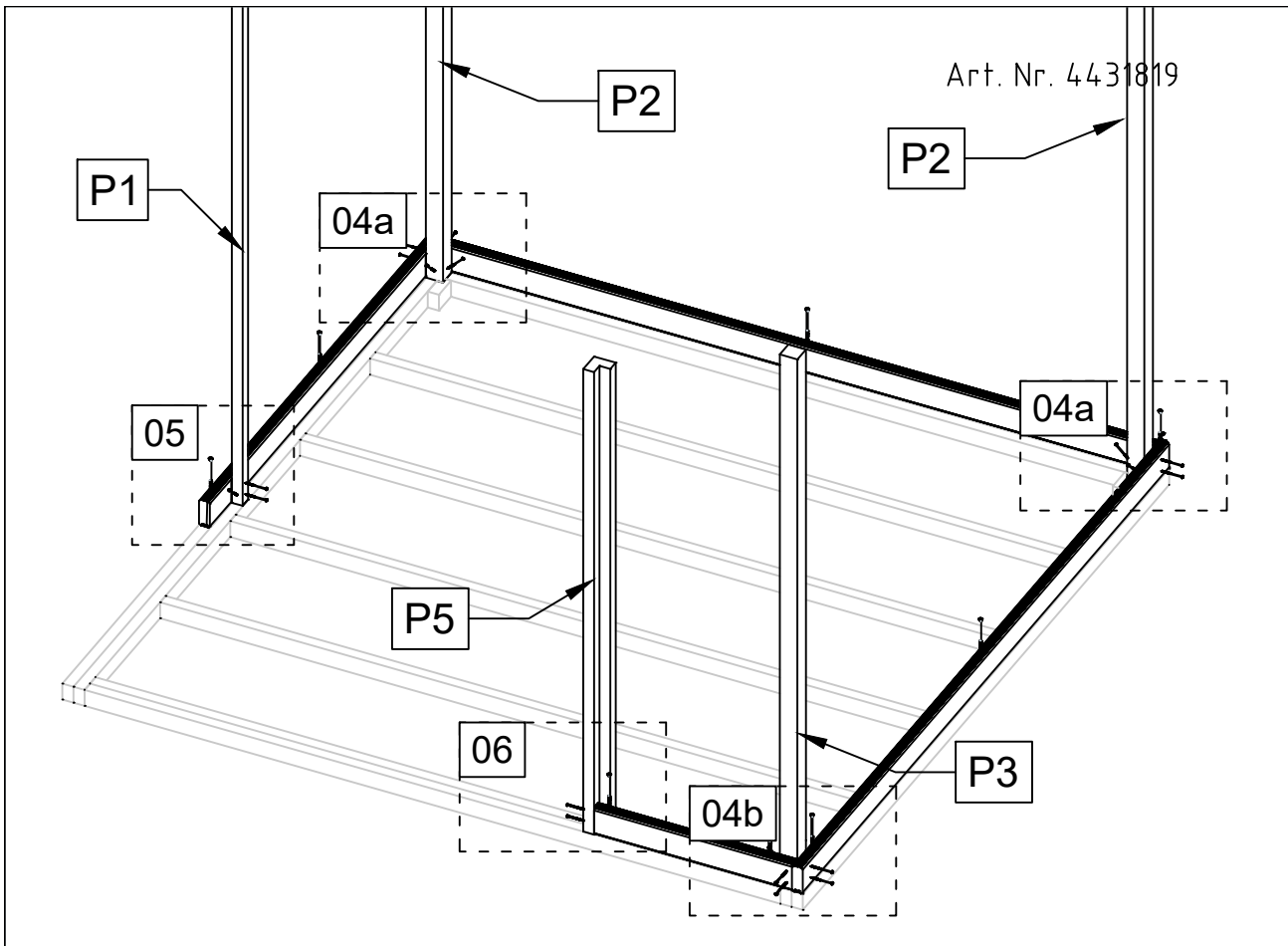

Art. Nr. 4431819

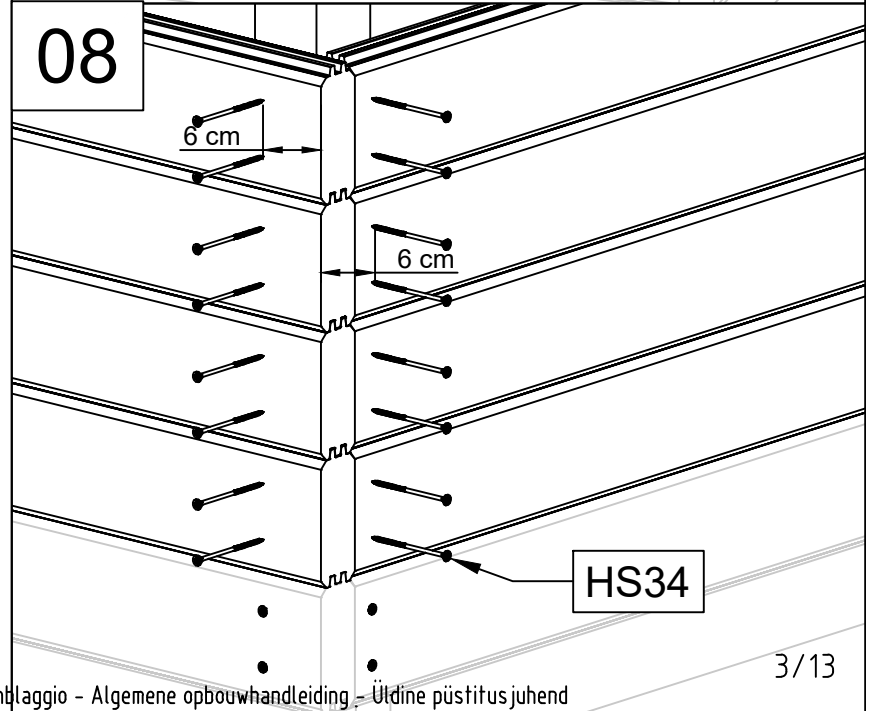
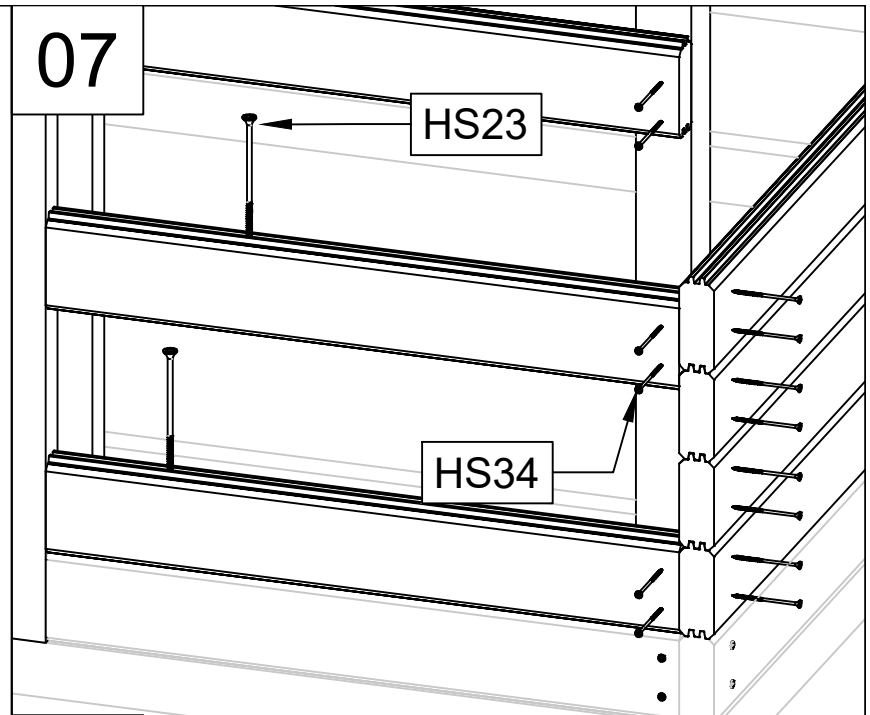
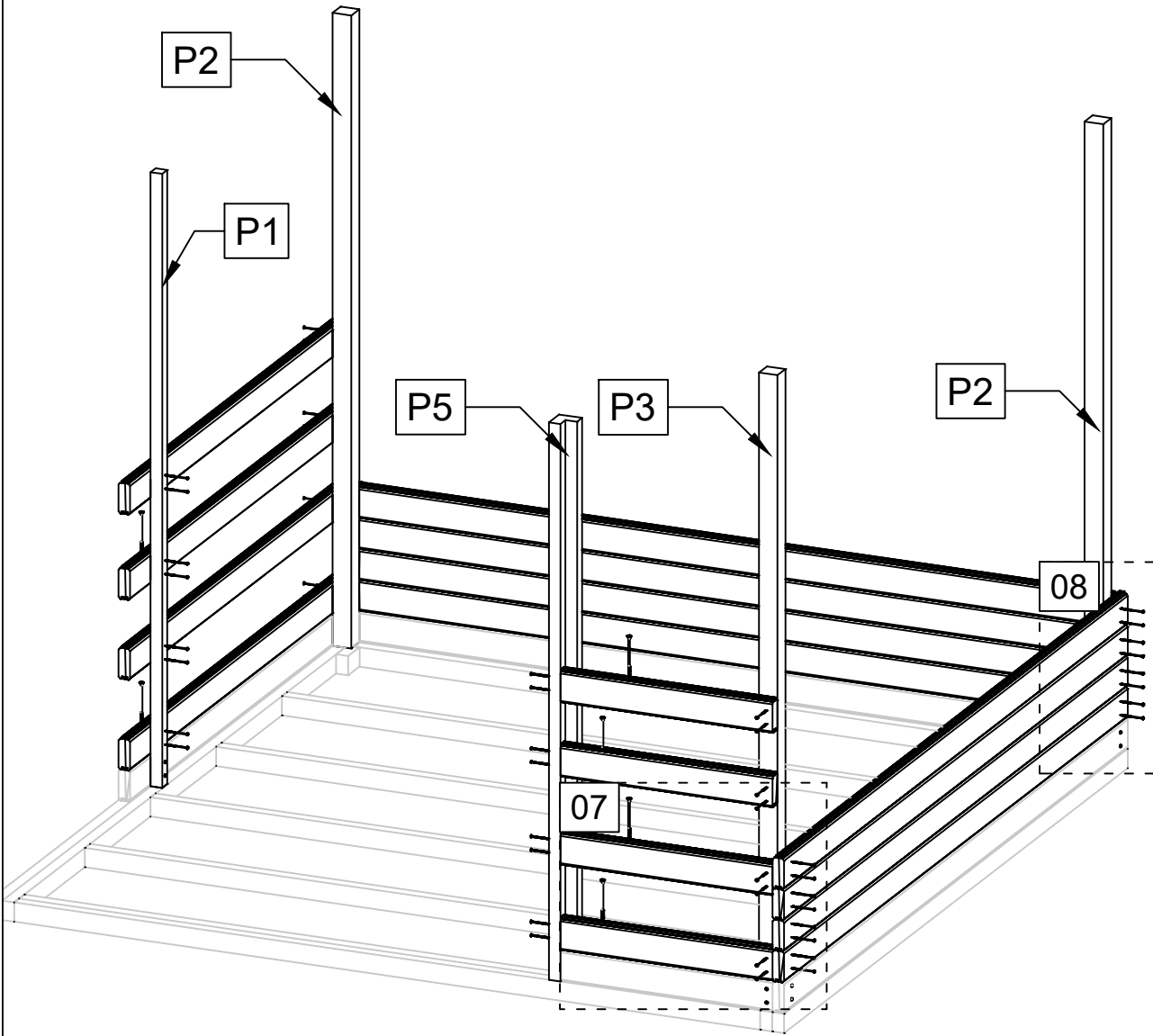

28.08.2023

General installation instructions - Allgemeine aufbauanleitung - Consignes générales de montage - Istruzioni per l'assemblaggio - Algemene opbouwhandleiding - Üldine püstitusjuhend

3/13

Art. Nr. 4431819

09



HS12

FF

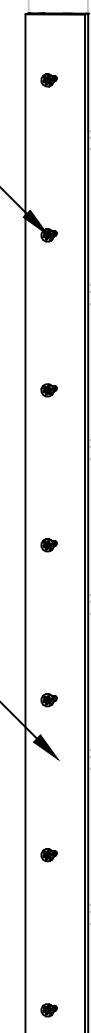

Art. Nr. 4431819

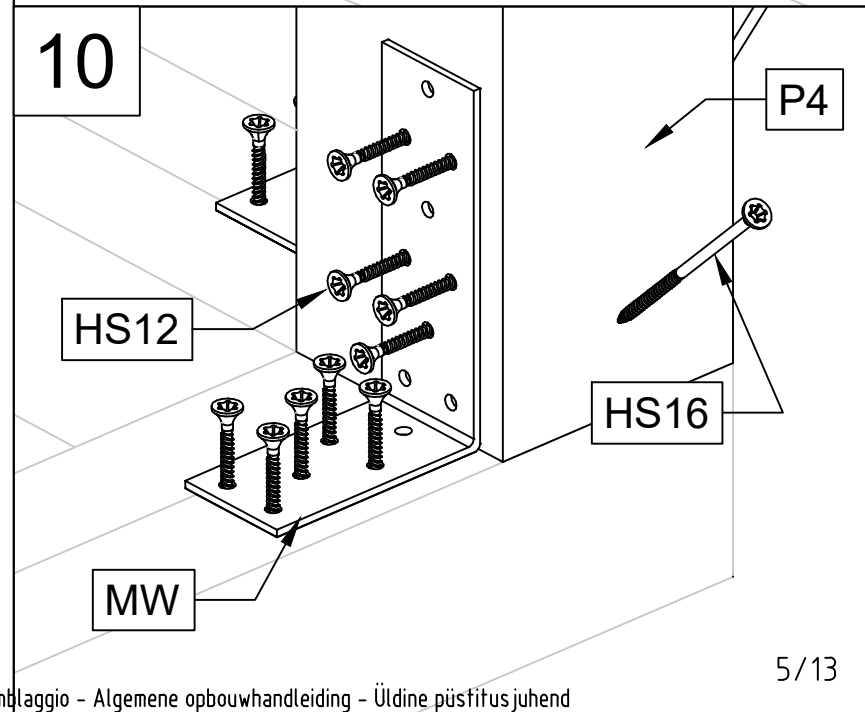
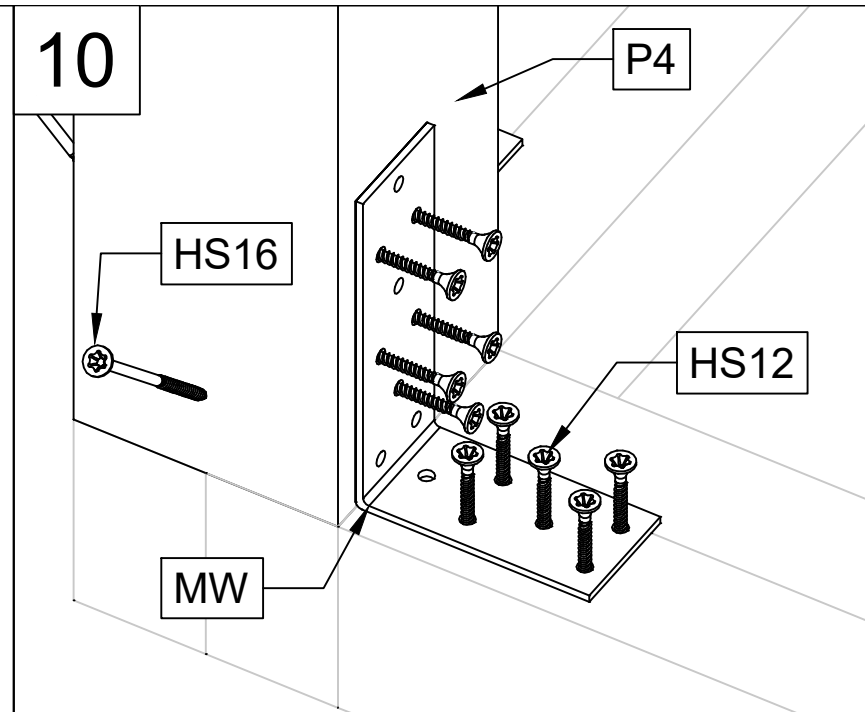
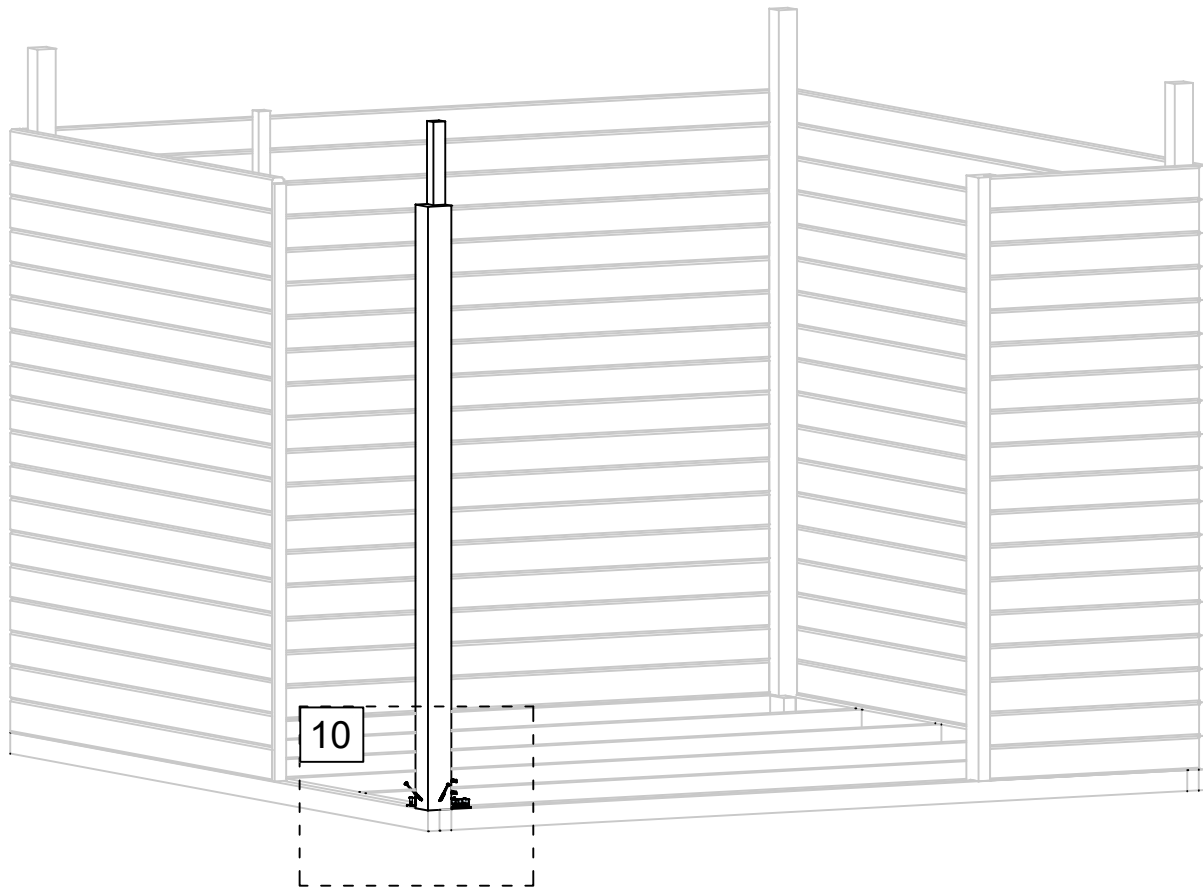

Art. Nr. 4431819

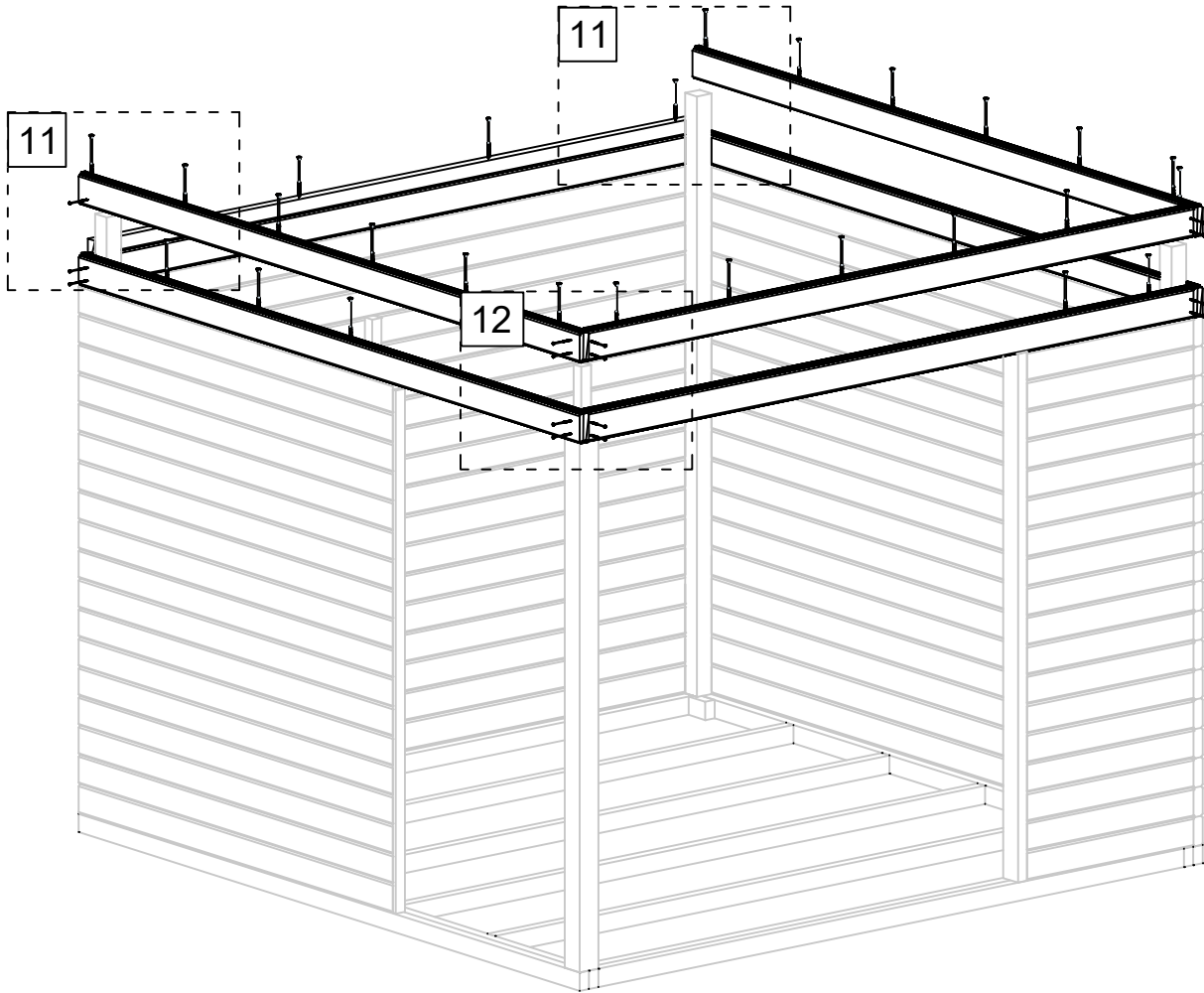

11

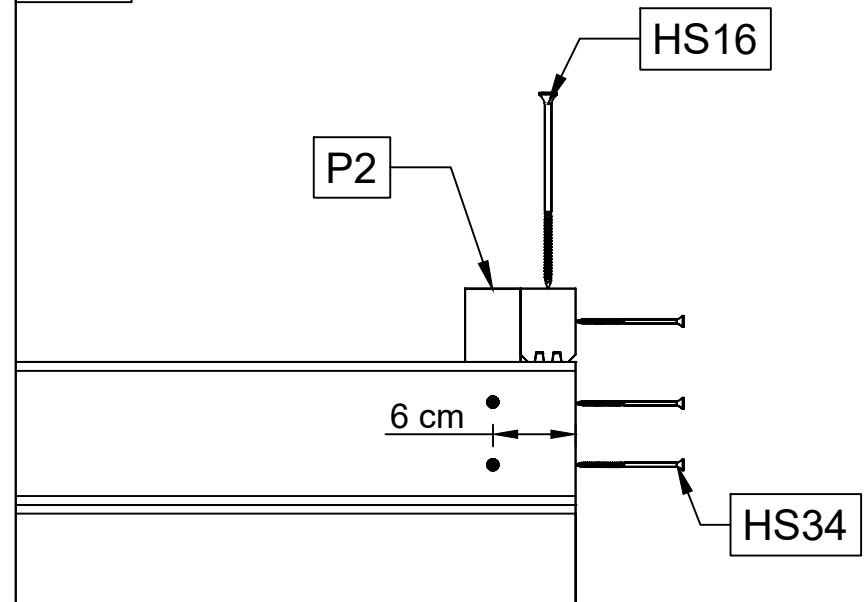

12

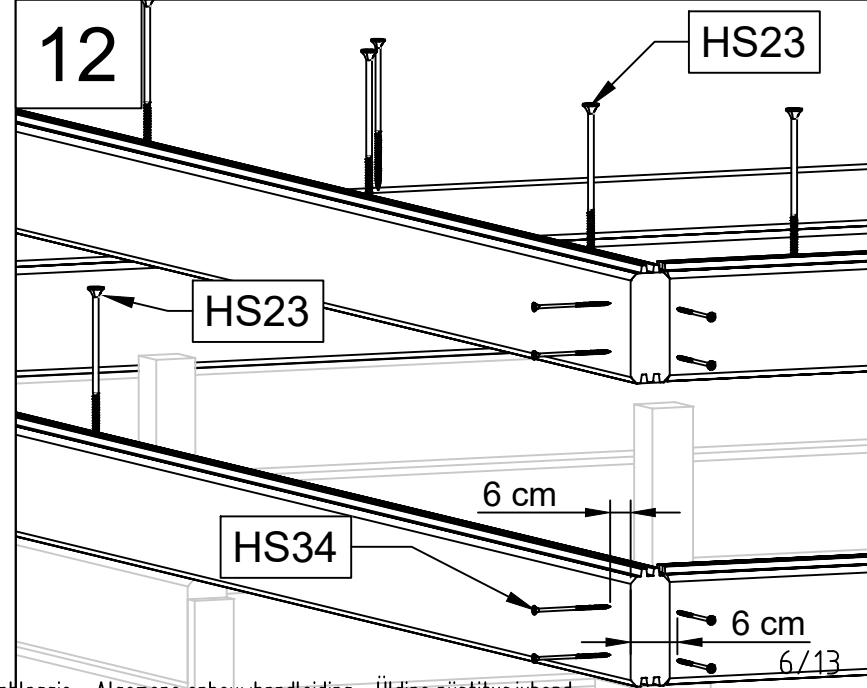

28.08.2023

General installation instructions - Allgemeine aufbauanleitung - Consignes générales de montage - Istruzioni per l'assemblaggio - Algemene opbouwhandleiding - Üldine püstitusjuhend

6/13

Art. Nr. 4431819

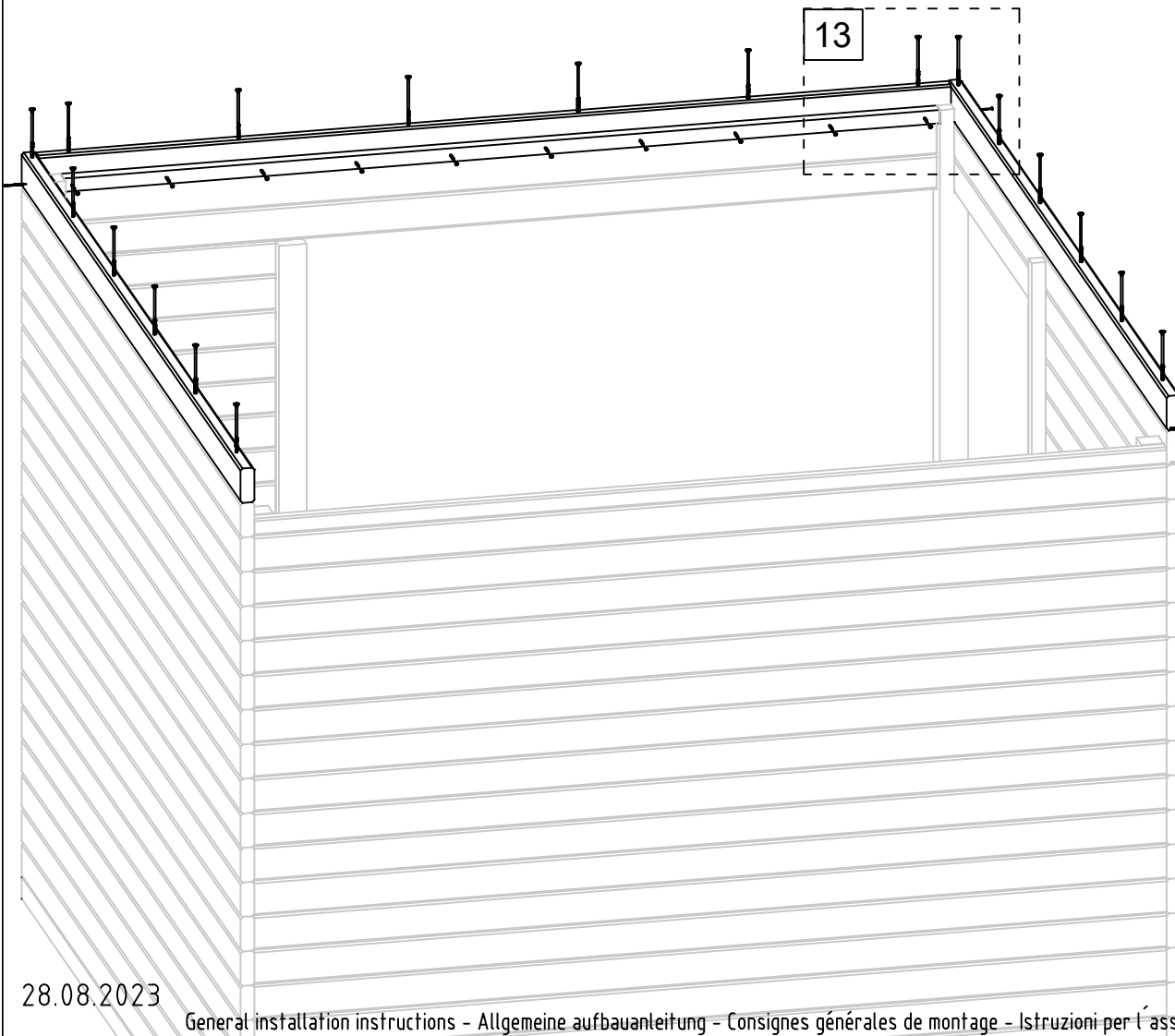

13

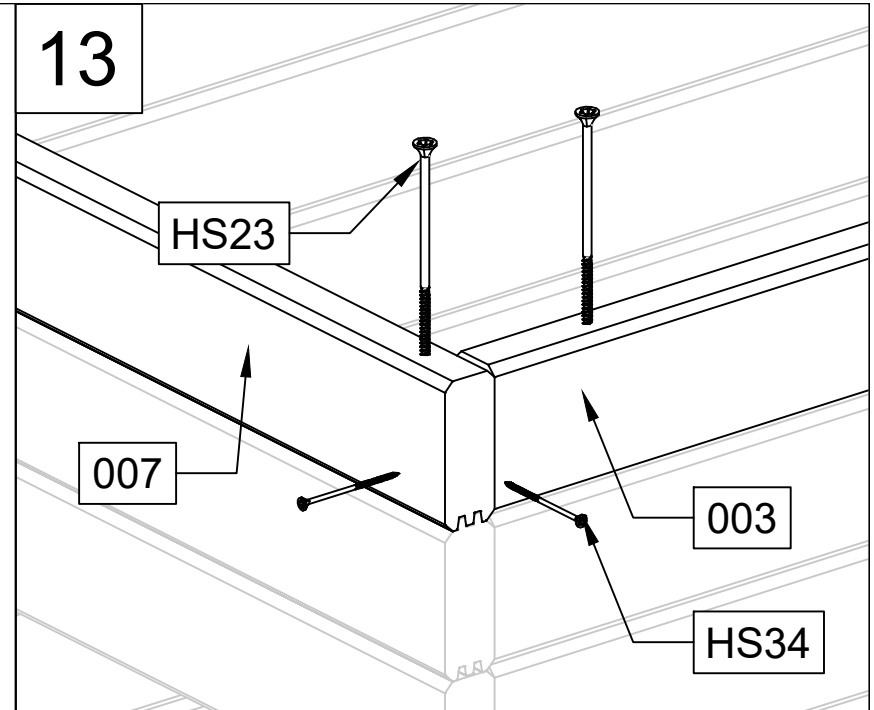

13

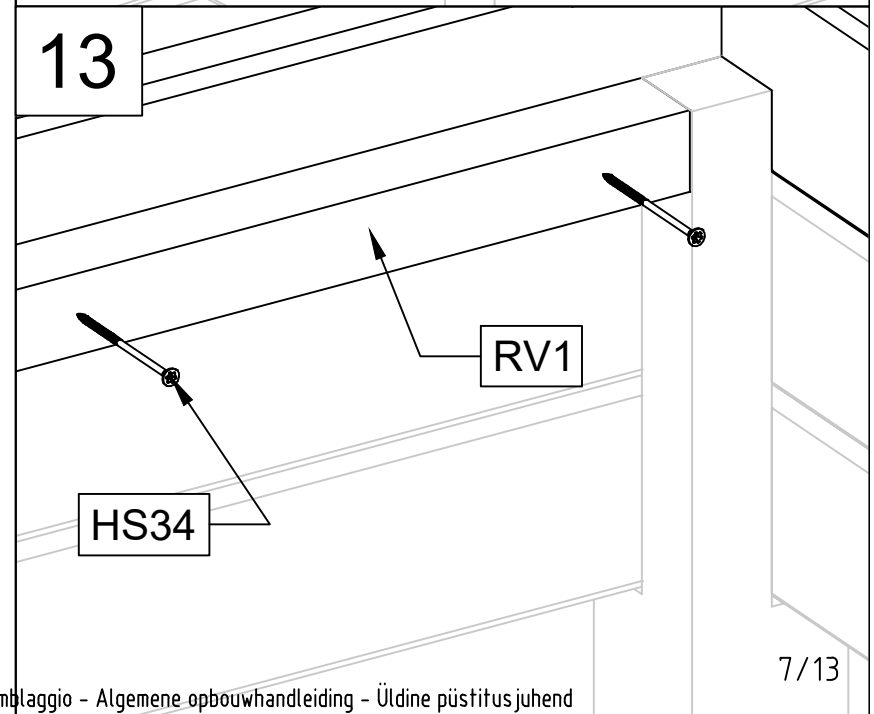

28.08.2023

Art. Nr. 4431819

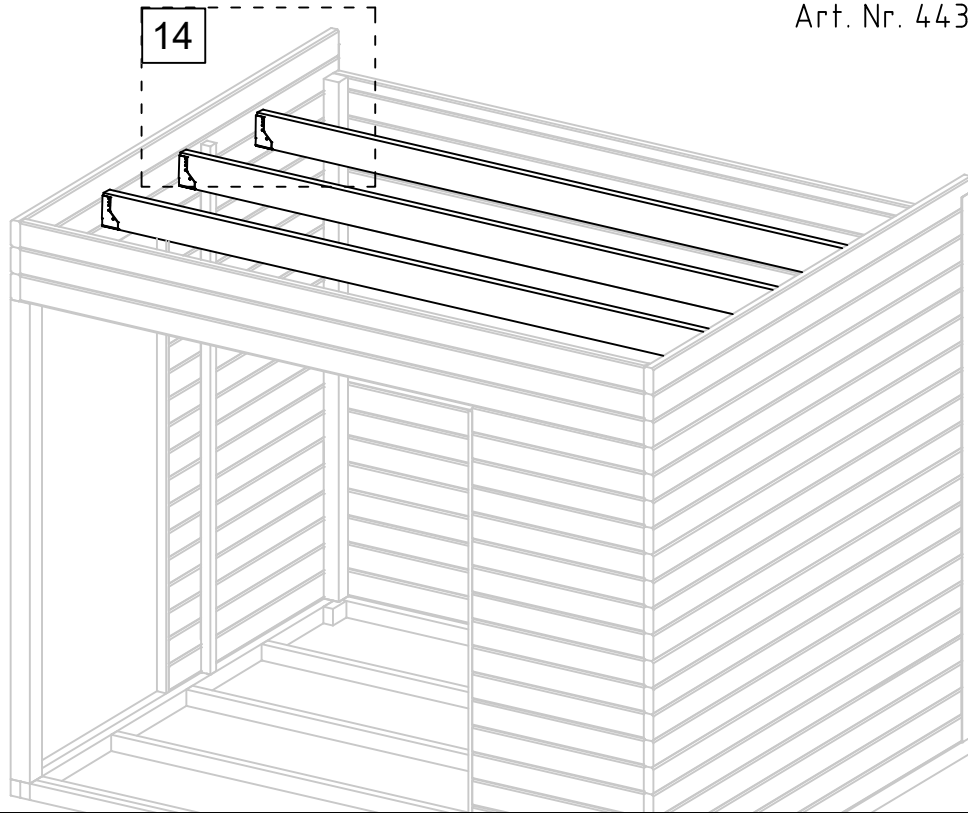

14

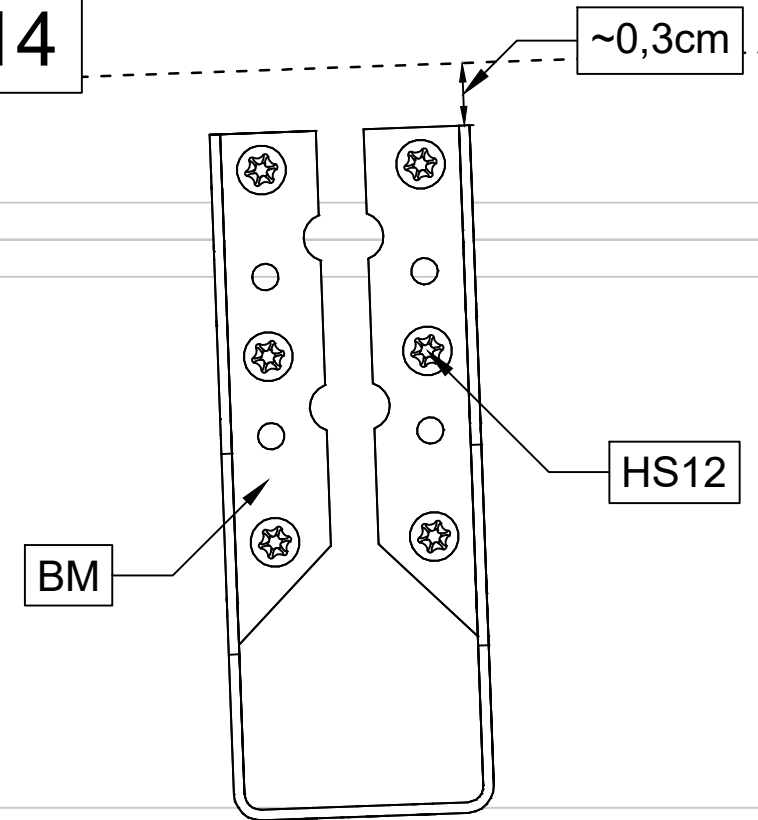

14

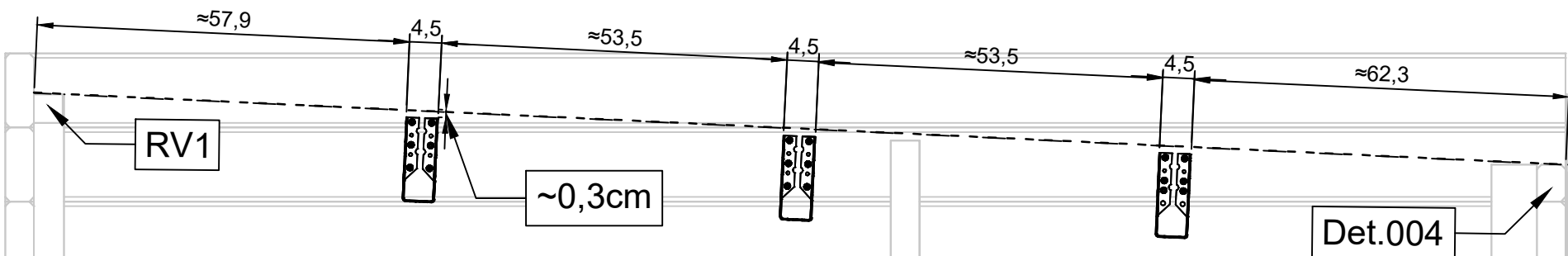

Art. Nr. 4431819

15

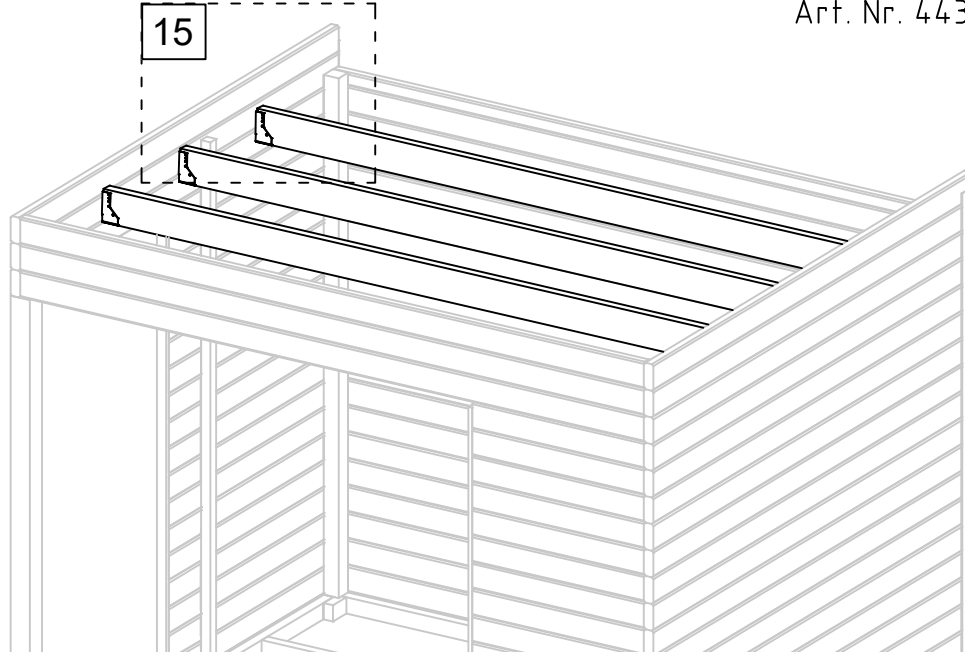

15

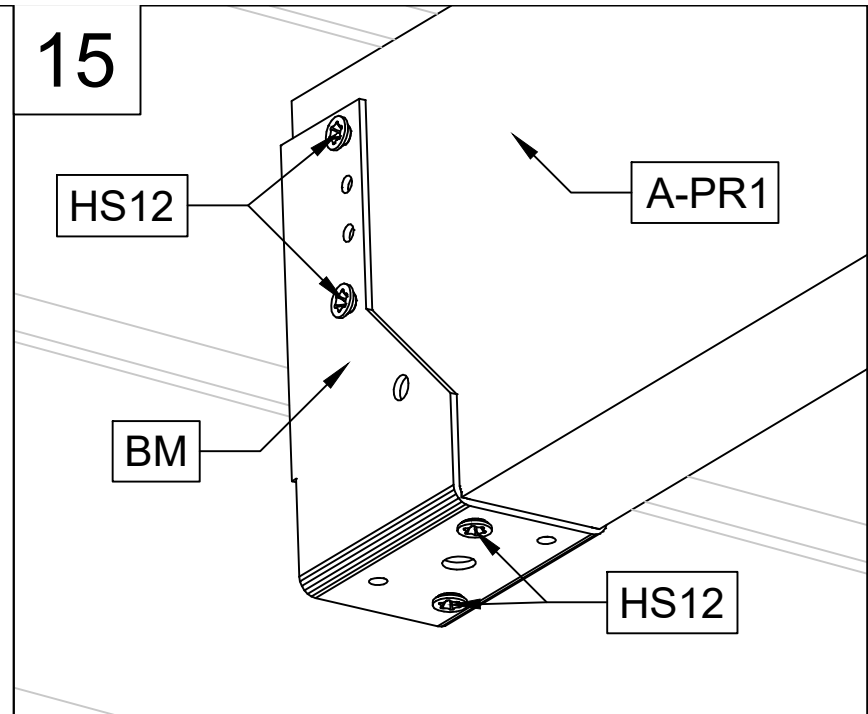

16

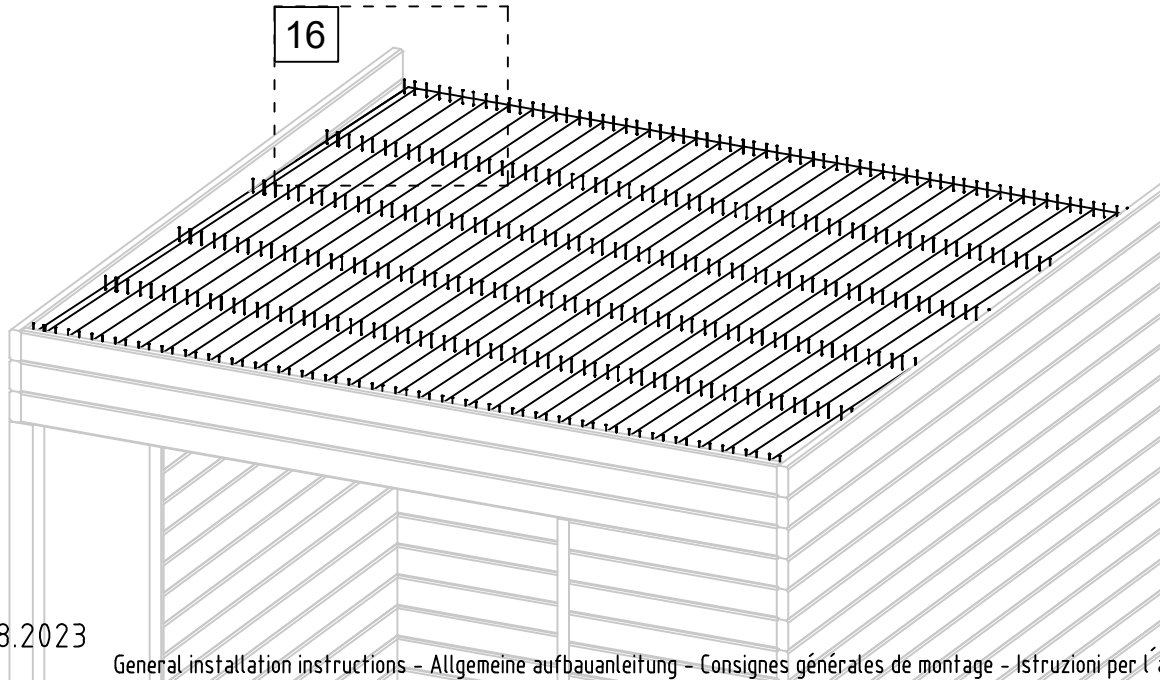

16

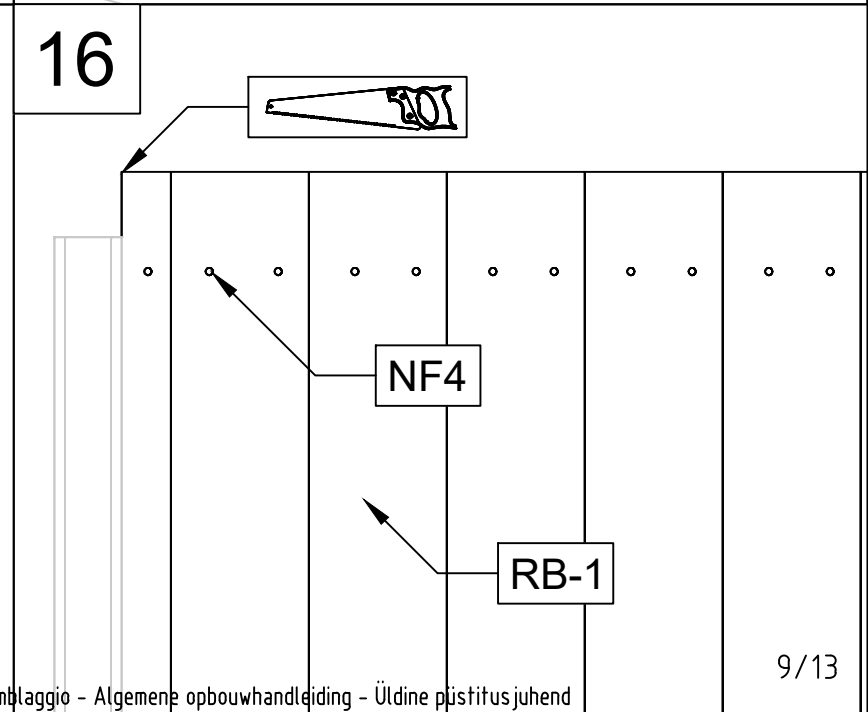

Art. Nr. 4431819

20

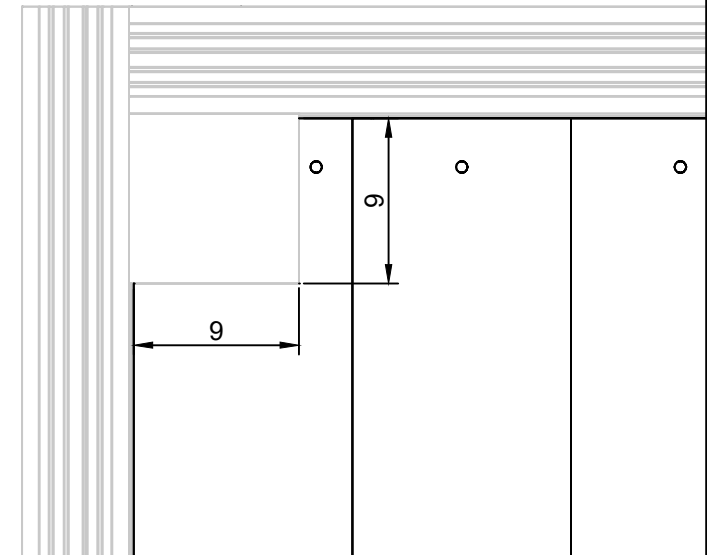
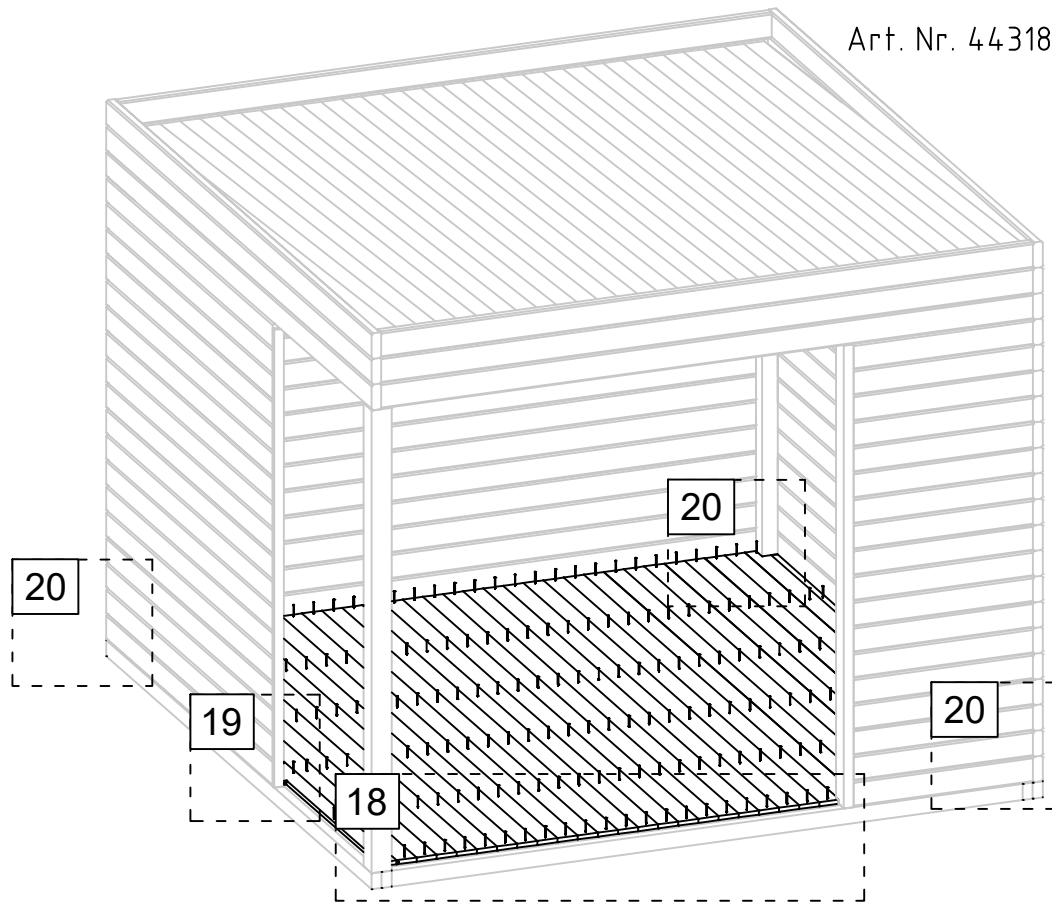

19

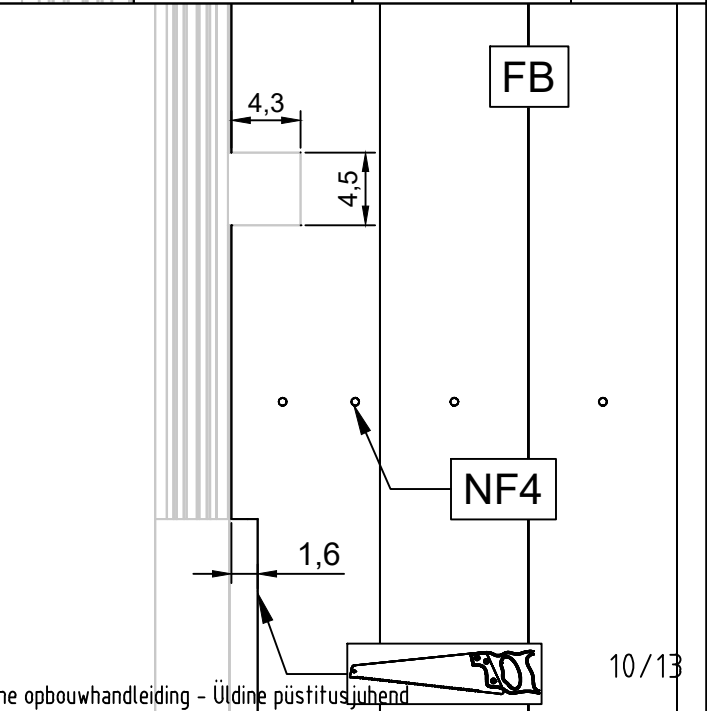

18

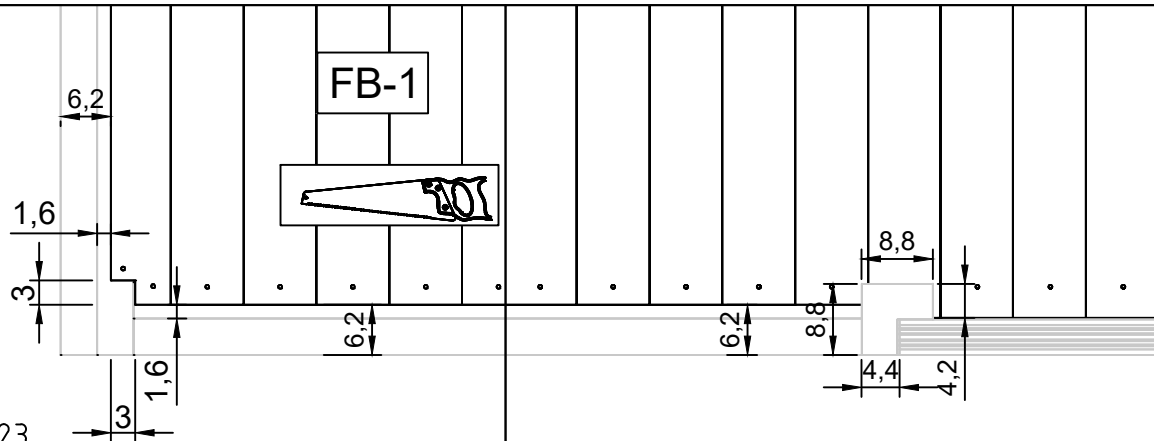

28.08.2023

General installation instructions - Allgemeine aufbauanleitung - Consignes générales de montage - Istruzioni per l'assemblaggio - Algemene opbouwhandleiding - Üldine püstitusjuhend

10/13

Art. Nr. 4431819

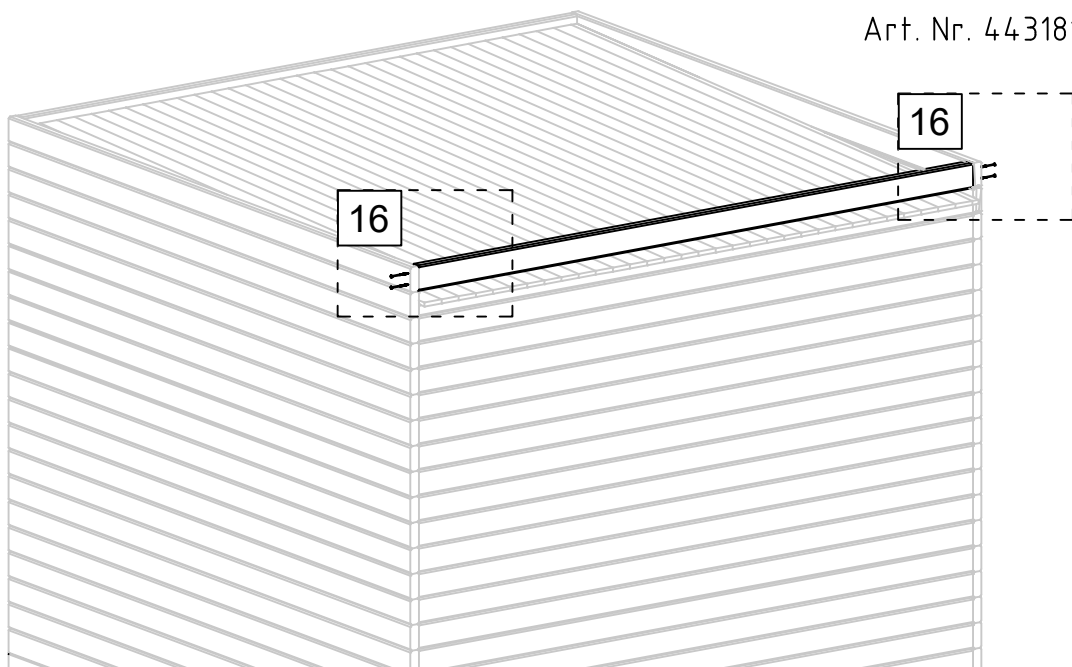

16

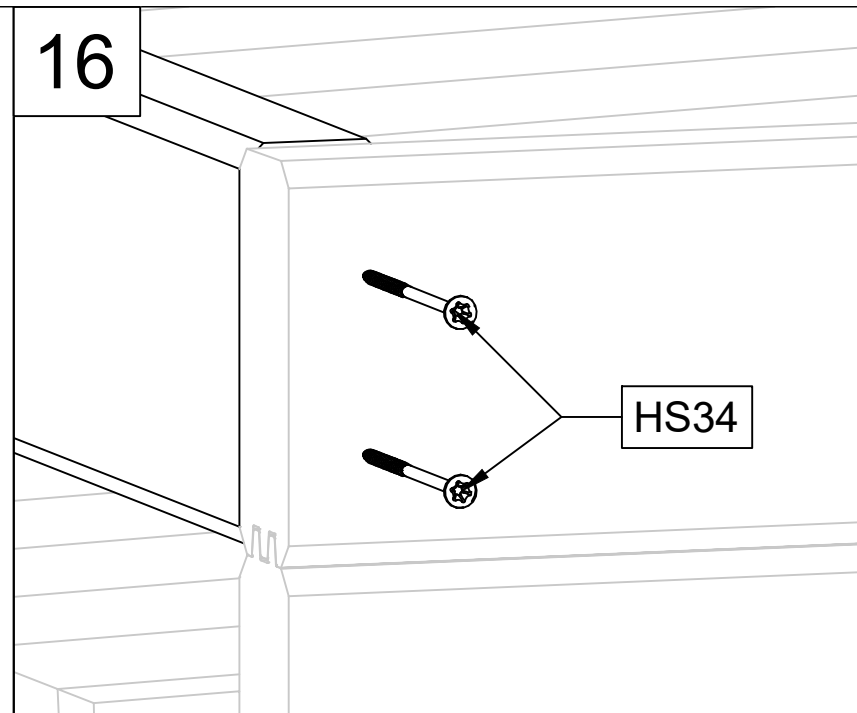

HS34

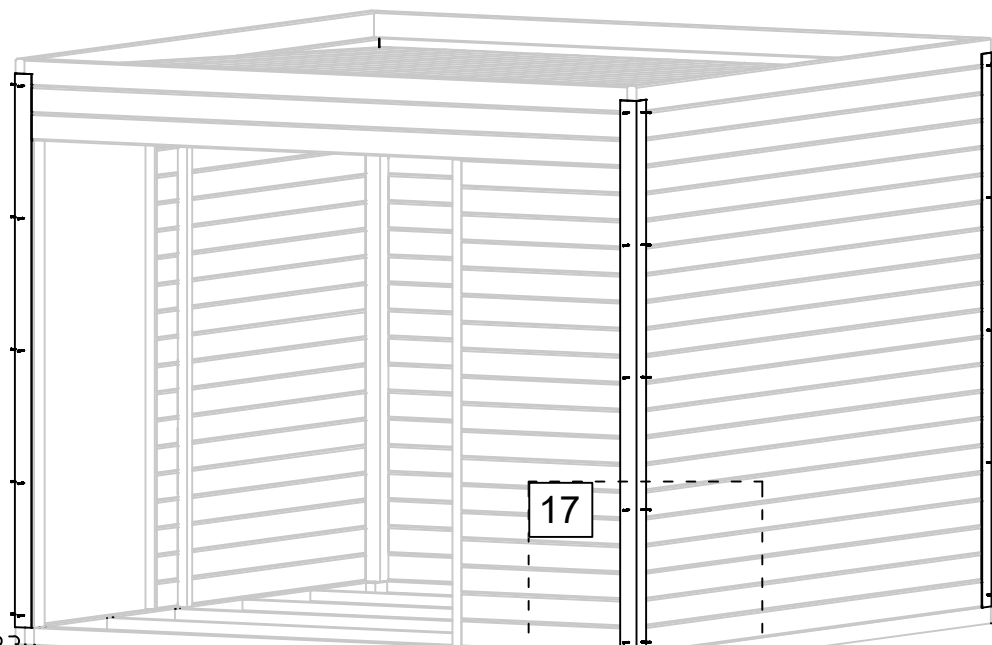

17

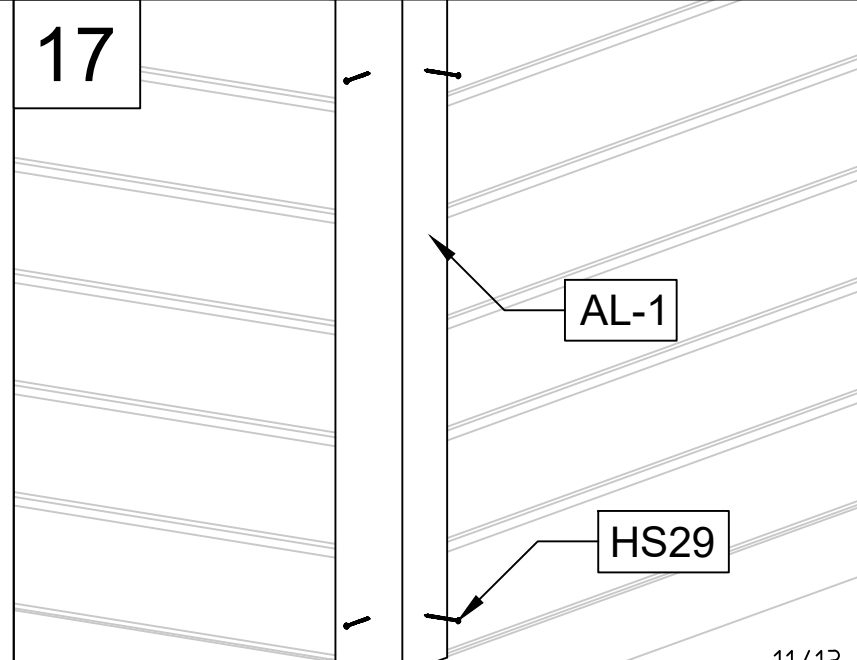

AL-1

HS29

28.08.2023

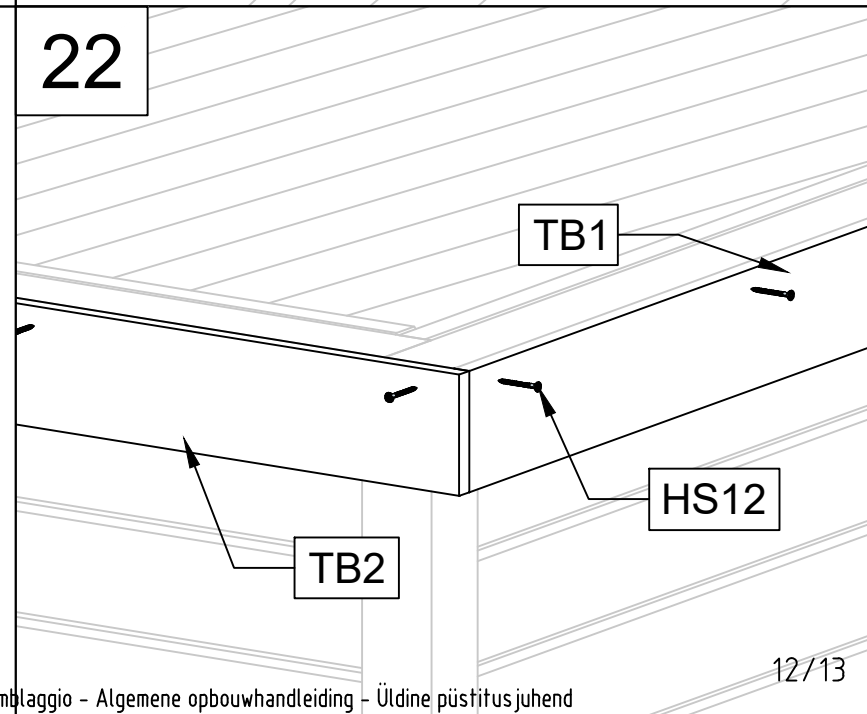
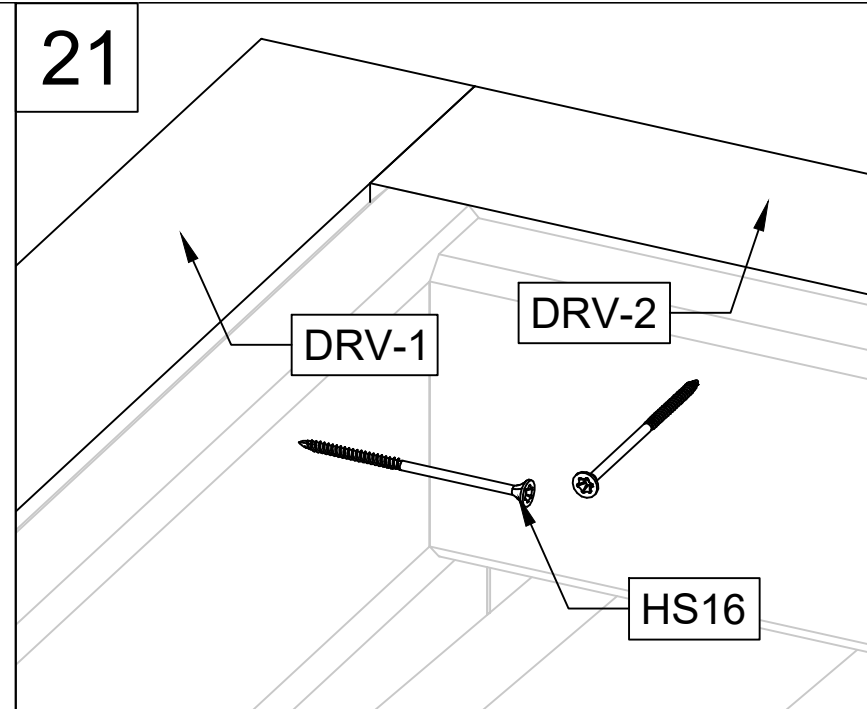
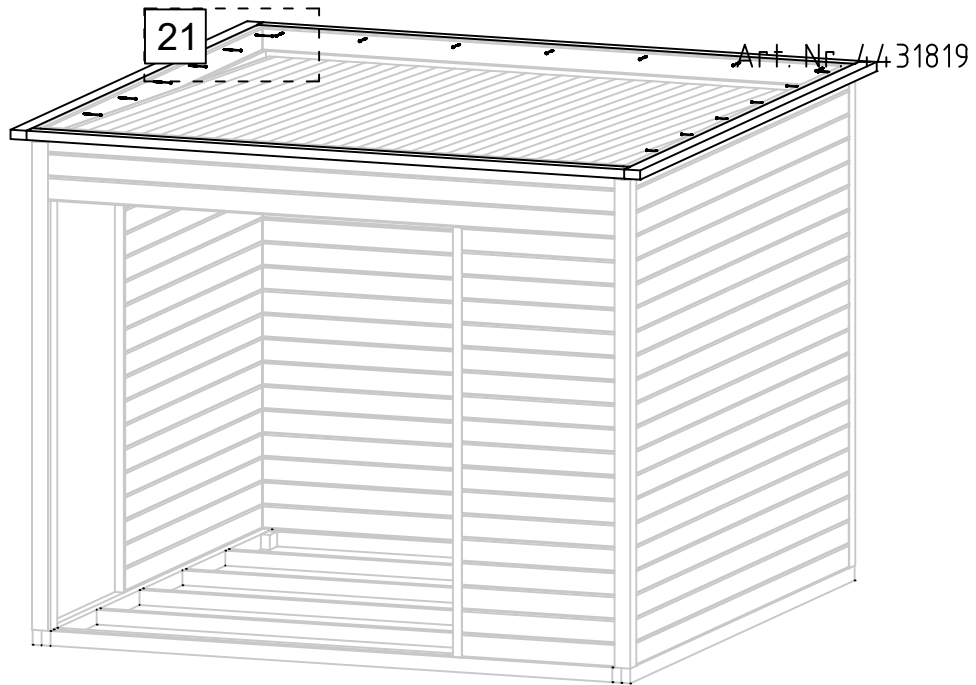

Art. Nr. 4431819

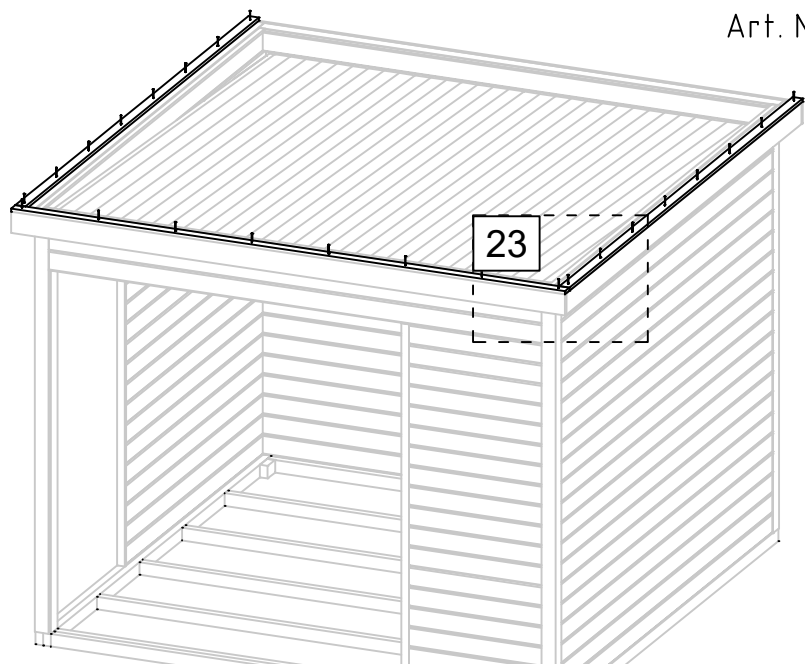

20

