

Charnwood 1
Art. Nr. 4431419
1/8

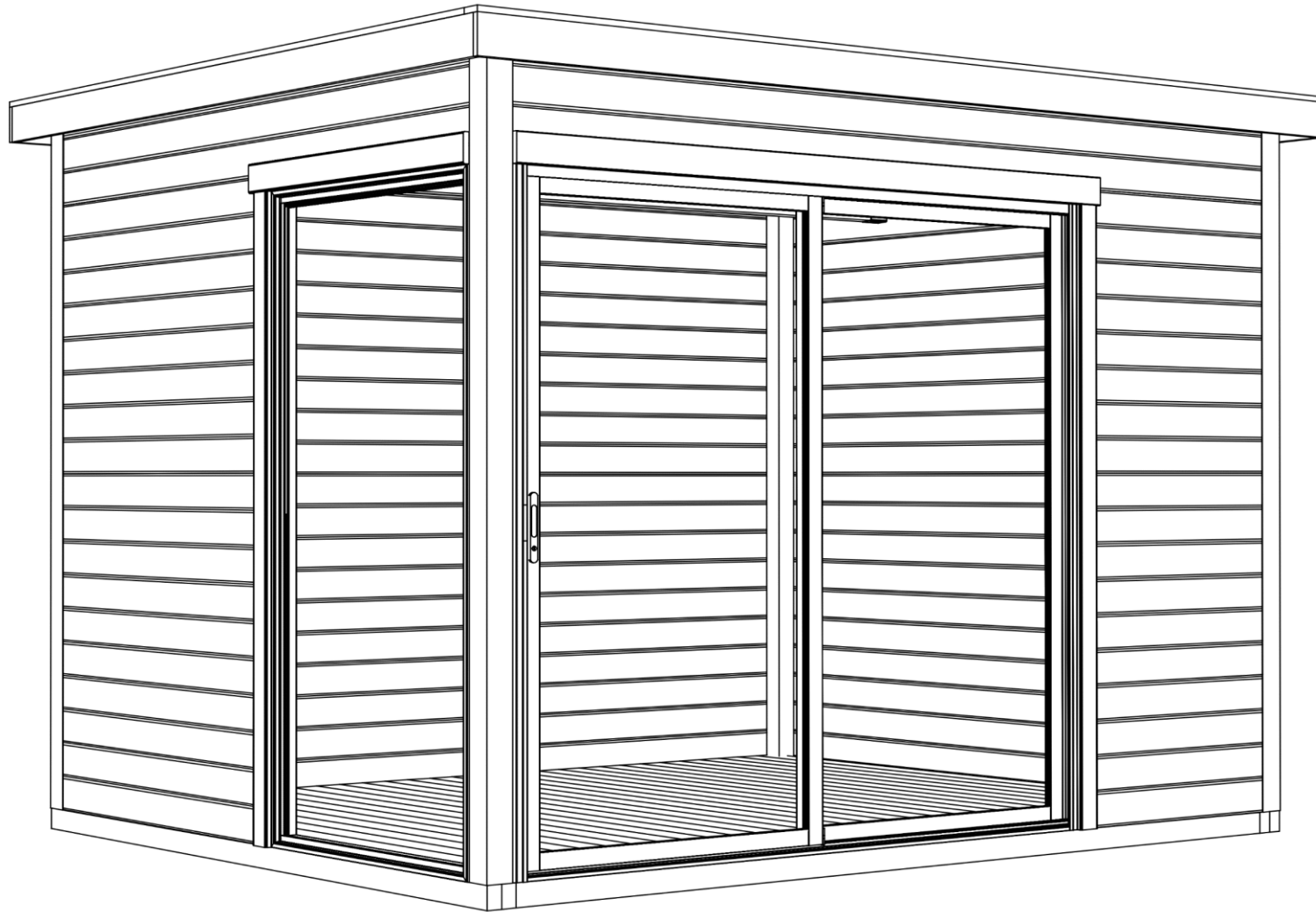

28.07.2023

Art. Nr. 4431419

Groundplan - Grundplan - Plan de masse -
Planimetria - Plattegrond - Põhiplaan

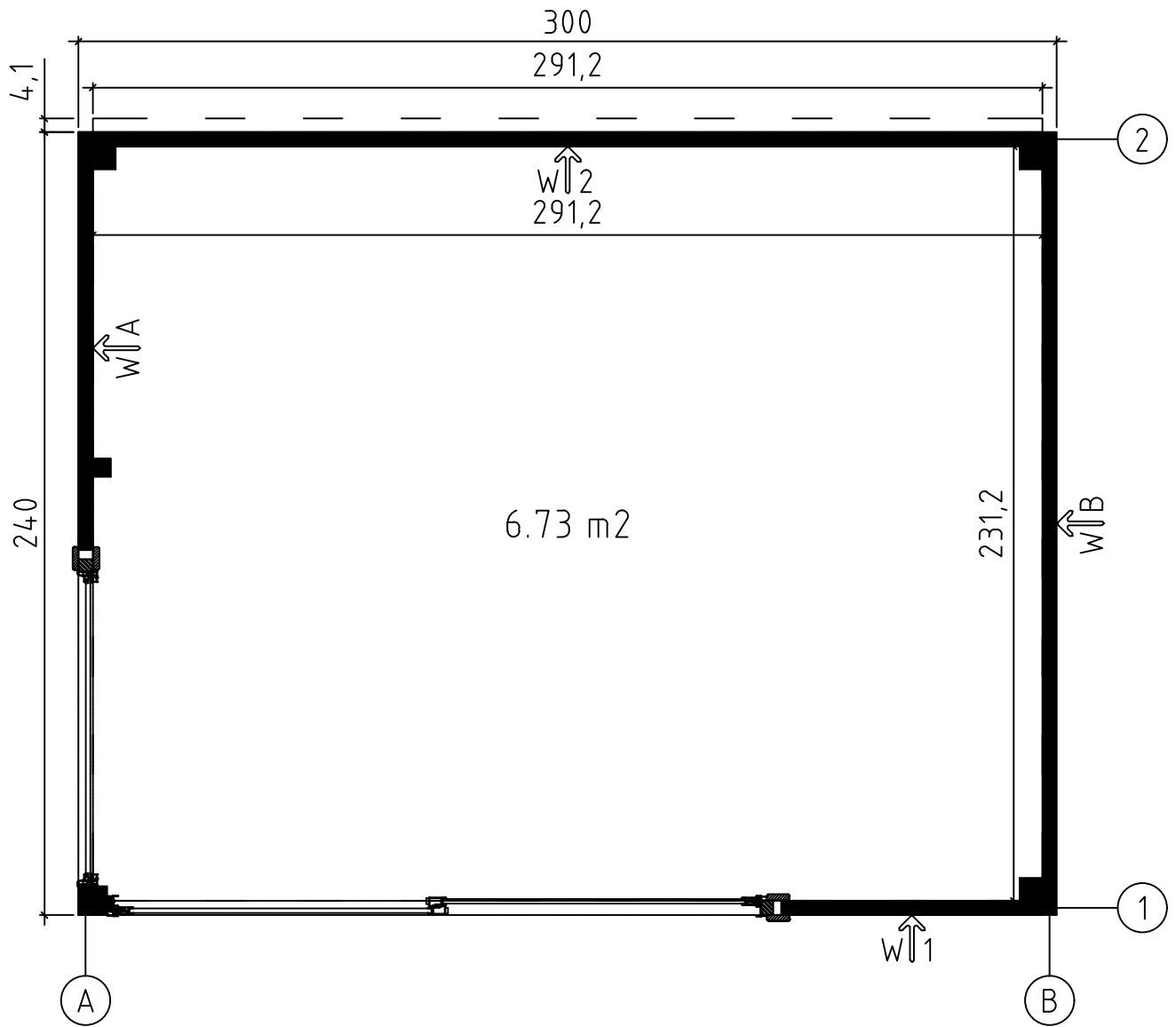

Art. Nr. 4431419

Foundation - Fundament - Fondation -
Fondamenta - Fundering - Immutatud alusraam

Floor boards - Fussbodenbretter - Plan pose plancher -
Pavimento - Vloerhout - Põrandalaudis

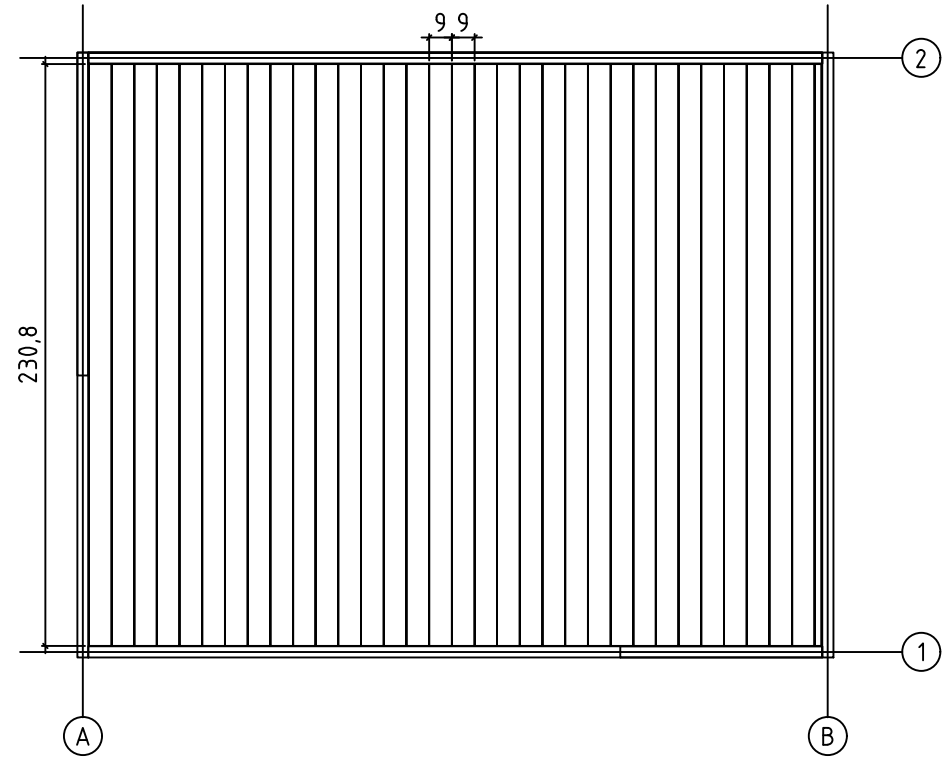
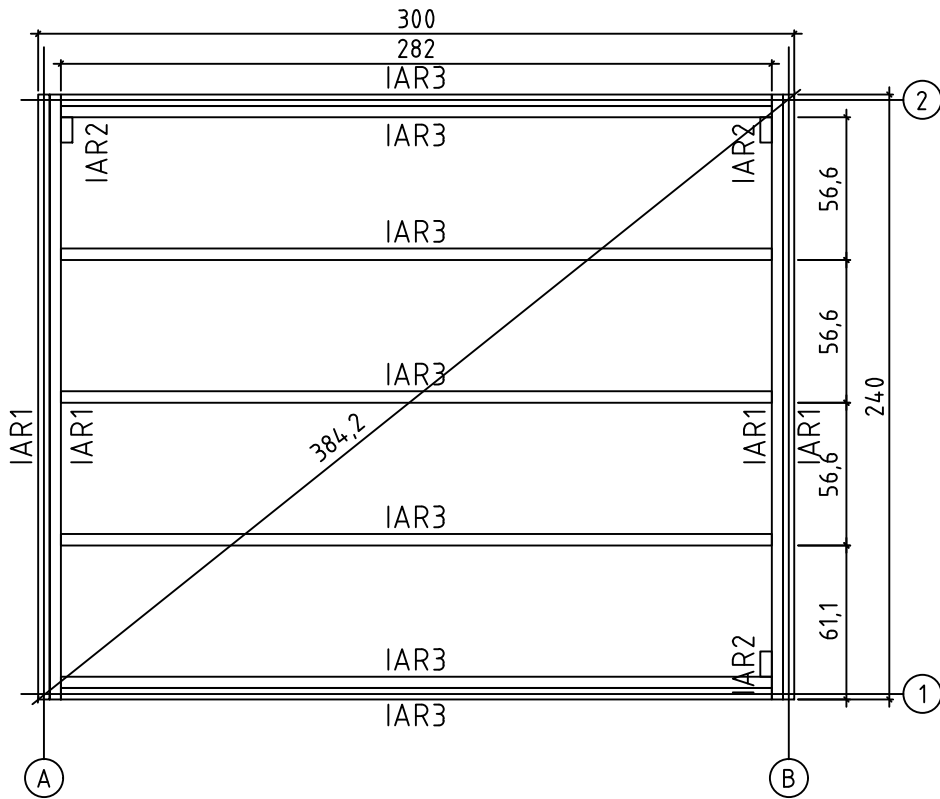



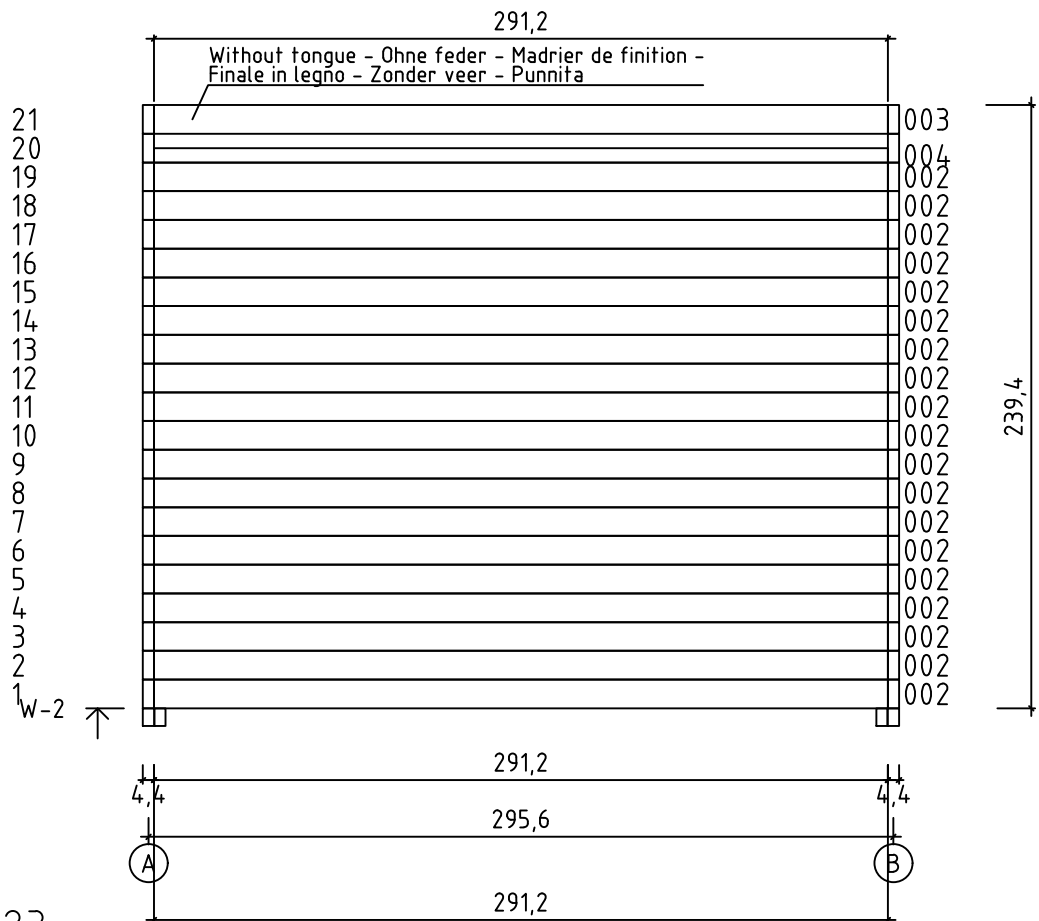
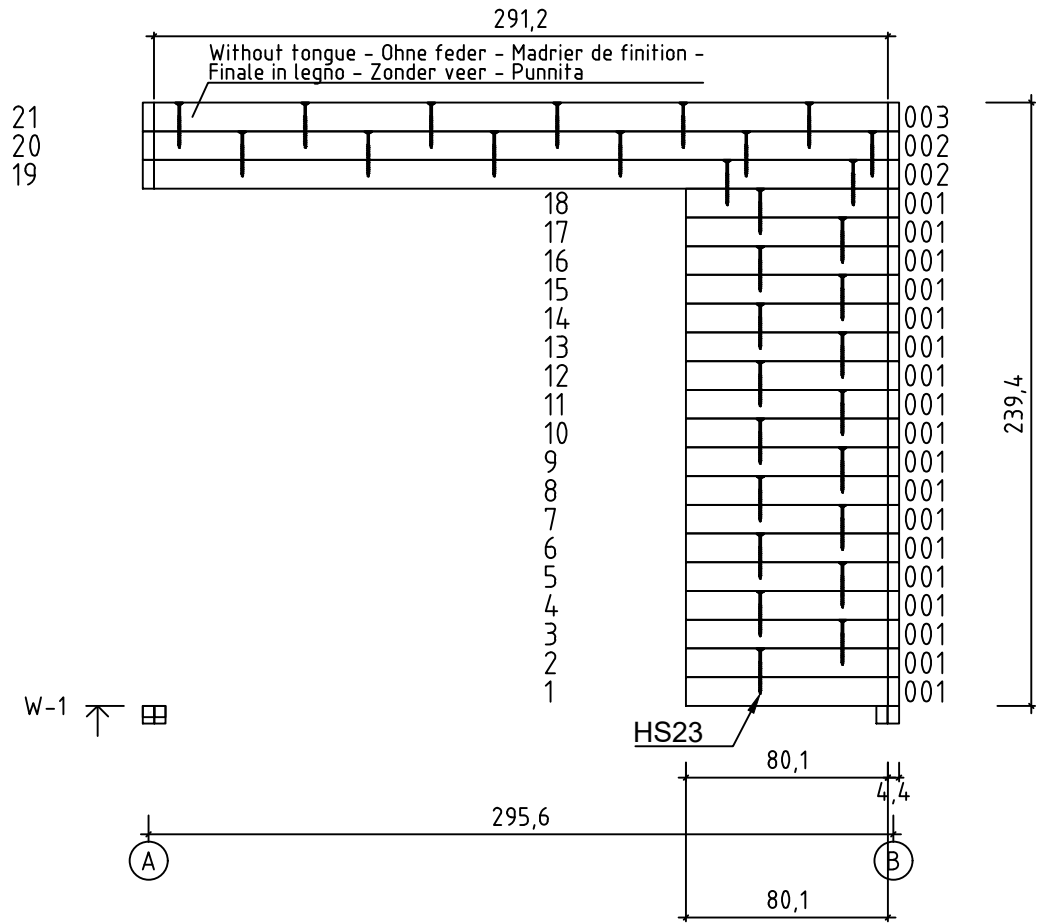



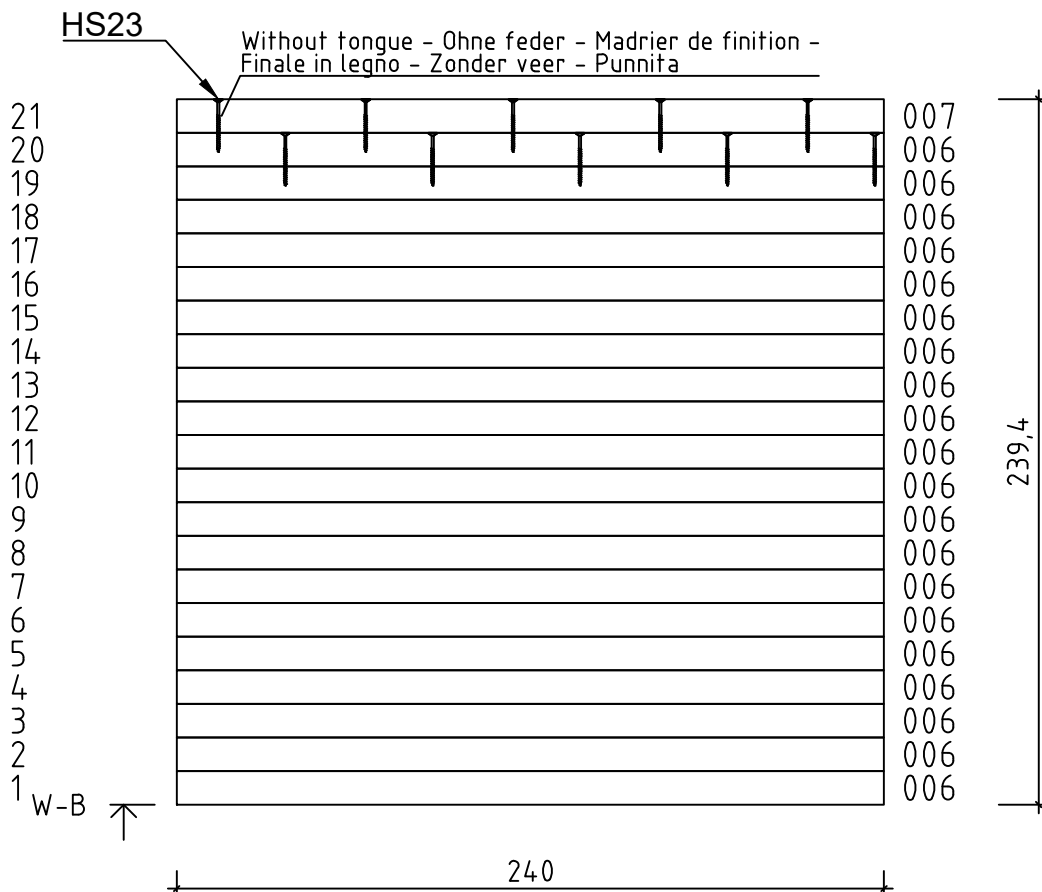
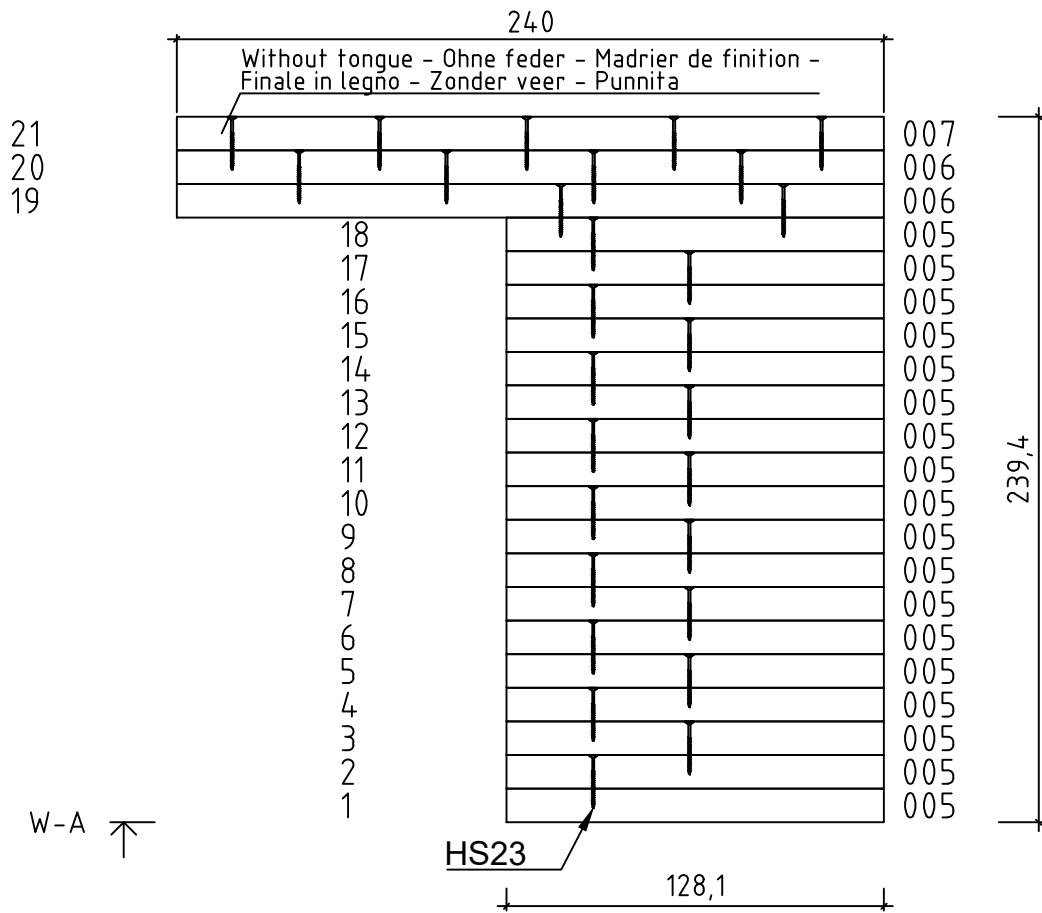

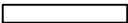

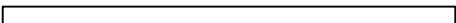
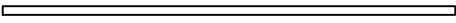

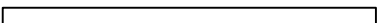

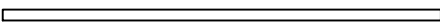
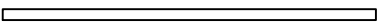



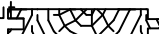



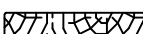
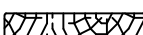
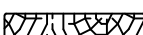
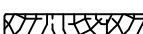
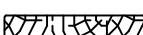
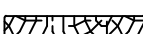

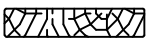
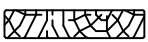
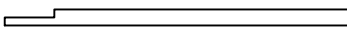

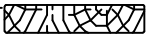
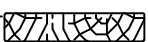





Art. Nr. 4431419







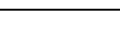

Art. Nr. 4431419

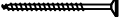
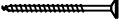
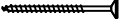
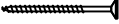
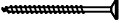
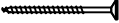
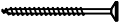
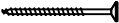
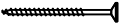
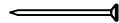

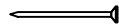
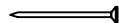
Pos	28.07.2023 Piece list - Stückliste - Liste des pièces - Elementi - Stuklijst - Tükitalabel Art. Nr. 4431419 6/8	Q	P (mm)	L (mm)
001 37781		18	44x114	801
002 21421		21	44x114	2912
003 23883		2	44x114	2912
004 35705		1	44x57	2912
005 45767		18	44x114	1281
006 46519		22	44x114	2400
007 46520		2	44x114	2400
IAR3 28458	Foundation - Fundament - Fondation - Fondamenta - Fundering - Immutatud alusraam 	7	45x70	2820
IAR1 29275	Foundation - Fundament - Fondation - Fondamenta - Fundering - Immutatud alusraam 	4	45x70	2400
IAR2 34041	Foundation - Fundament - Fondation - Fondamenta - Fundering - Immutatud alusraam 	3	45x70	100
RV1 39449	Lath - Pfetten - Liteau - Piccola asse - Gordingen - Roov 	1	44x44	2796
A-PR1 37783	Roof beam - Dachbalken - Panne de toit - Perlina del tetto - Gordingen / dakbalk - Pärilin 	3	44x140	2904
FB 23132	Floor boards - Fussbodenbretter - Lame de plancher - Pavimento - Vloerhout - Põrandalaud 	33	90x18	2308
RB 3014	Roof boards - Dachbretter - Voliges - Perlina per tetto - Dakhout - Katuselaud 	33	90x18	2400
FL-1 30087	Floor fillet - Fussbodenleiste - Corniere de finition du plancher - Finitura per pavimento (battisco pa) - Vloerafwerklijst - Põrandaliist 		18x18	11
DPL2 46523	Roofing felt fillet - Dachpappenleiste - Baguette de fixation du feutre bitumeux - Asse per fissaggio guaina bituminosa - Afdekljst asfaltpapier - Katusepapiiist 	2	18x58	2538
DPL1 37785	Roofing felt fillet - Dachpappenleiste - Baguette de fixation du feutre bitumeux - Asse per fissaggio guaina bituminosa - Afdekljst asfaltpapier - Katusepapiiist 	1	18x58	3196
RS1 37808	Railing strip - Begrenzungsleiste - Rembarde - Sbarra - Afscheidingslijst - Piirdelaud 	1	18x70	1975
RS2 37809	Railing strip - Begrenzungsleiste - Rembarde - Sbarra - Afscheidingslijst - Piirdelaud 	1	18x70	1982
RS3 37810	Railing strip - Begrenzungsleiste - Rembarde - Sbarra - Afscheidingslijst - Piirdelaud 	1	18x70	1993
RS4 35597	Railing strip - Begrenzungsleiste - Rembarde - Sbarra - Afscheidingslijst - Piirdelaud 	1	18x70	2000
RS5 37811	Railing strip - Begrenzungsleiste - Rembarde - Sbarra - Afscheidingslijst - Piirdelaud 	1	18x90	1065
RS6 37812	Railing strip - Begrenzungsleiste - Rembarde - Sbarra - Afscheidingslijst - Piirdelaud 	1	18x90	1075

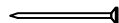
Pos	28.07.2023 Piece list - Stückliste - Liste des pièces - Elementi - Stuklijst - Tükítabel Art. Nr. 4431419 7/8	Q	P (mm)	L (mm)
RS7 37813	Railing strip - Begrenzungsleiste - Rembarde - Sbarra - Afscheidingslijst - Piirdelaud 	1	18x90	2116
RS8 37814	Railing strip - Begrenzungsleiste - Rembarde - Sbarra - Afscheidingslijst - Piirdelaud 	1	18x90	2126
P	Post - Pfosten - Poteau - Piede registrabile - Stijl - Post 	1	88x88	2330
P1 31654	Post - Pfosten - Poteau - Piede registrabile - Stijl - Post 	1	44x44	2260
P2 39450	Post - Pfosten - Poteau - Piede registrabile - Stijl - Post 	3	70x70	2330
TB2 46521	Fascia board - Traufbrett - Bandeau de toit - Finitura lati tetto - Gevellijst - Räästalaud 	2	18x120	2560
TB1 35709	Fascia board - Traufbrett - Bandeau de toit - Finitura lati tetto - Gevellijst - Räästalaud 	2	18x120	3196
DRV-2 46522	Roof edge reinforcement - Dachrandverstärkung - Corniere de renfort de bord de toit - Rinforzo x tetto - Dakrand versterking - Räästatugevdus 	2	80x44	2560
DRV-1 35712	Roof edge reinforcement - Dachrandverstärkung - Corniere de renfort de bord de toit - Rinforzo x tetto - Dakrand versterking - Räästatugevdus 	2	80x44	3000
FF2 28448	Fixing fillet - Fixierungsleiste - Profil de fixation - Massello di fissaggio - Bevestiging lijstwerk - Tenderliist 	1	15x45	2026
FF 23905	Fixing fillet - Fixierungsleiste - Profil de fixation - Massello di fissaggio - Bevestiging lijstwerk - Tenderliist 	2	18x44	2030
FF3 37815	Fixing fillet - Fixierungsleiste - Profil de fixation - Massello di fissaggio - Bevestiging lijstwerk - Tenderliist 	1	38x46	1980
FF4 37816	Fixing fillet - Fixierungsleiste - Profil de fixation - Massello di fissaggio - Bevestiging lijstwerk - Tenderliist 	2	38x46	2026
HS32 5107	Screw for door jamb - Schraube für türrahmen - Vis de fixation partie haute avec montants du cadre de porte - Viti x fissaggio montanti porte - Schroef voor deurkozijn - Kruvi ukse lengile 	2	4.5x25	
HS14 40958	Screw for wall details - Schraube für wand details - Vis pour mur details - Viti per elementi della porta - Schroef voor wand details - Kruvi seinte montaažiks 	310	5x80	
HS12 5109	Screw for doorstep - Schrauben für swelle - Vis pour fixation barre de seuil - Vite per soglia della porta - Schroef voor deurdorpel - Kruvi lävepakule 	3	4x40	
HS12 5109	Screw for metal corner - Holzschraube für metallwinkel - Vis de fixation des cornieres en métal - Viti per fissare suadretta di metallo di giunzione - Schroef voor metalen hoek - Kruvi nurgikule 	20	4x40	
HS12 5109	Screw for covering moulding - Schrauben für deckungsprofil - Vis de fixation profils horizontaux haut inférieur et extérieur d'encadrement de porte - Vite per cornice di copertura - Schroef voor afdekprofiel - Kruvi piirdelauale 	30	4x40	
HS12 5109	Screw for fascia boards - Schrauben für traufbretter - Vis pour fixation bandeau de toit - Viti x striscia del tetto - Schroef voor gevellijst - Kruvi räästalauale 	32	4x40	
HS12 5109	Screw for beam holder - Schrauben für balkenhalter - Vis de fixation support "u" galvanisé - Vite per trave di sostegno - Schroef voor bevestiging balkhouder (gordingschoen) - Kruvi talakingale 	72	4x40	
HS12 5109	Screw for fixing fillet of door and window - Schrauben für fixierungsleiste - Vis pour profil vertical de fixation pour ouvertures des fenetres et portes - Viti per massello di fissaggio - Schroeven voor bevestiging van deur en raam lijsten - Kruvi tenderliistfudele 	36	4x40	
HS12 5109	Screw for door jamb - Schraube für türrahmen - Vis de fixation partie haute avec montants du cadre de porte - Viti x fissaggio montanti porte - Schroef voor deurkozijn - Kruvi ukse lengile 	9	4x40	
HS33 5112	Screw for door jamb - Schraube für türrahmen - Vis de fixation partie haute avec montants du cadre de porte - Viti x fissaggio montanti porte - Schroef voor deurkozijn - Kruvi ukse lengile 	8	5x40	

Pos	28.07.2023 Piece list - Stückliste - Liste des pièces - Elementi - Stuklijst - Tükitalabel Art. Nr. 4431419 8/8	Q	P (mm)	L (mm)
HS16 5115	Screw for foundation - Schrauben zur Befestigung Fundament - Vis de fixations des poutrelles de fondations - Viti x fundamenta - Schroef voor fundering - Kruvi alusraamile 	16	5x90	
HS16 5115	Screw for post - Schrauben für Pfosten - Vis de fixation des poteaux - Viti per inviare - Schroef voor stijlen - Kruvi postile 	9	5x90	
HS16 5115	Screw for roof edge reinforcement - Schrauben für Dachrandverstärkung - Vis pour fixation corniere renfort de bord de toit - Viti x rinforzo bordo tetto - Schroef voor dakrand versterking - Kruvi räästatugevdusele 	28	5x90	
HS16 5115	Screw for wall details - Schraube für Wand Details - Vis pour mur details - Viti per elementi della porta - Schroef voor wand details - Kruvi seinadetailidele 	4	5x90	
HS16 5115	Screw for foundation - Schrauben zur Befestigung Fundament - Vis de fixations des poutrelles de fondations - Viti x fundamenta - Schroef voor fundering - Kruvi alusraamile 	11	5x90	
HS16 5115	Screw for door jamb - Schraube für Türrahmen - Vis de fixation partie haute avec montants du cadre de porte - Viti x fissaggio montanti porte - Schroef voor deurkozijn - Kruvi ukse lengile 	8	5x90	
HS22 5120	Screw for 1. wall beam - Schraube für 1. Bohlenreihe - Vis de fixations 1ere rangée de madriers avec poutrelles de fondations - Vite fissaggio alle fondamenta - Schroef voor 1 wandbalk - Kruvi pooltauale 	11	6x150	
HS23 5121	Screw for wall details - Schraube für Wand Details - Vis pour mur details - Viti per elementi della porta - Schroef voor wand details - Kruvi seinadetailidele 	78	6x180	
HS21 5119	Screw for beam - Schrauben zur Befestigung Dachsparren - Vis pour solive - Viti per perline - Schroef voor balk (gording) - Kruvi talale 	10	6x80	
NF2 5127	Zn nail for floor fillet - Zn Nägel für Fussbodenleiste - Pointe pour corniere de finition du plancher - Chiodi x fissaggio pavimento - Spijker(nagel) voor vloer afdekljst - Nael põrandaliistule 	25	1.4x40	
SH44 32512	Hammer block - Schlagholz - Calle de frappe - Blocco di legno da usare come cuscinetto quando si usa il martello - Slagklos - Löögiklots 	1		
NF4 5137	Zn nail for roof - Zn Nägel für Dachbretter - Pointe pour fixation voliges de toit - Chiodi x perline tetto - Spijker(nagel) voor dakhout - Nael katuselauale 	340	2x50	
NF4 5137	Zn nail for floor - Zn Nägel für Fussbodenbretter - Clous pour plancher - Chiodi x perline pavimento - Spijker(nagel) voor vloer - Nael põrandalauale 	170	2x50	
5141	Metal corner - Metallwinkel - Corniere en métal - Angolo di metallo - Metalen hoek - Nurgik 	2	120x80x40	
NF5 5145	Zn nail for roofing felt fillet - Zn Nägel für Dachpappenleiste - Pointe pour baguette de fixation feutre bitumeux - Chiodi x carta bituminosa x tetto - Spijker(nagel) voor asfalt papier afdekljst - Papiliistunael 	24	2x40	
BM 37607	Beam holder - Balkenhalter - Support en u galvanisé - Supporto della trave Balkendrager (gording schoen) - Talaking 	6	45x137	
	<p>To prevent splits in the wood, we recommend pre-drilling screw holes.</p> <p>Um der Rissbildung im Holz vorzubeugen, empfehlen wir, die Schraubenlöcher vorzubohren.</p> <p>Afin d'éviter le risque de fissuration du bois nous recommandons de percer auparavant les trous des vis.</p> <p>Per impedire avvitando le viti autofilettanti dell'insorgere di crepe nel legno, si consiglia di pre forare il legno con un trapano.</p> <p>Om scheuren van het hout te voorkomen, adviseren we om schroefgaten voor te boren.</p> <p>Ennetamaks puidu lõhenemist, soovitame kruviaugud ette puurida.</p>			

Art. Nr. 4431419

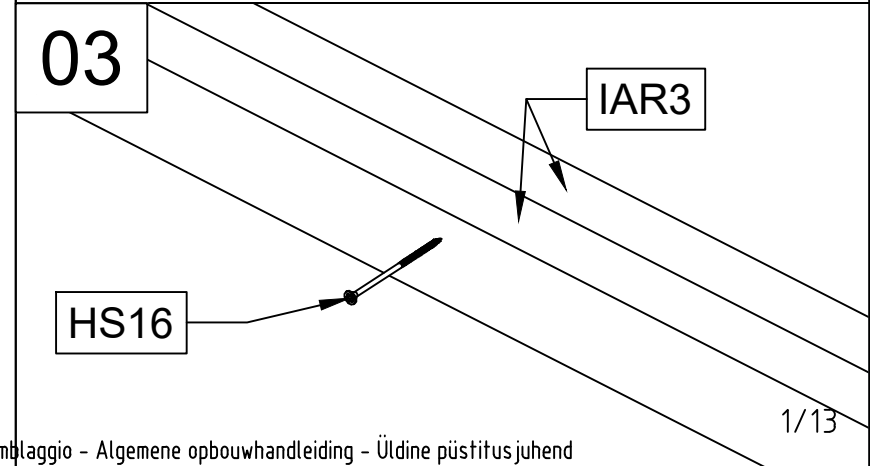
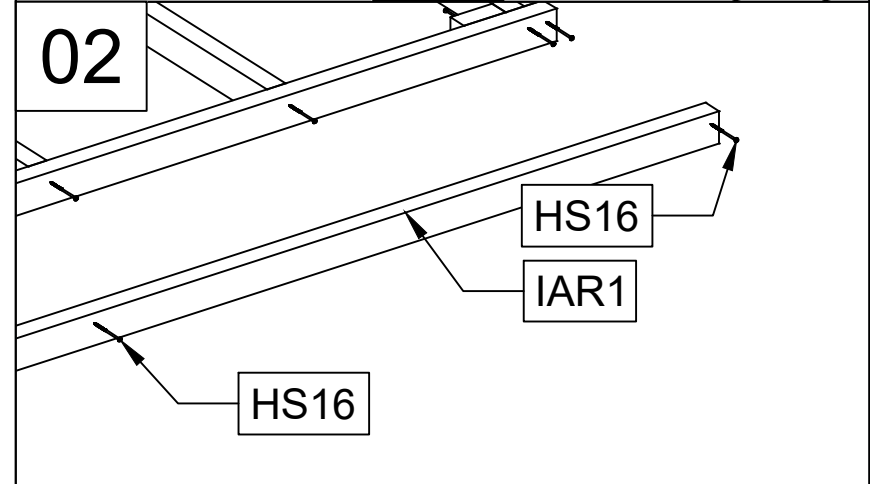
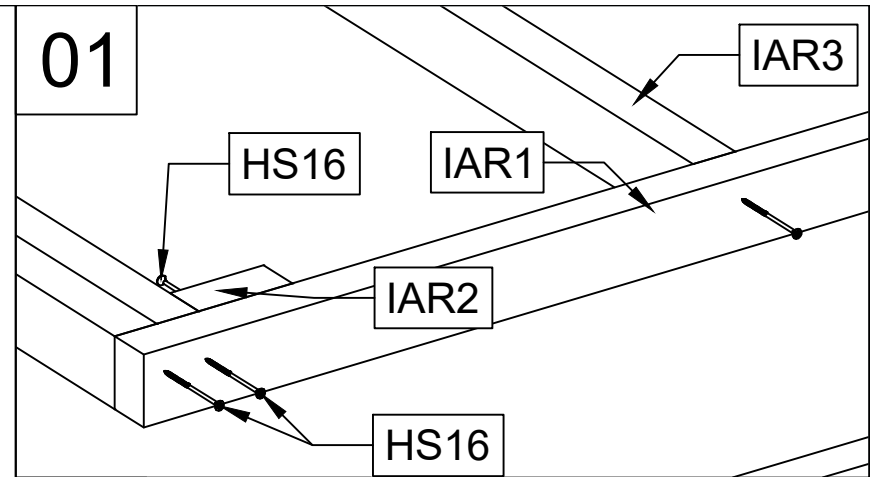
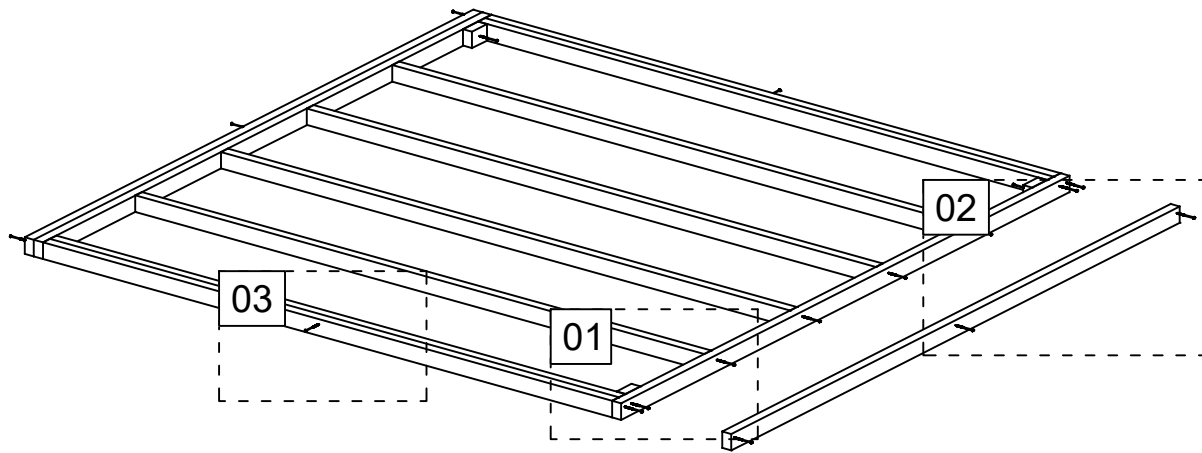

Art. Nr. 4431419

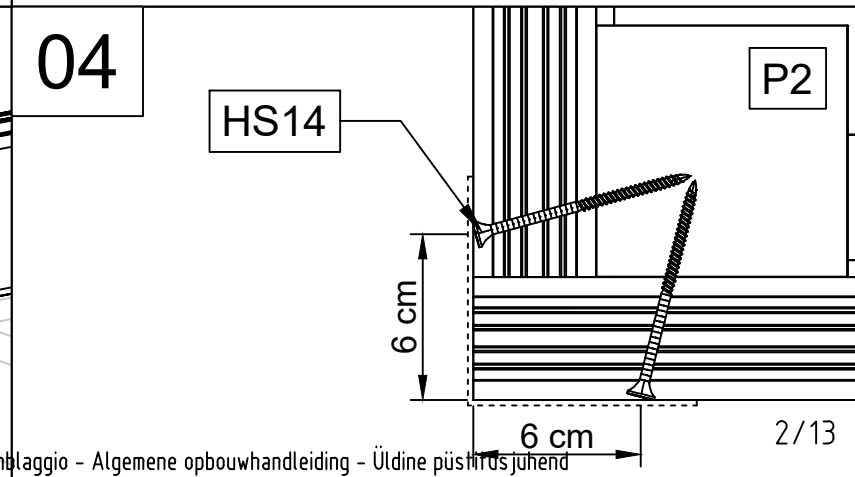
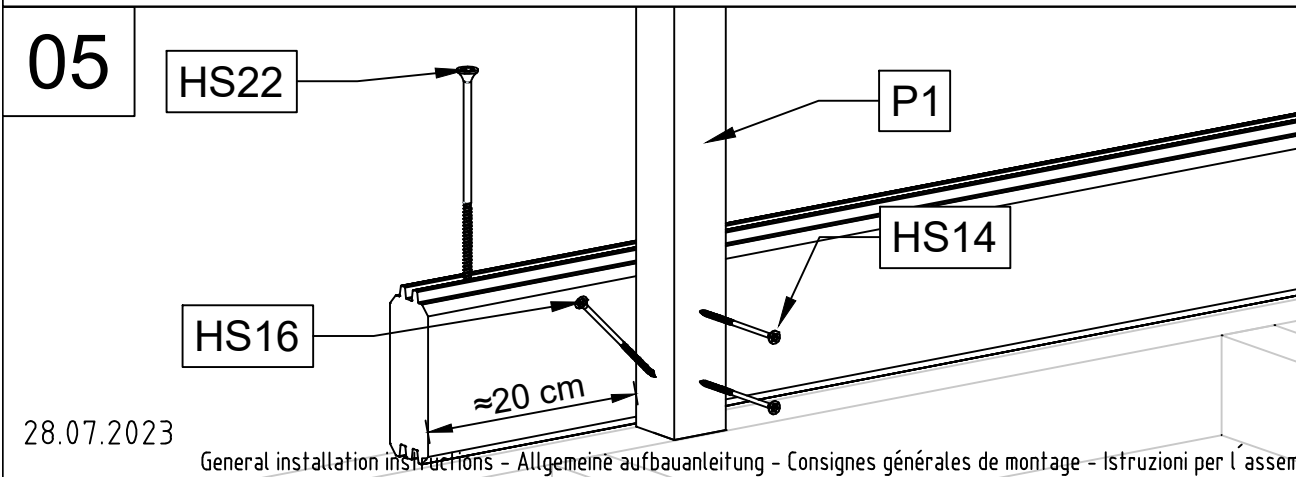
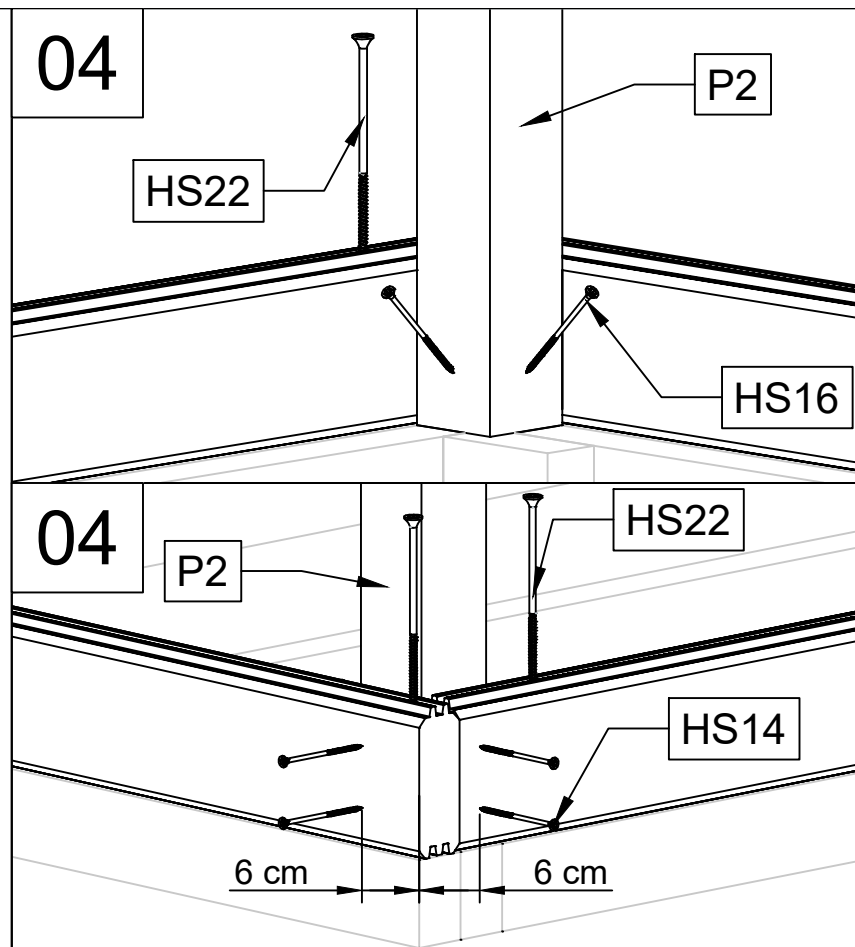
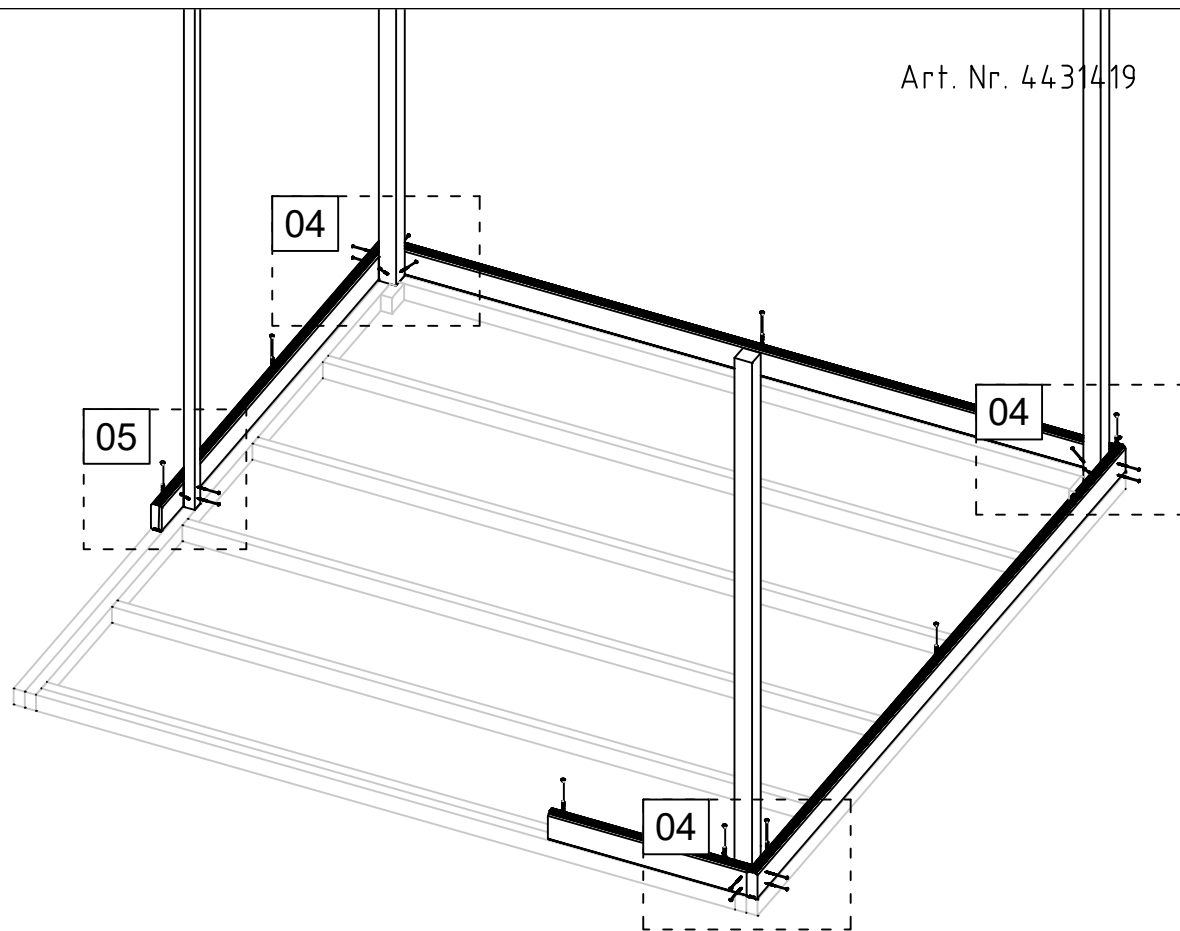

28.07.2023

General installation instructions - Allgemeine Aufbauanleitung - Consignes générales de montage - Istruzioni per l'assemblaggio - Algemene opbouwhandleiding - Üldine püstirühend

2/13

Art. Nr. 4431419

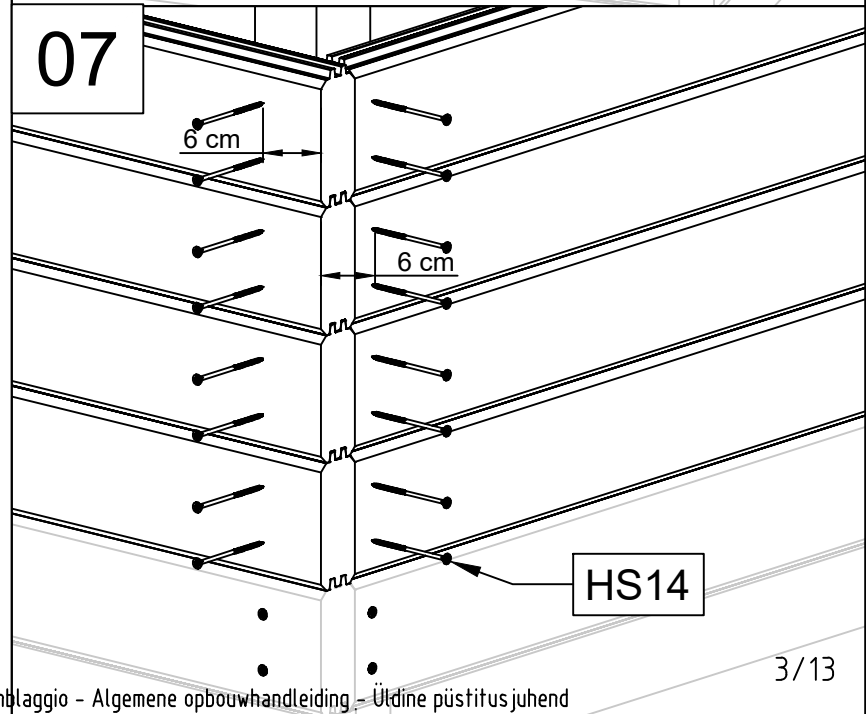
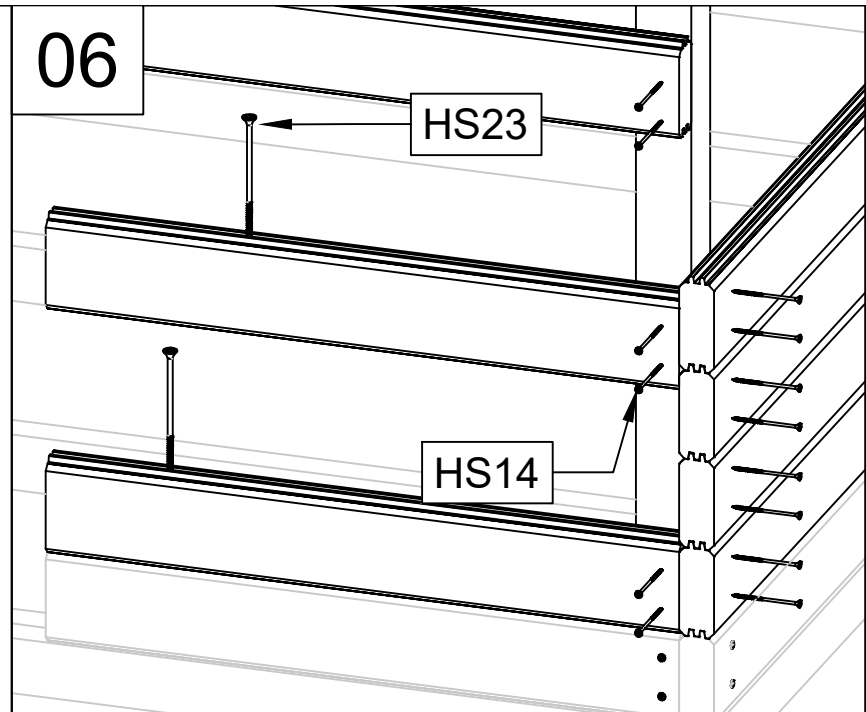
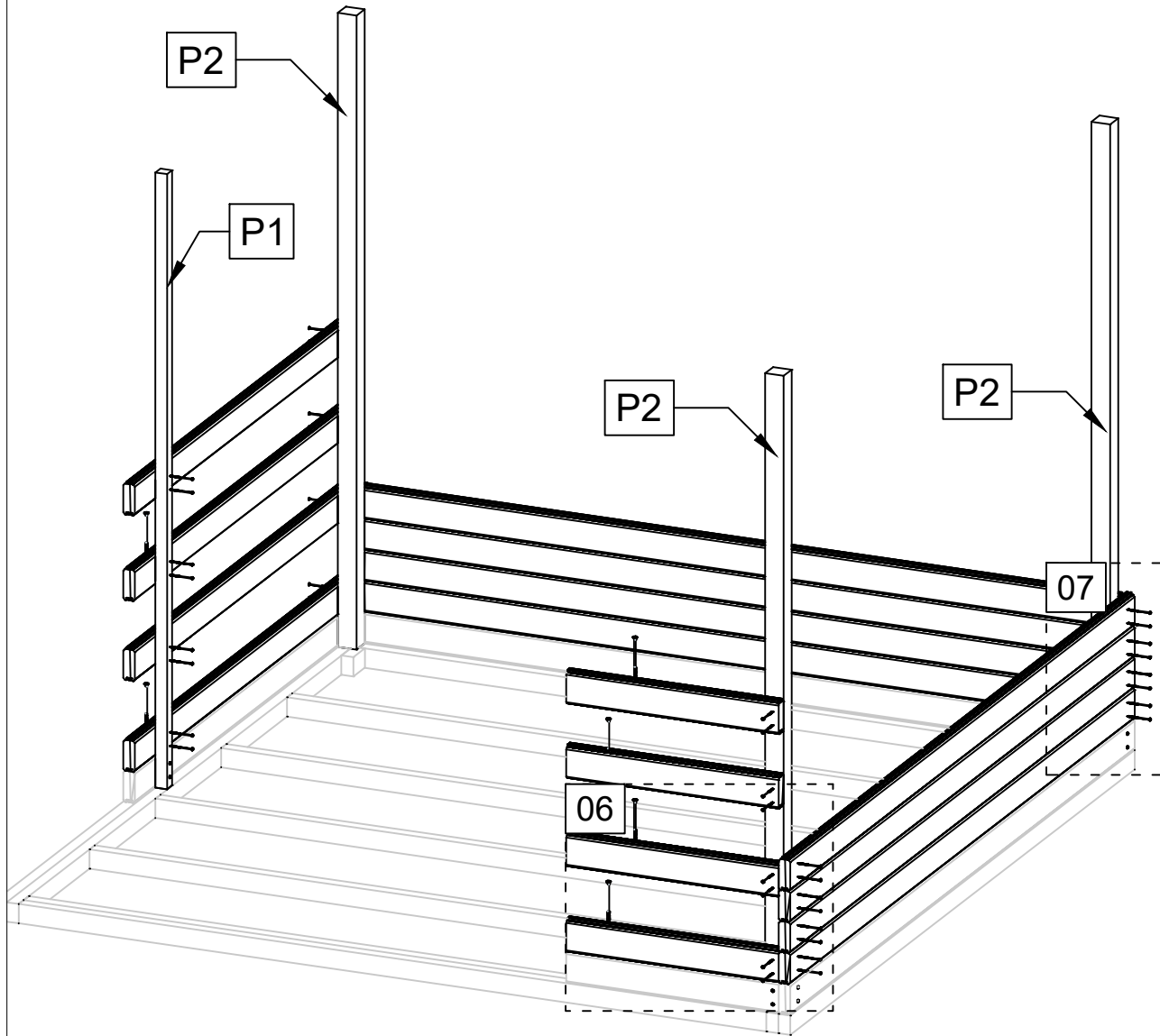

Art. Nr. 4431419

08

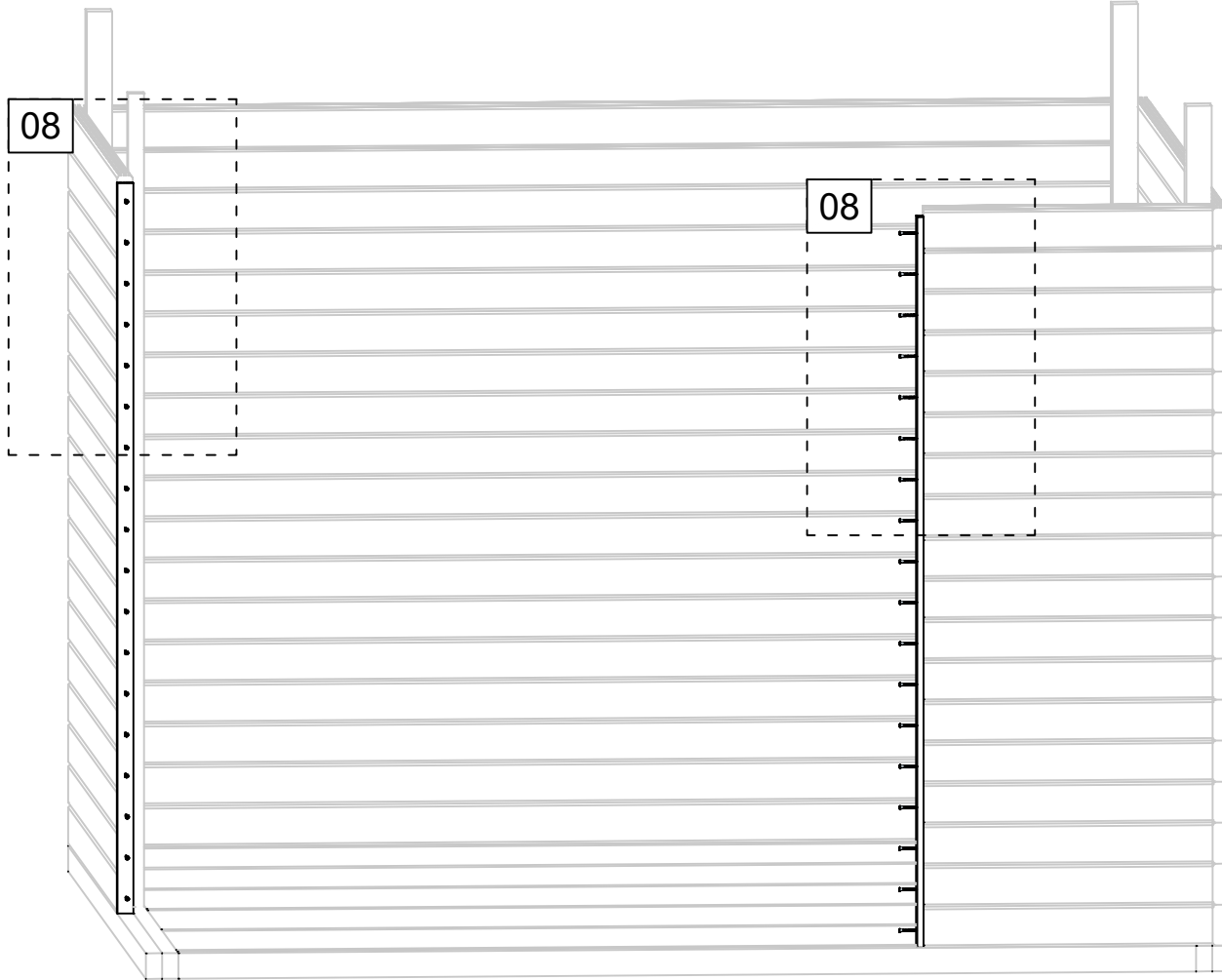

HS12

FF



Art. Nr. 4431419

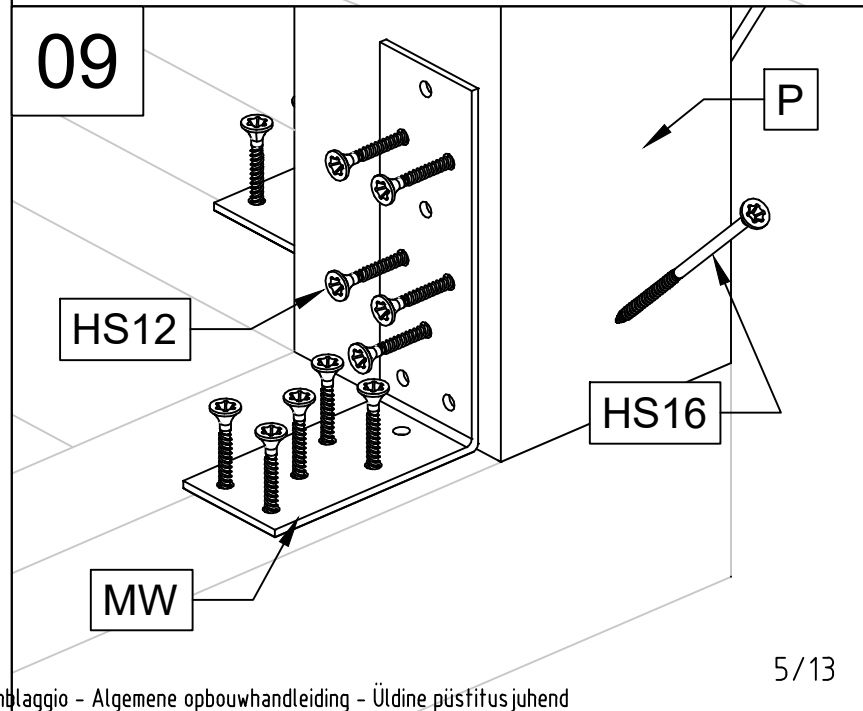
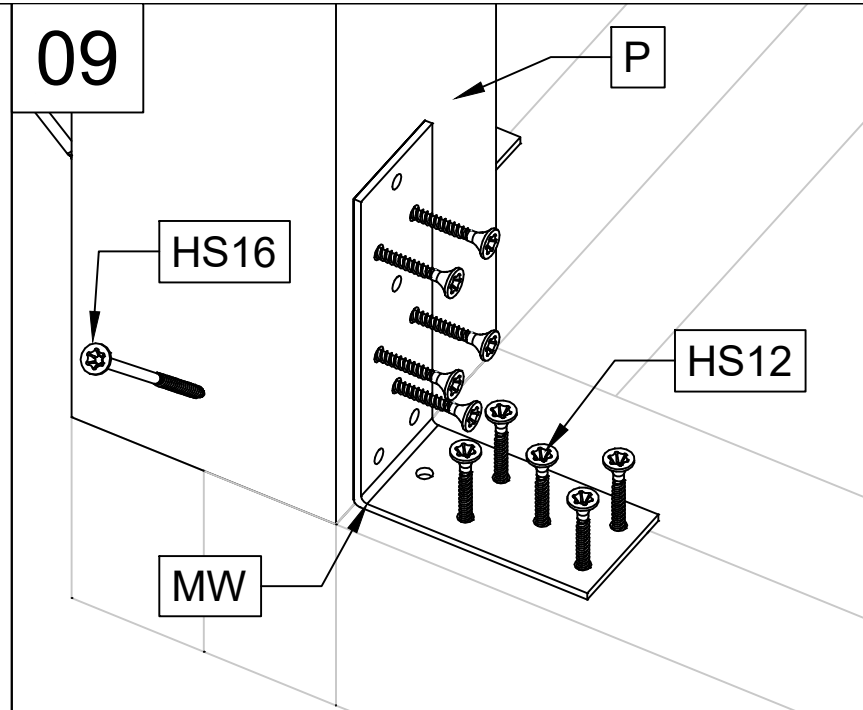
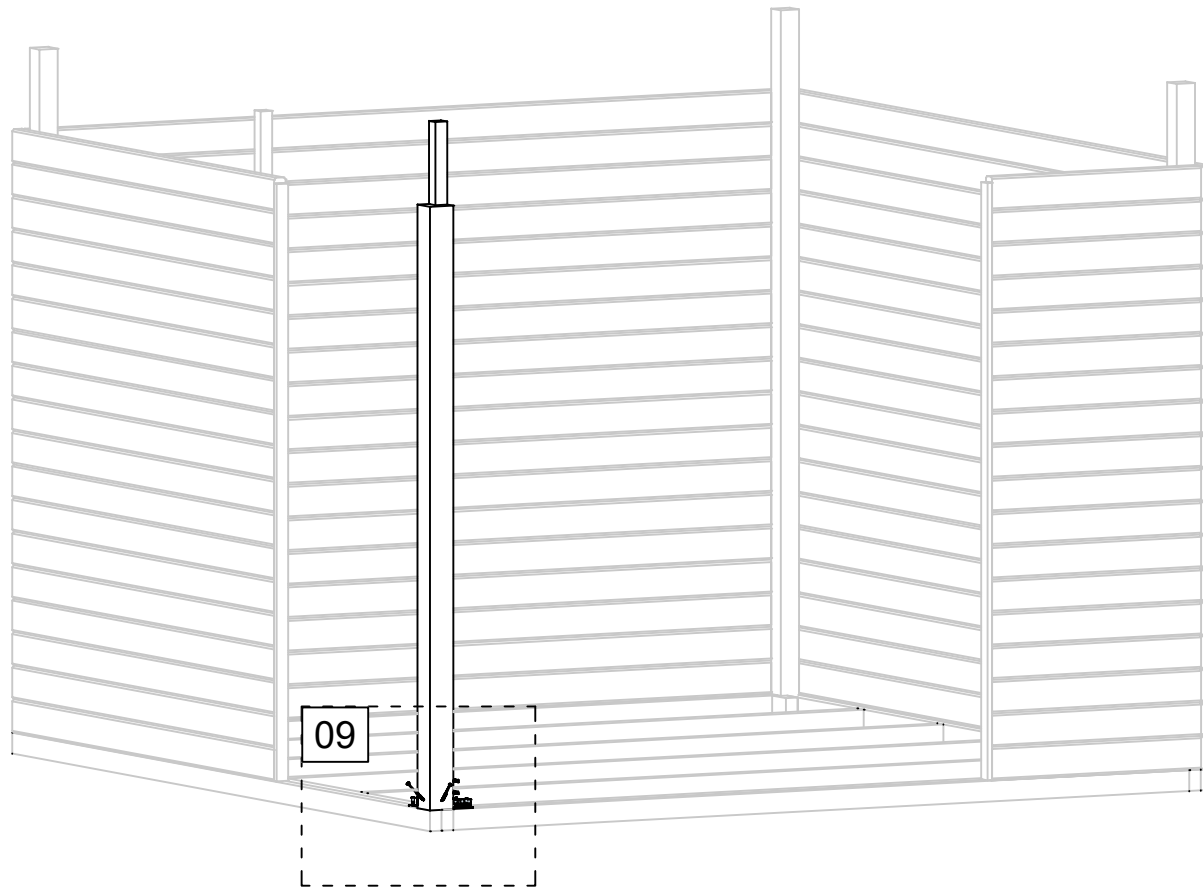

Art. Nr. 4431419

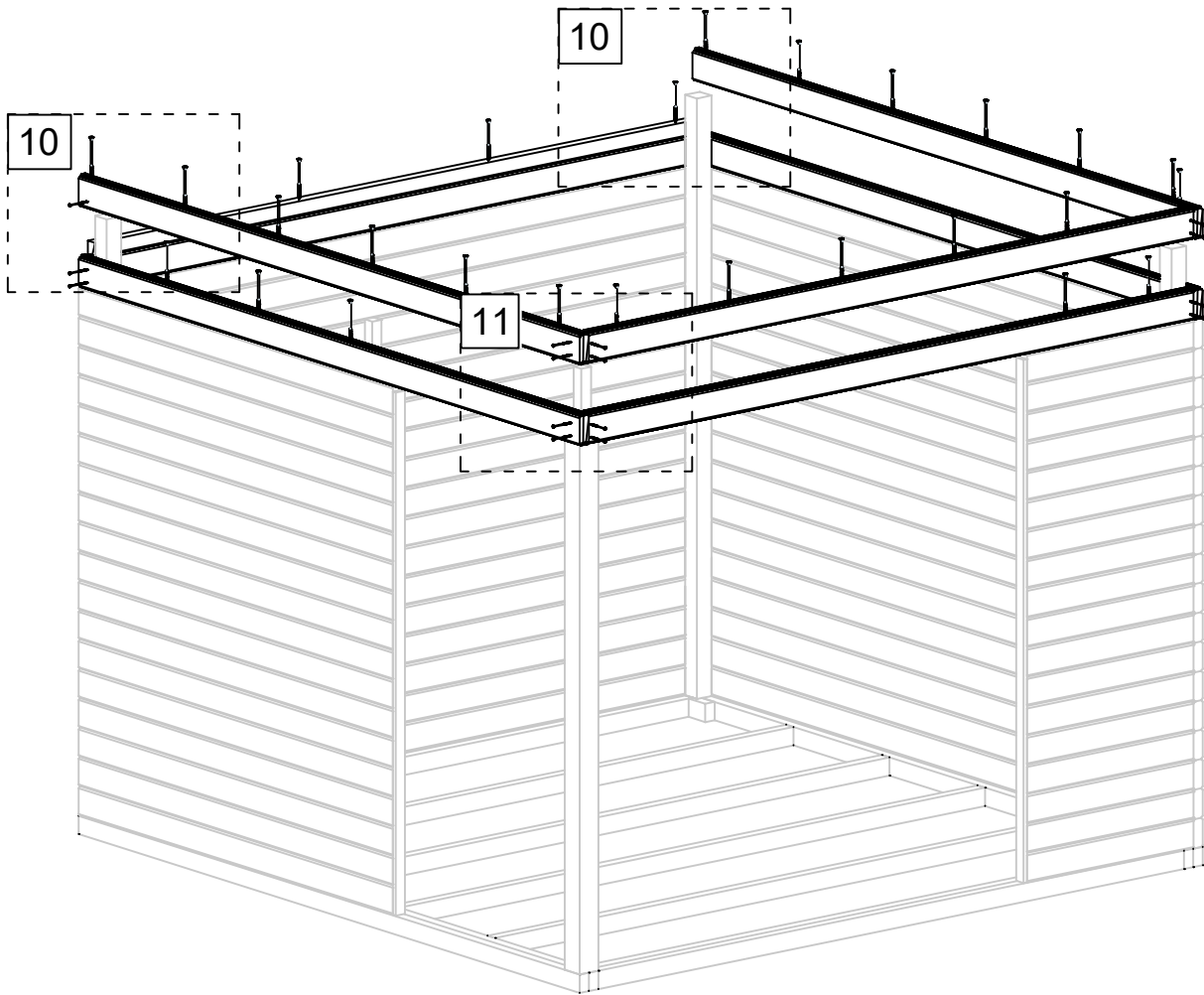

10

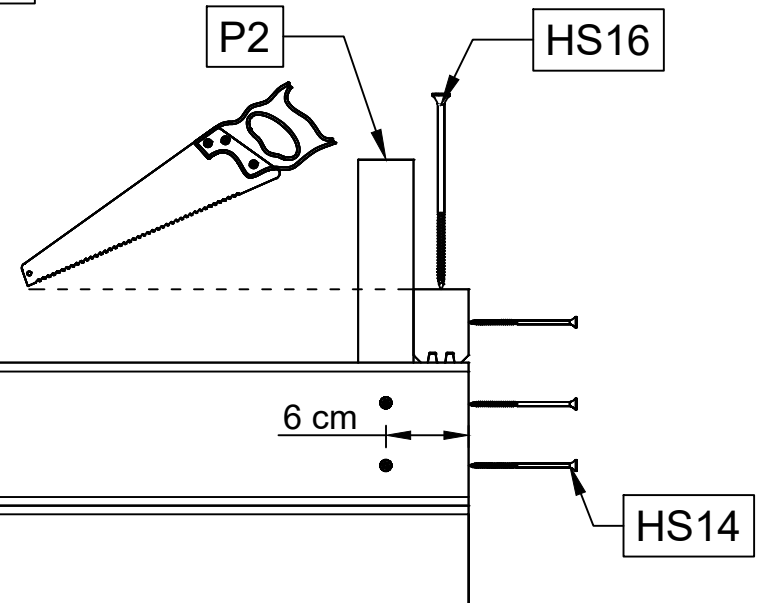

11

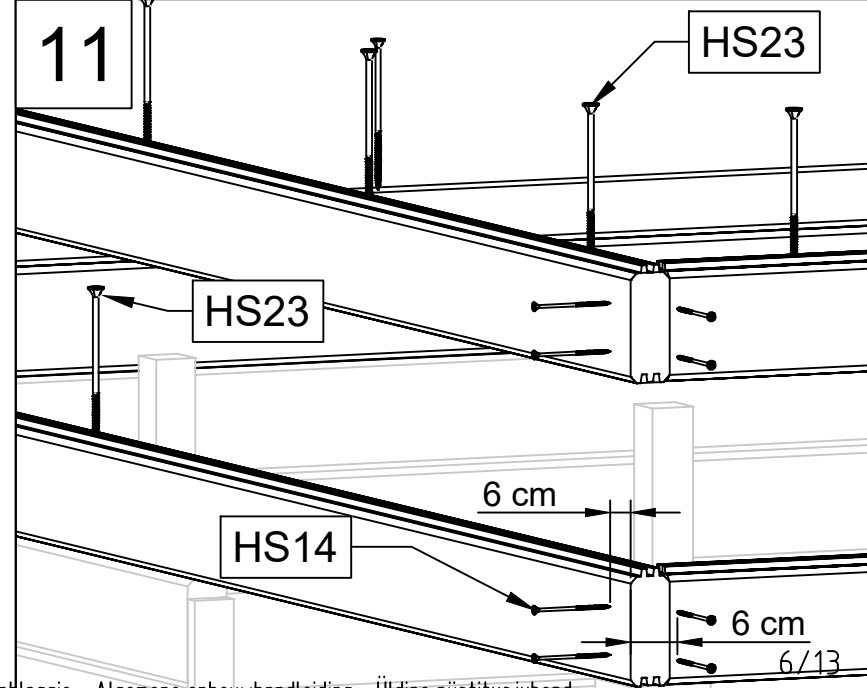

28.07.2023

General installation instructions - Allgemeine aufbauanleitung - Consignes générales de montage - Istruzioni per l'assemblaggio - Algemene opbouwhandleiding - Üldine püstitusjuhend

6/13

Art. Nr. 4431419

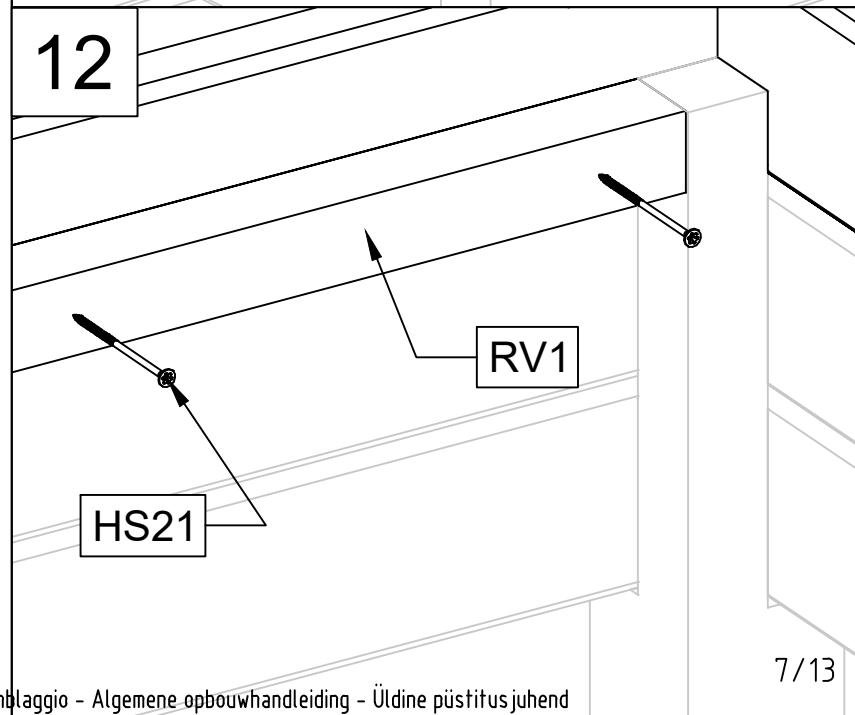
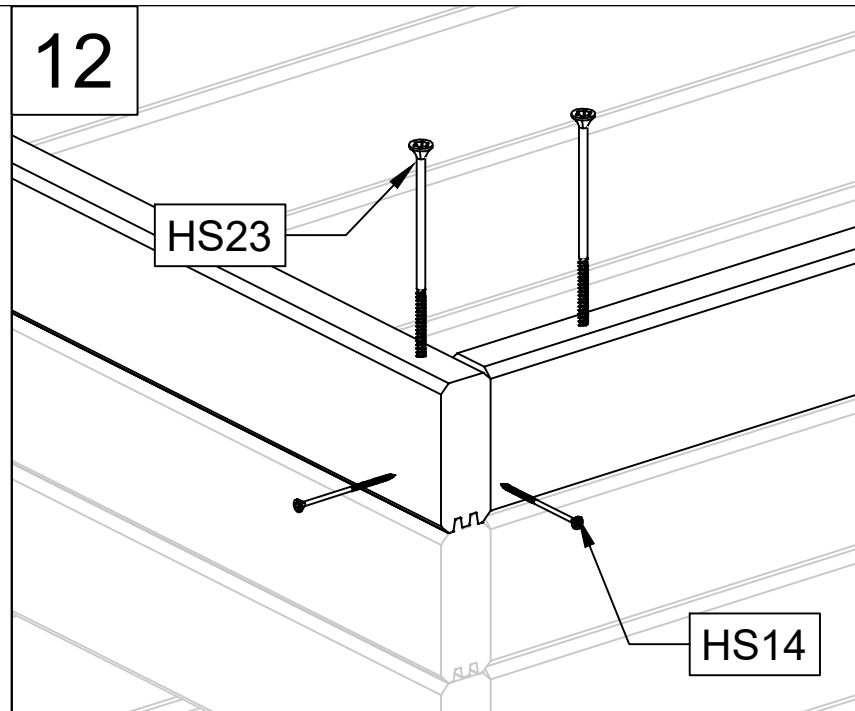
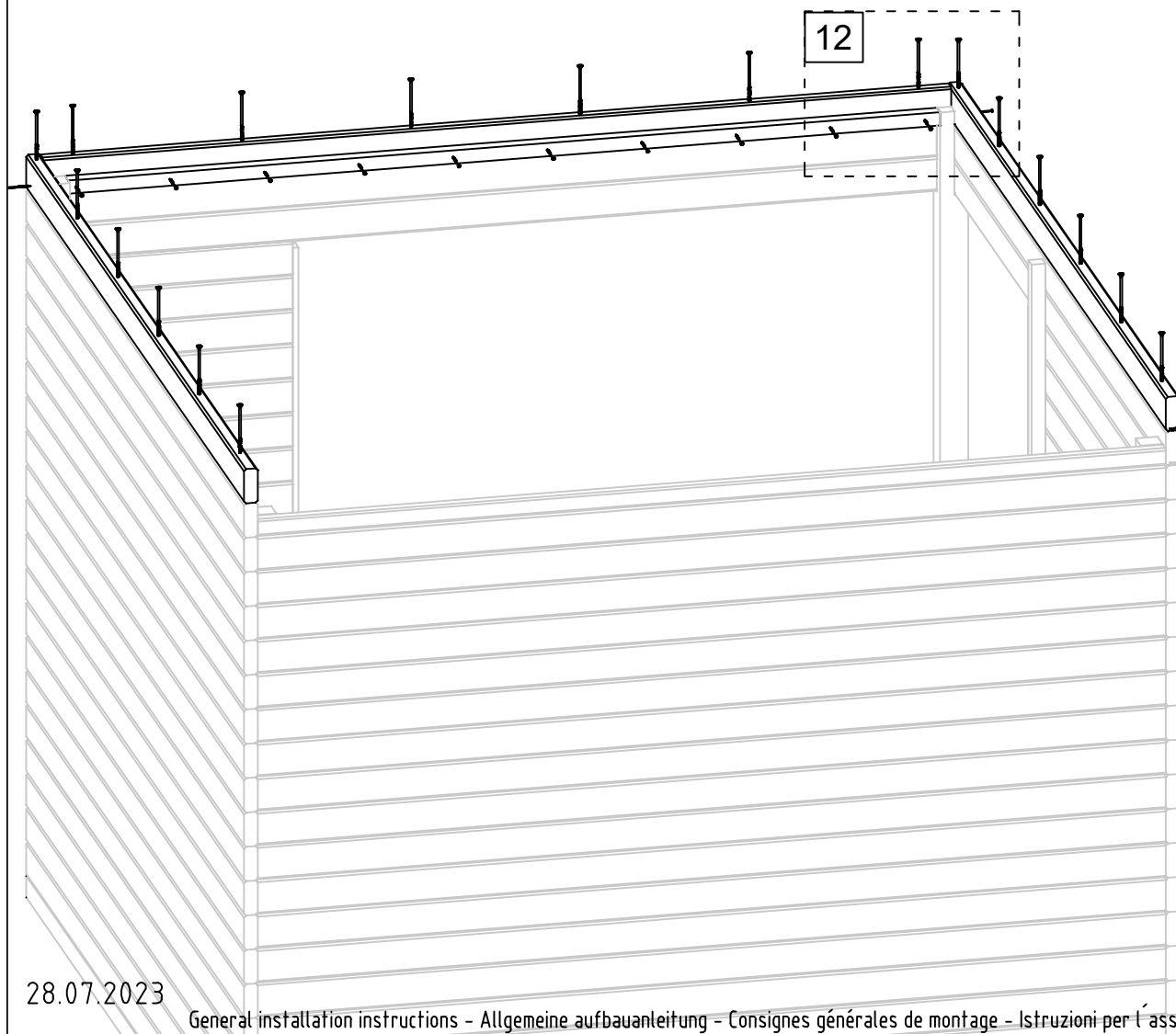

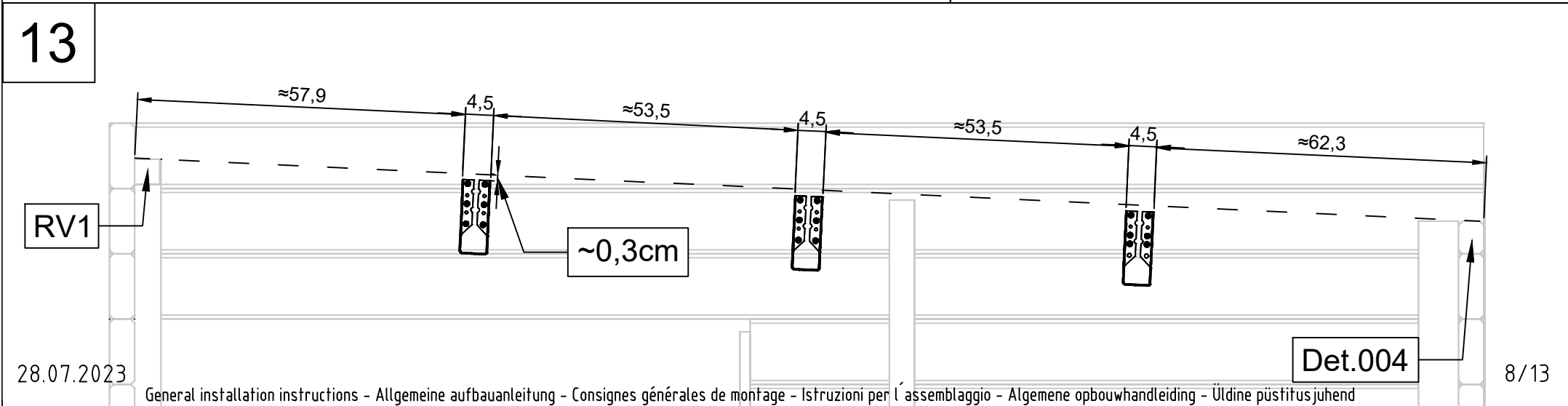
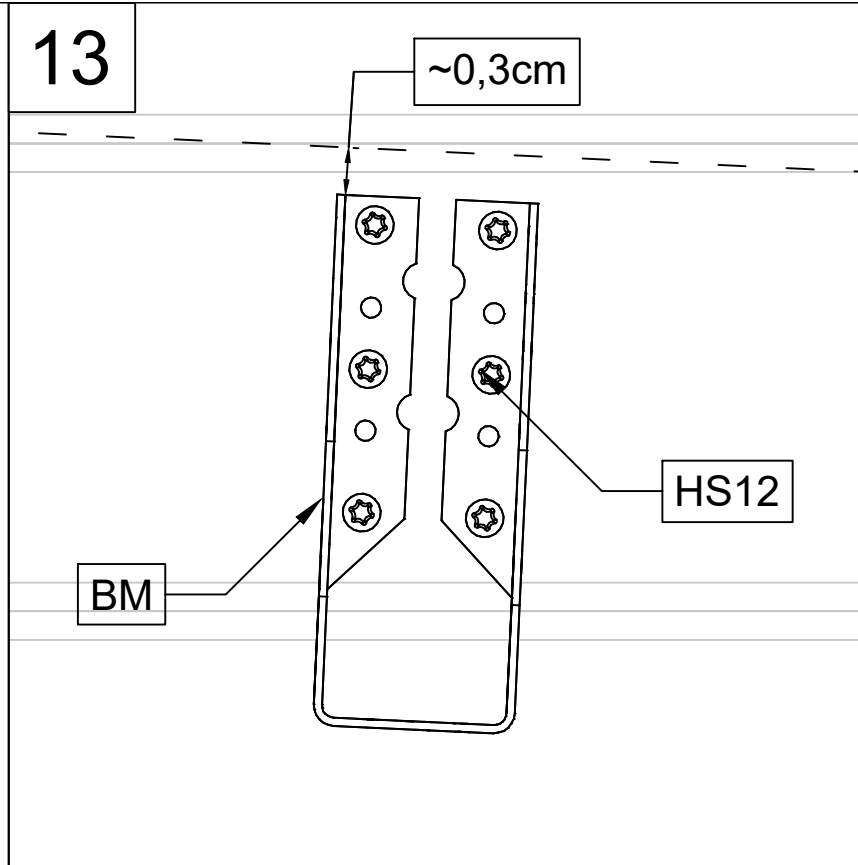
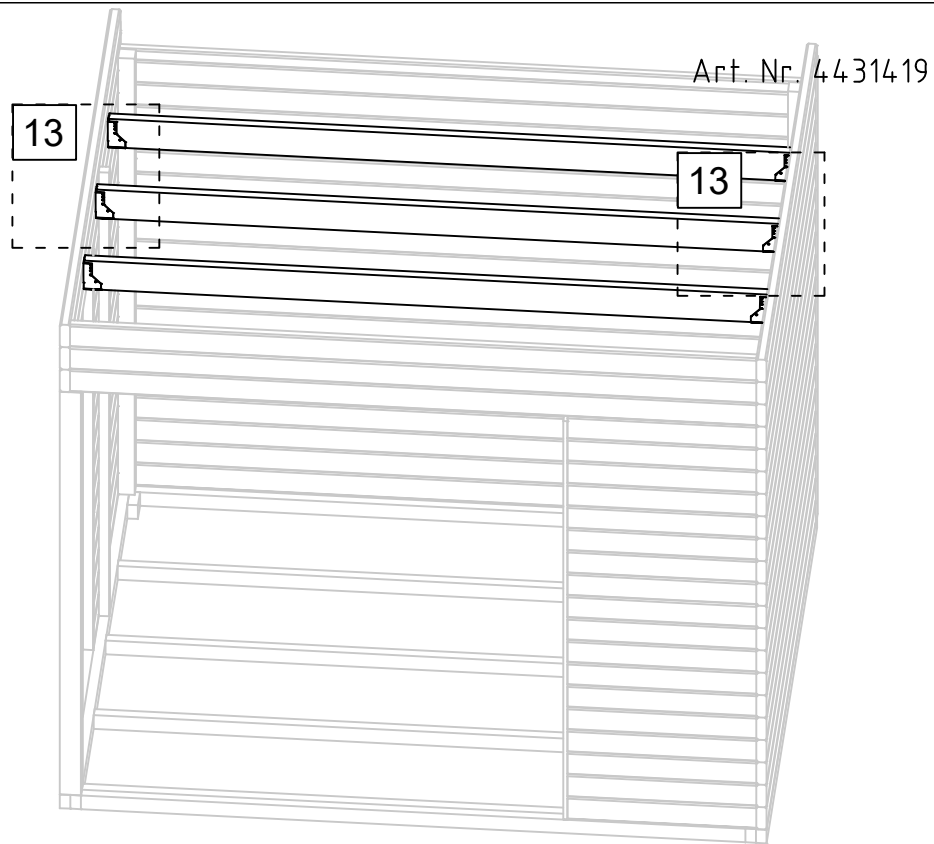

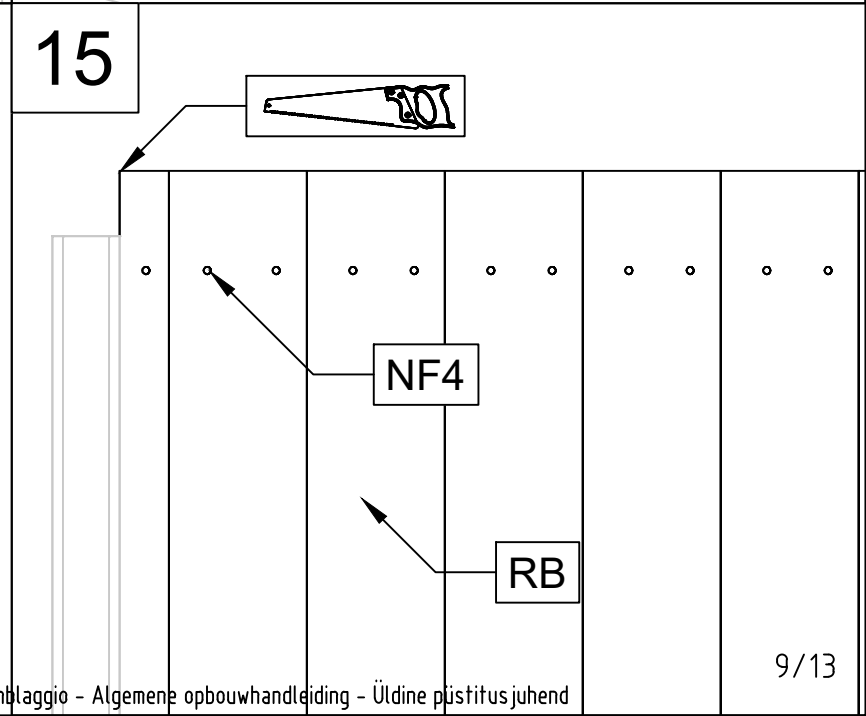
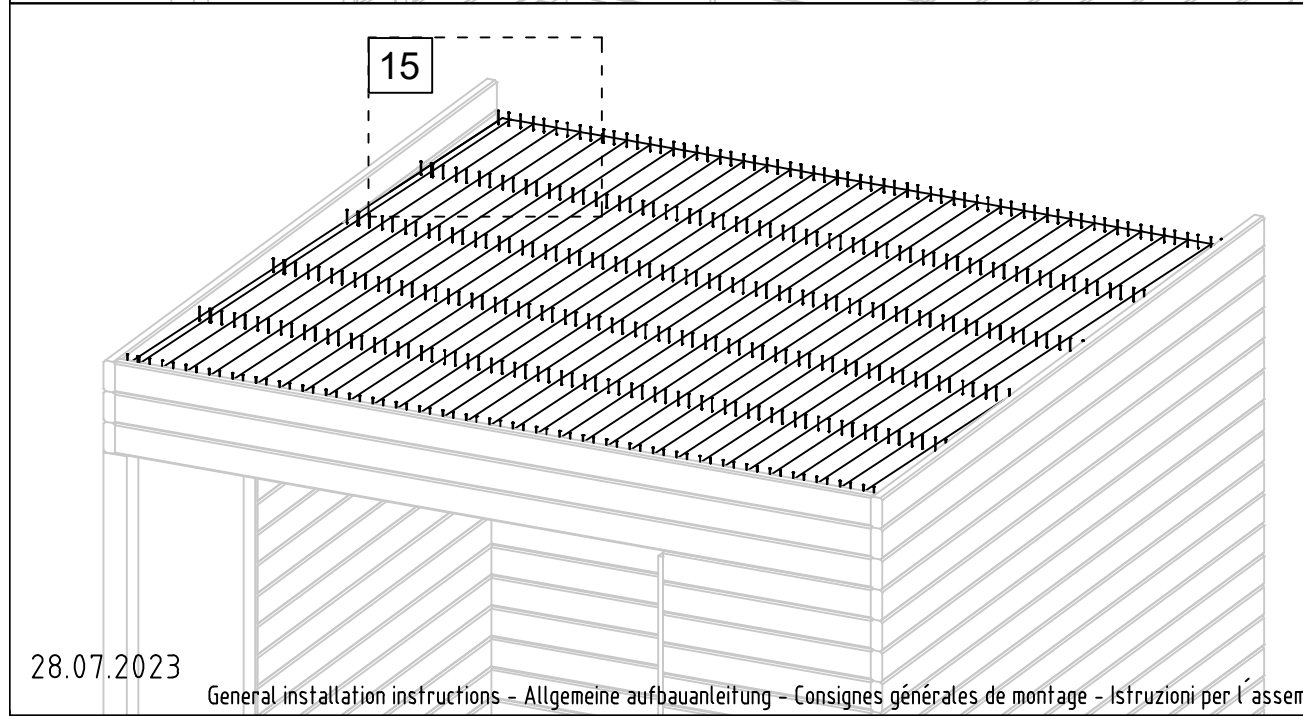
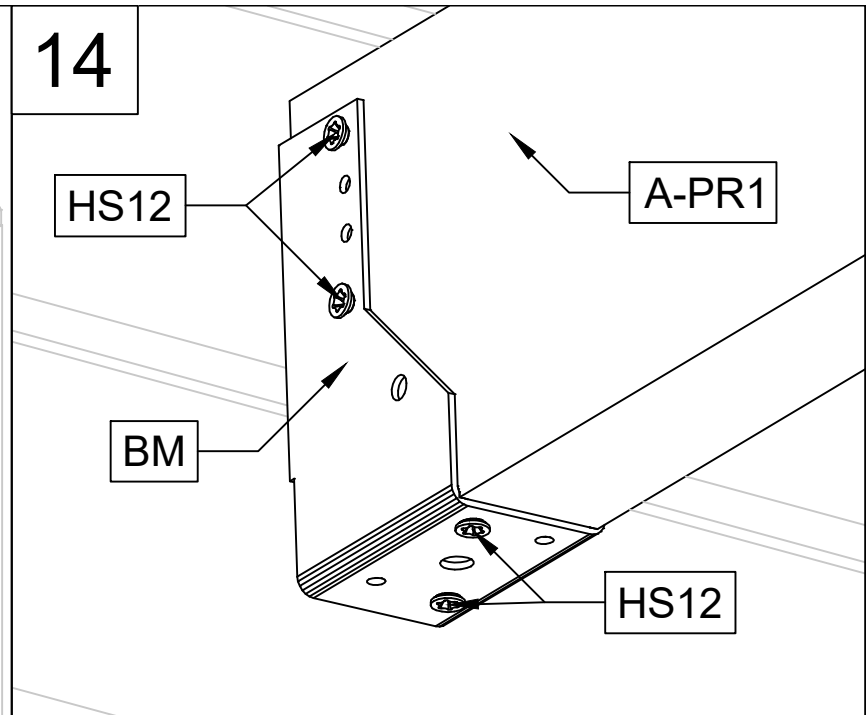
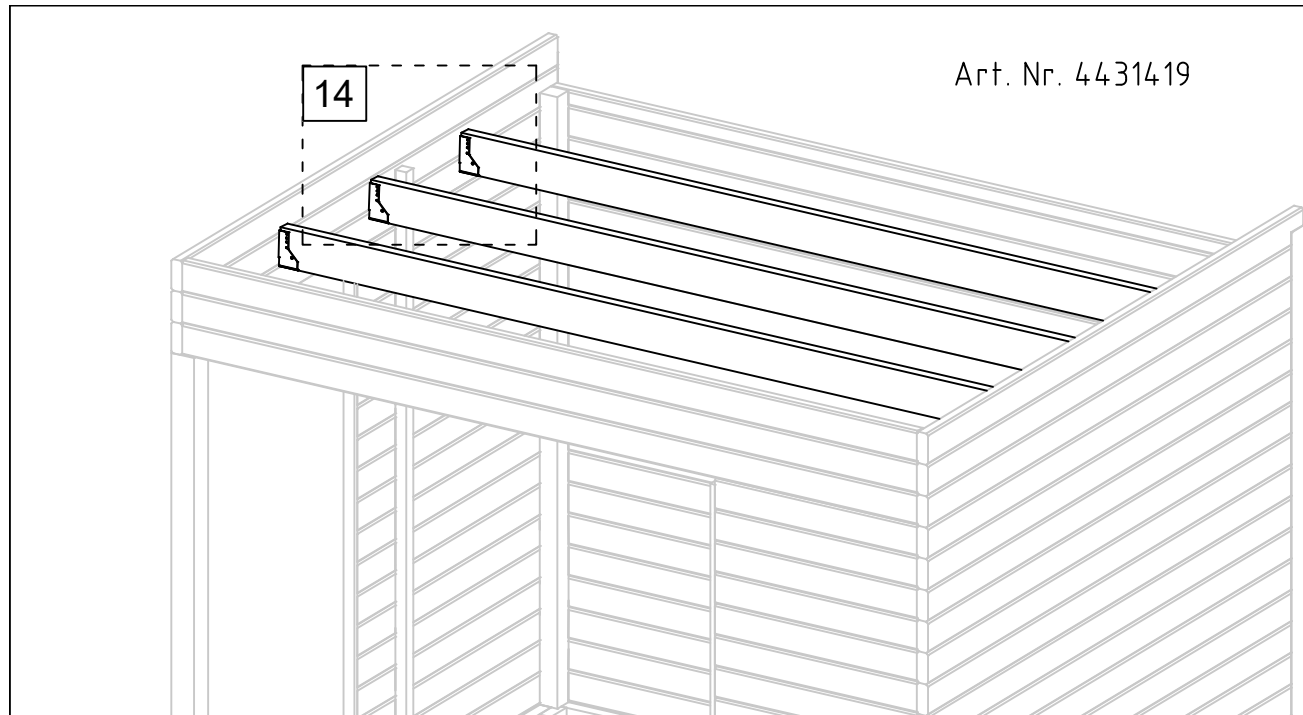

Art. Nr. 4431419

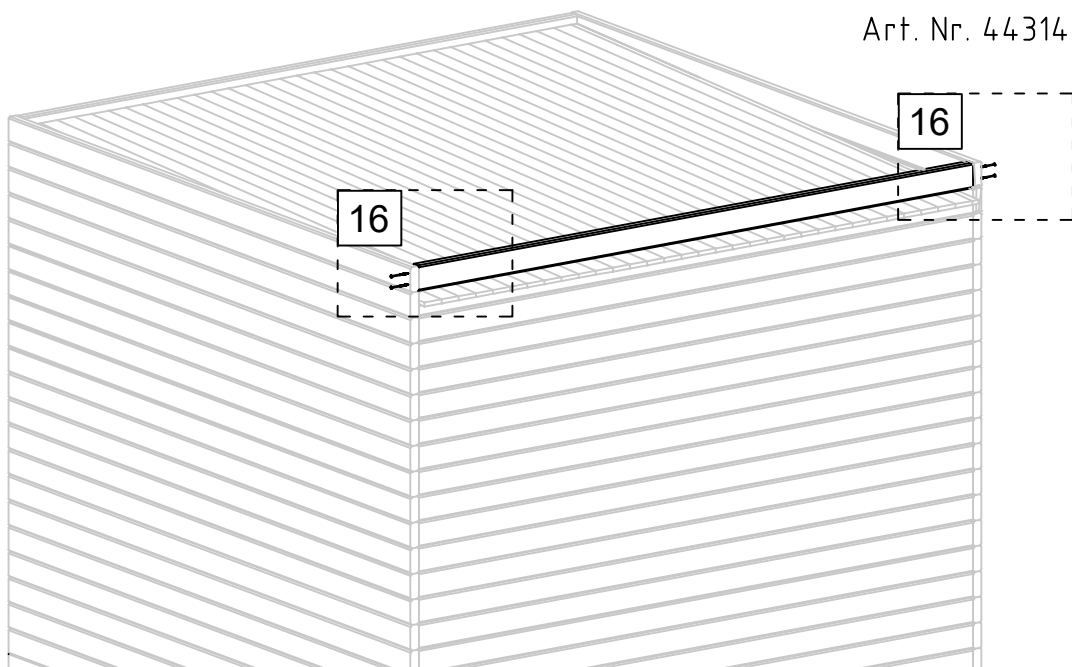

16

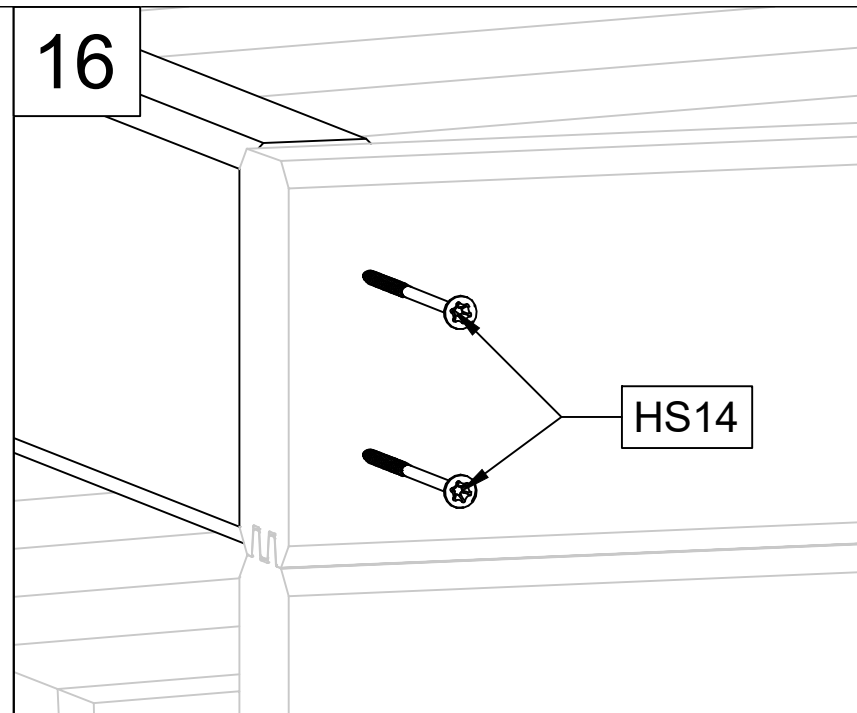

HS14

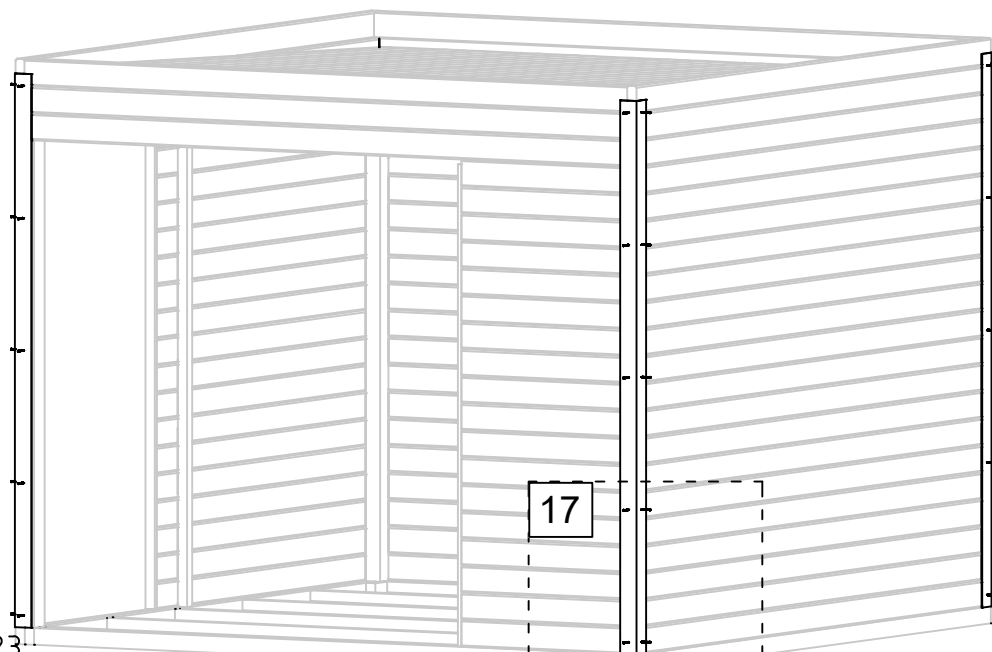

17

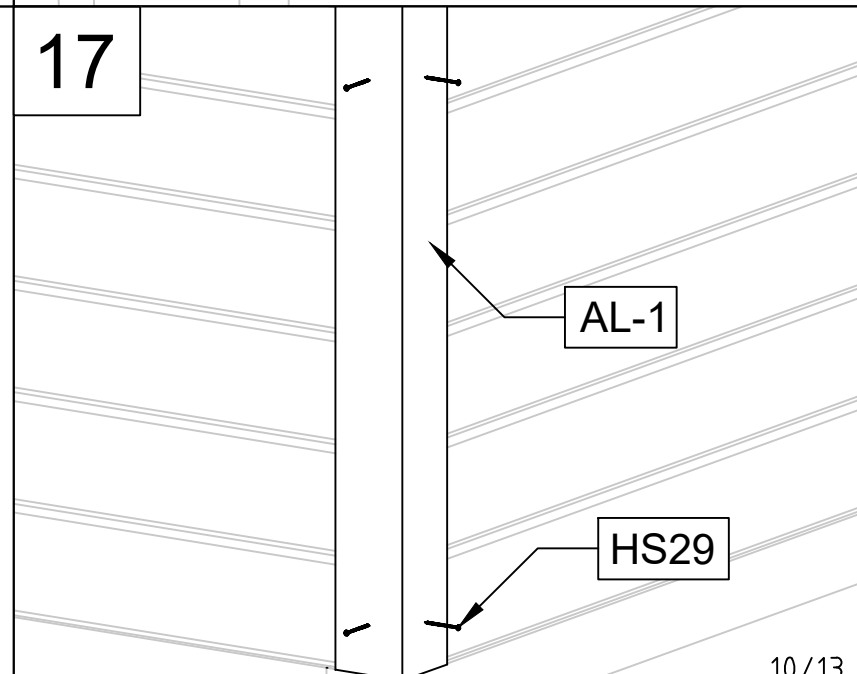

AL-1

HS29

28.07.2023

Art. Nr. 4431419

20

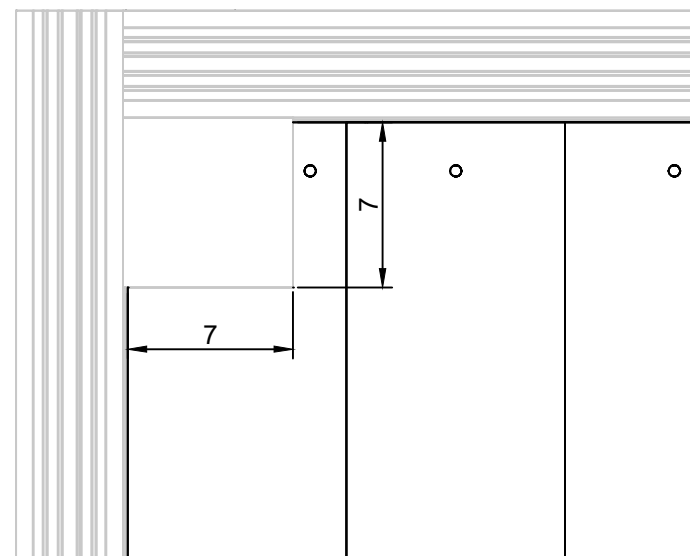
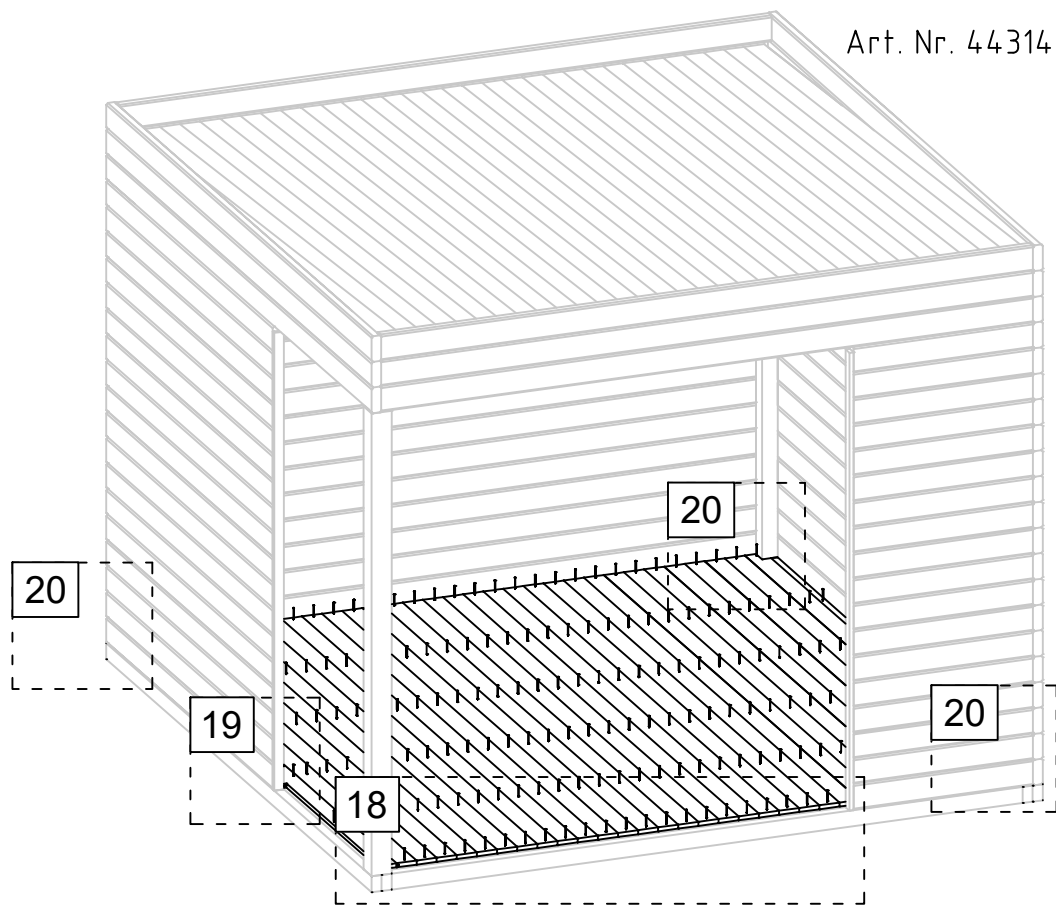

19

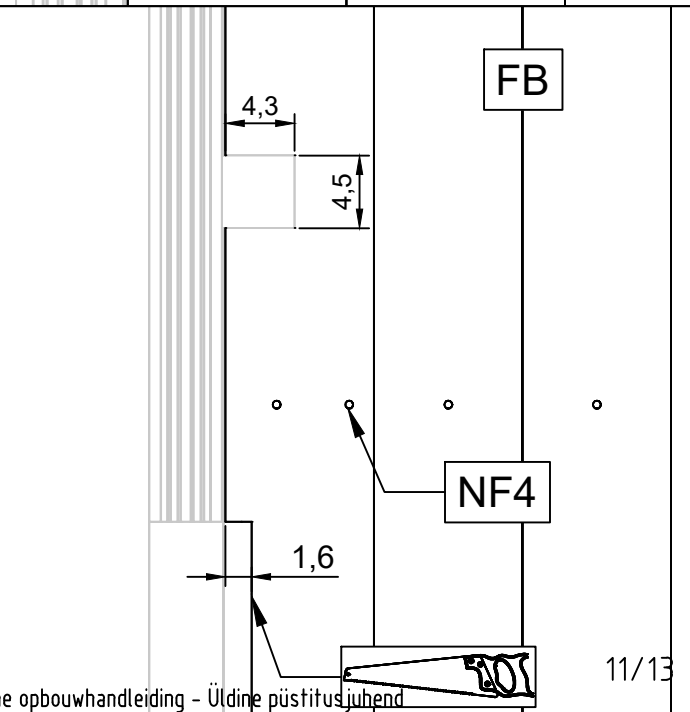

18

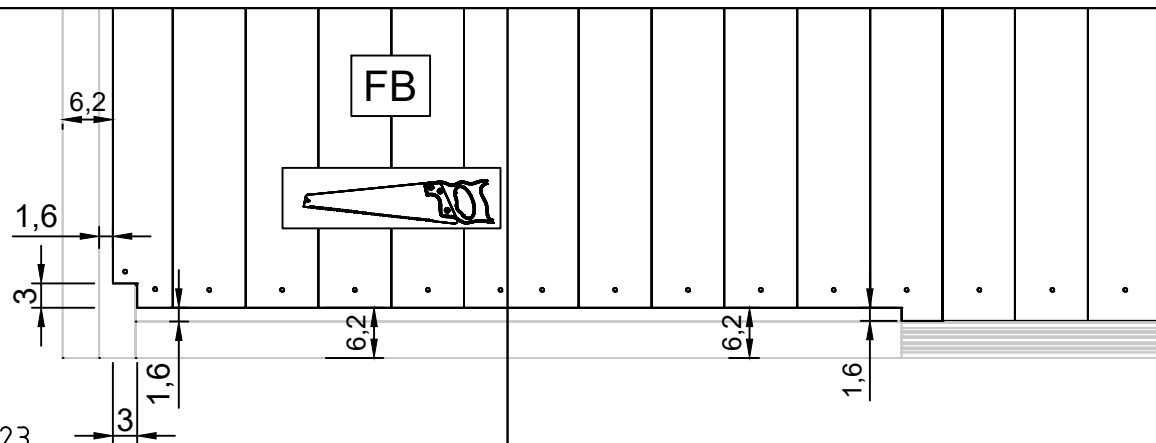

28.07.2023

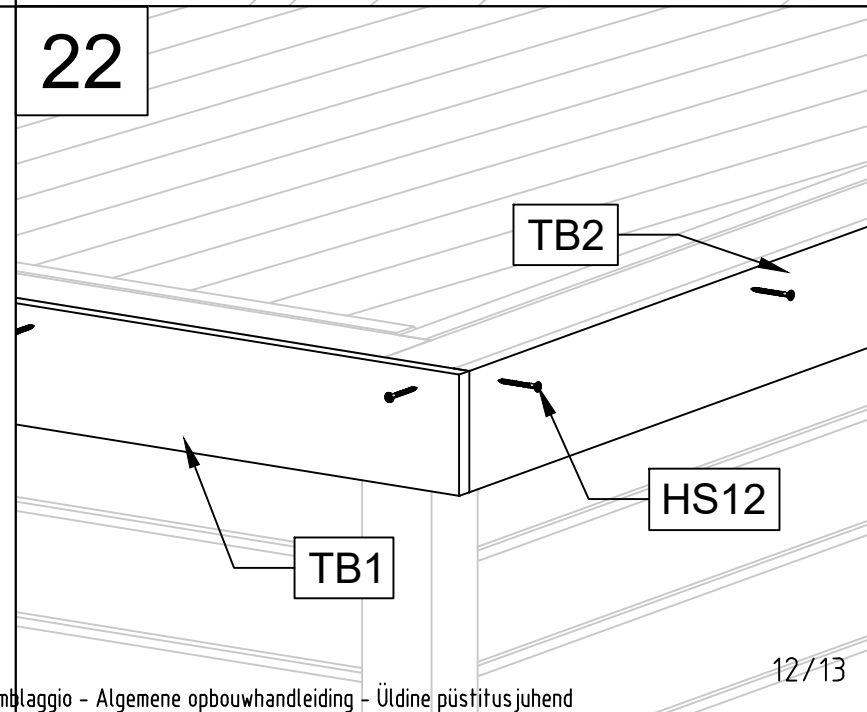
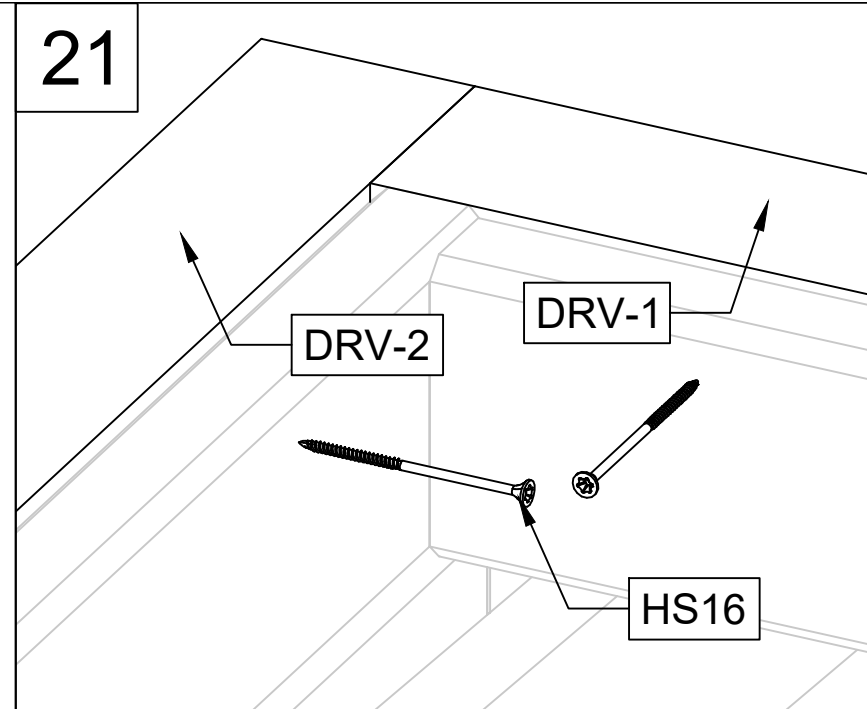
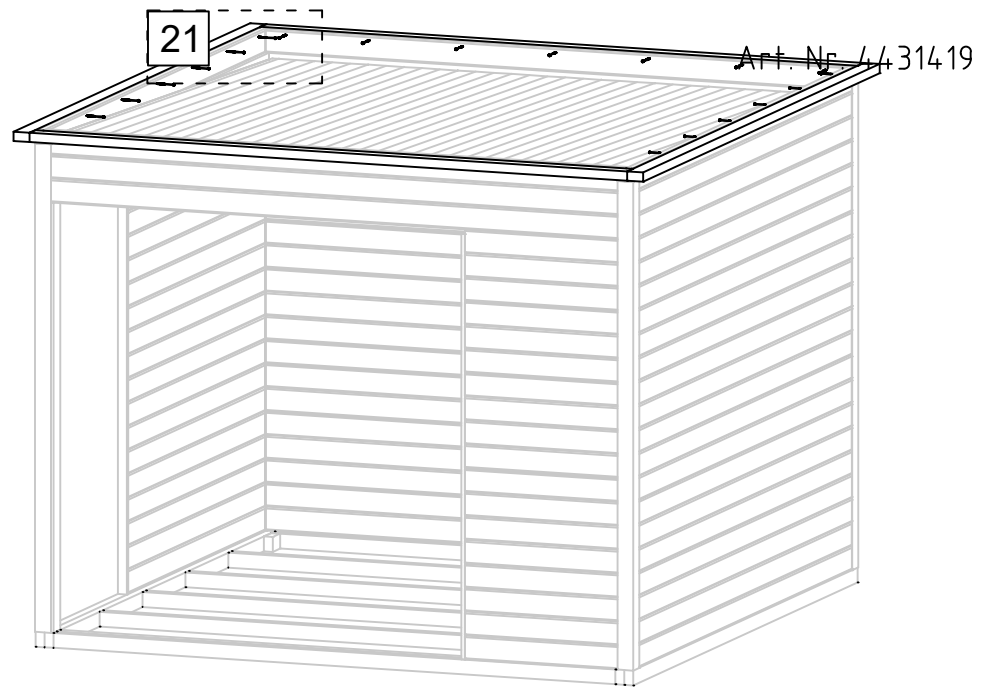

Art. Nr. 4431419

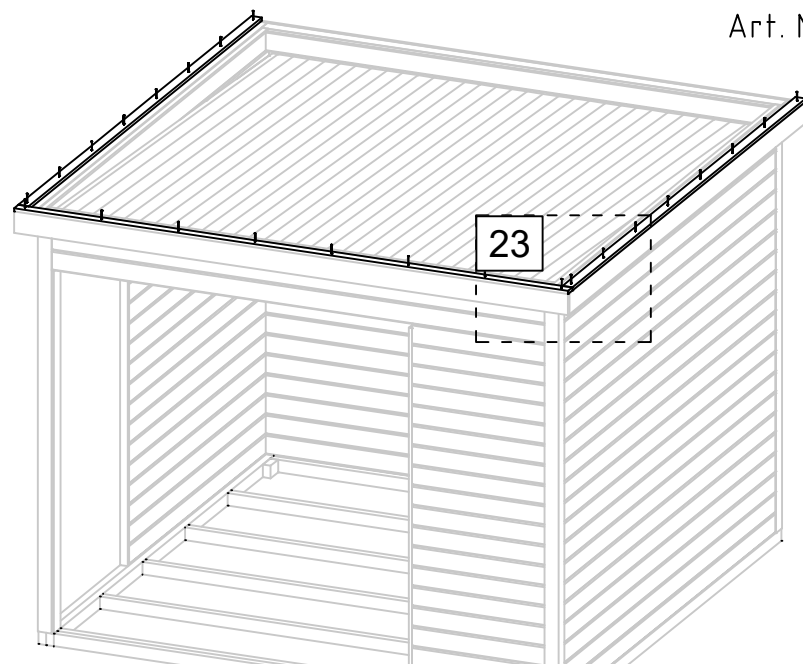

23

