

*Rivera 44*  
*Art. Nr. 4416802*  
1/15



20.04.2016

Art.Nr. 4416802

GROUNDPLAN - GRUNDPLAN - PLAN DE MASSE

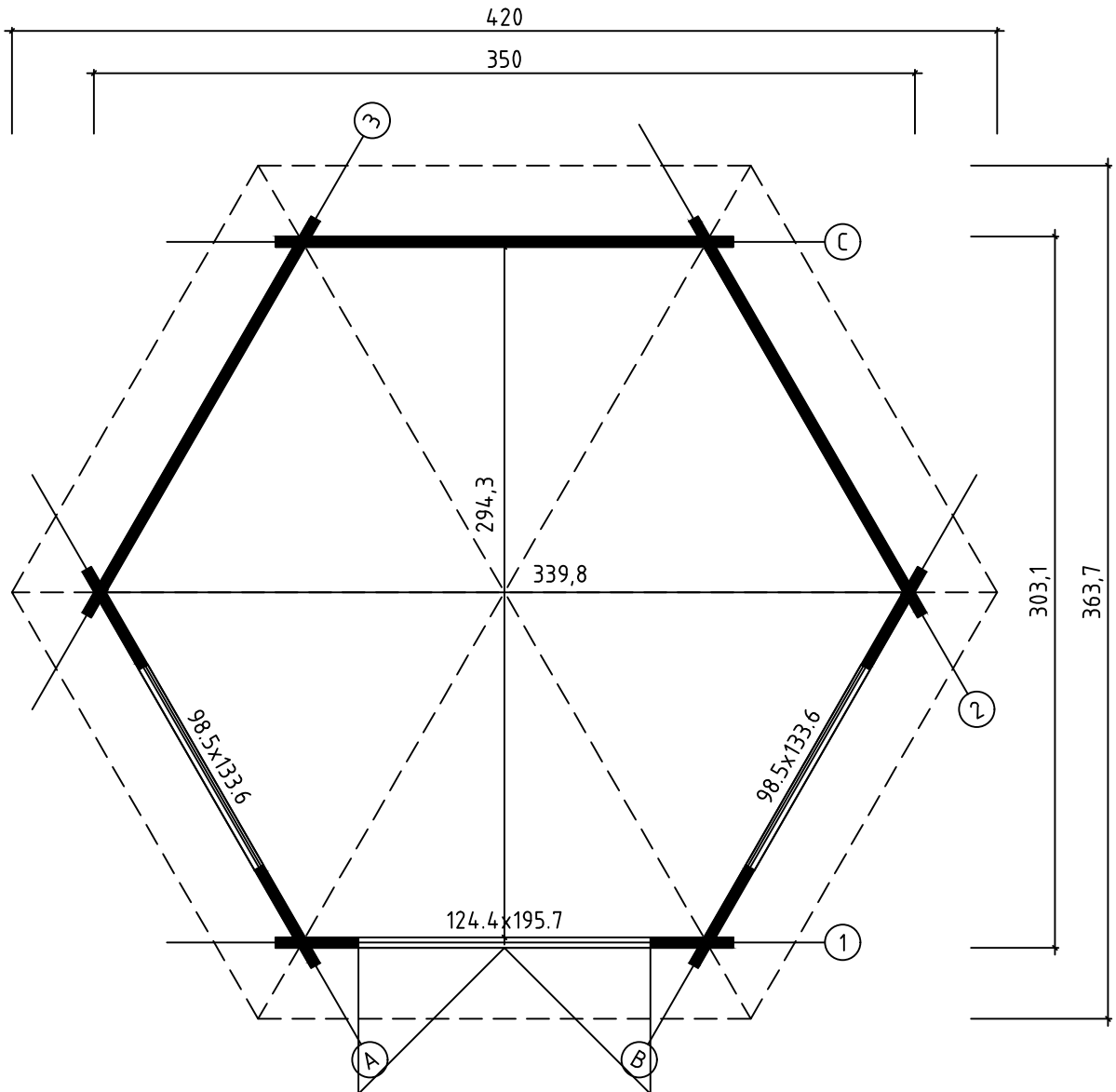



Art.Nr. 4416802

FLOOR BOARDS - FUSSBODENBRETTER - PLAN POSE PLANCHER

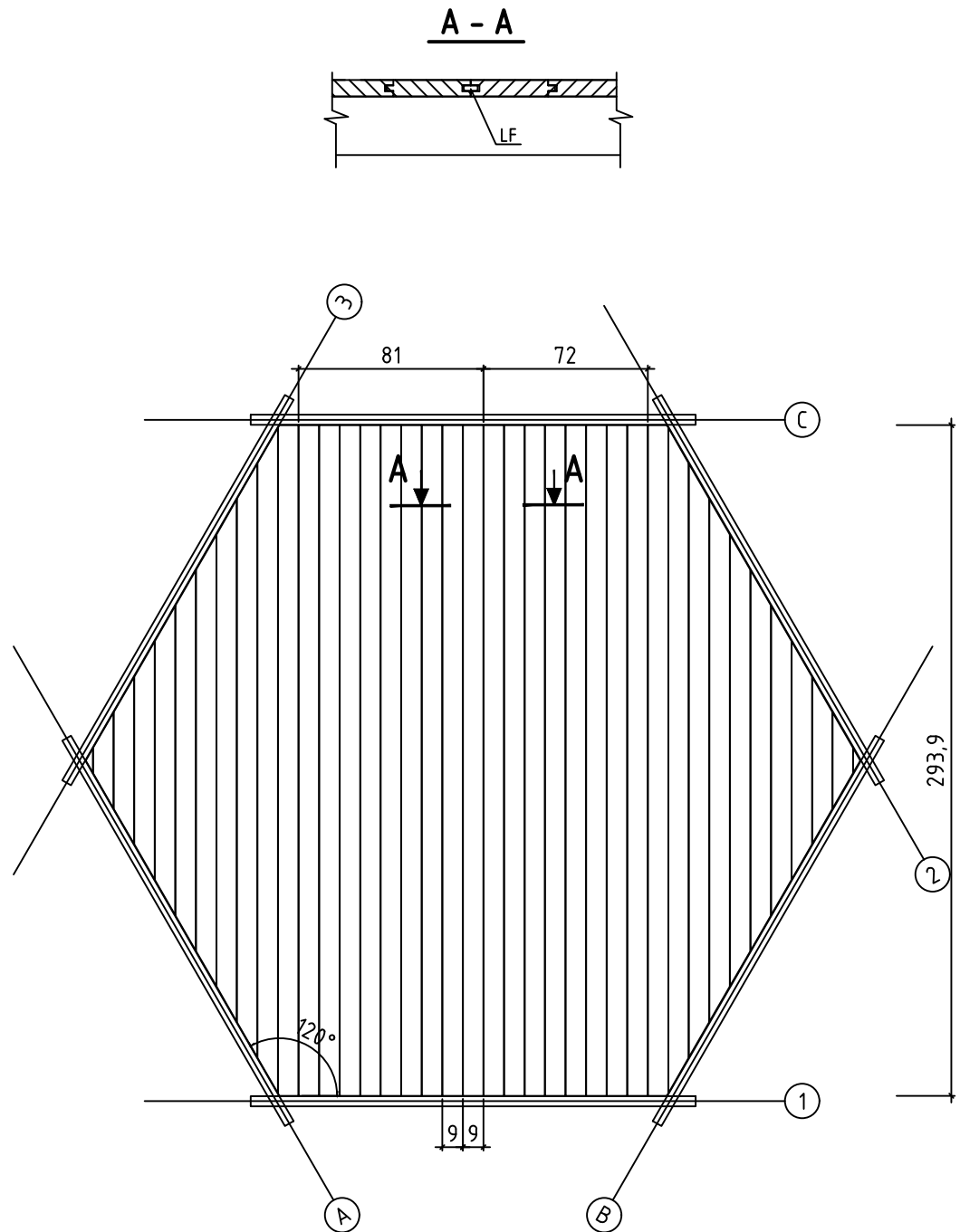



Art.Nr. 4416802

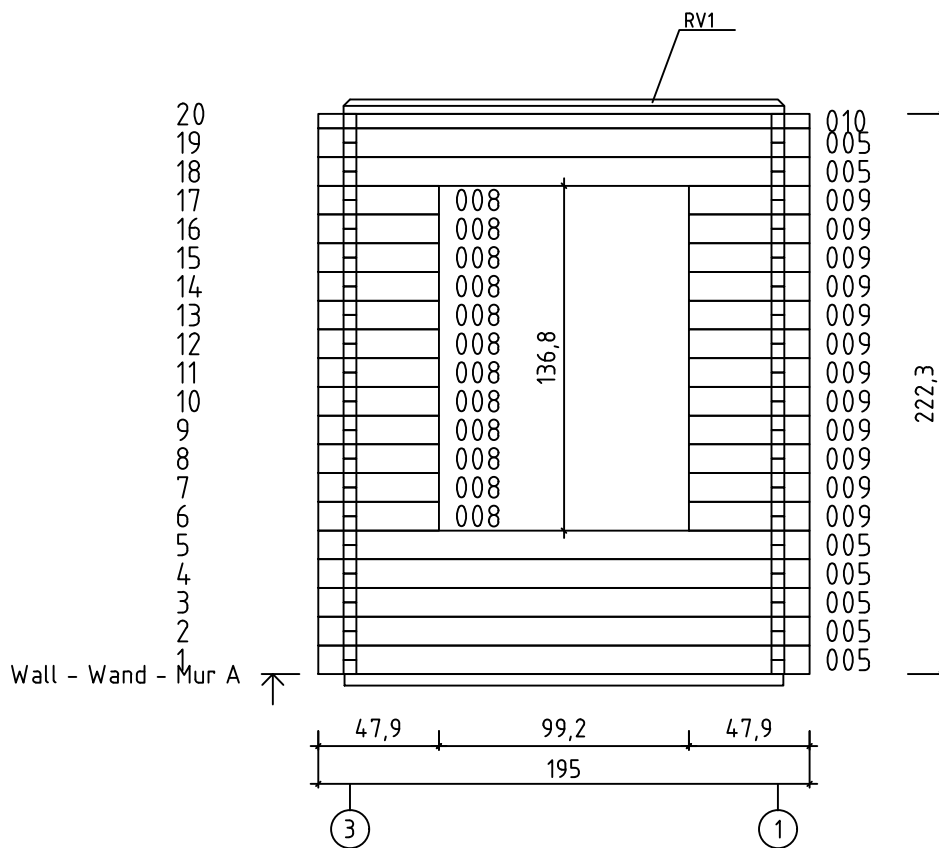
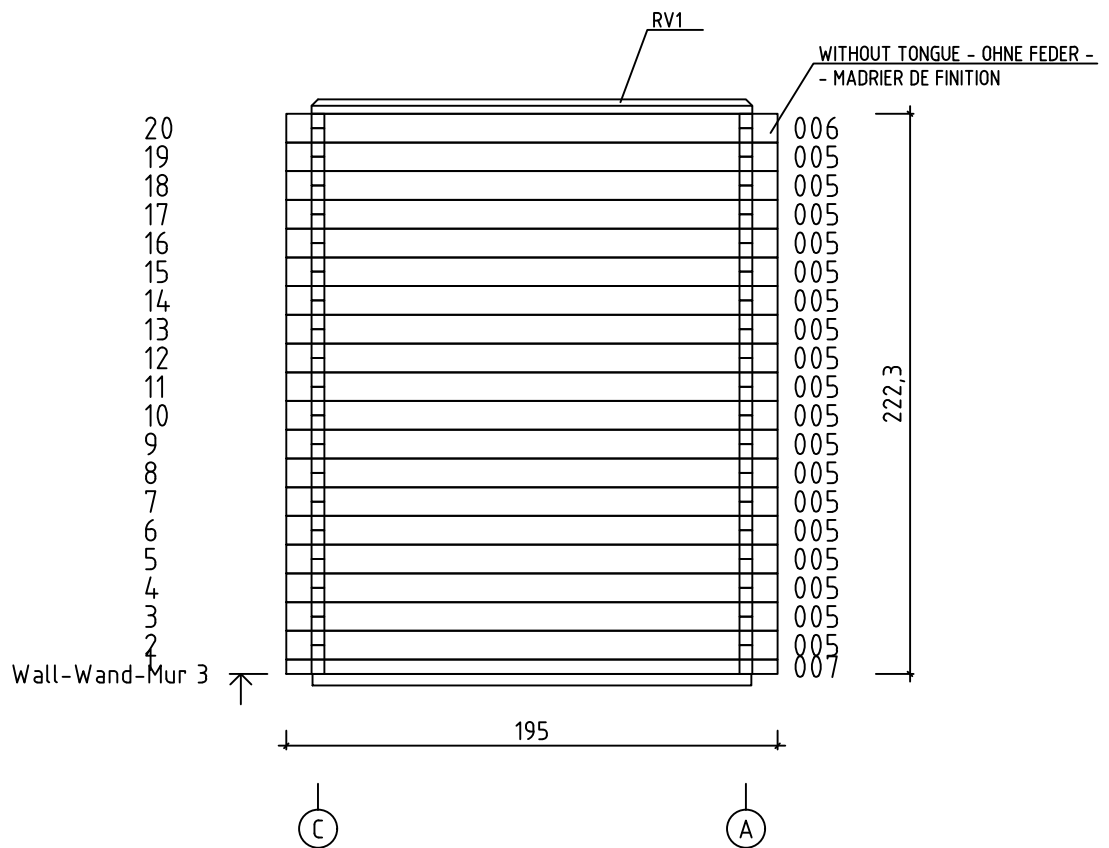

Art.Nr. 4416802

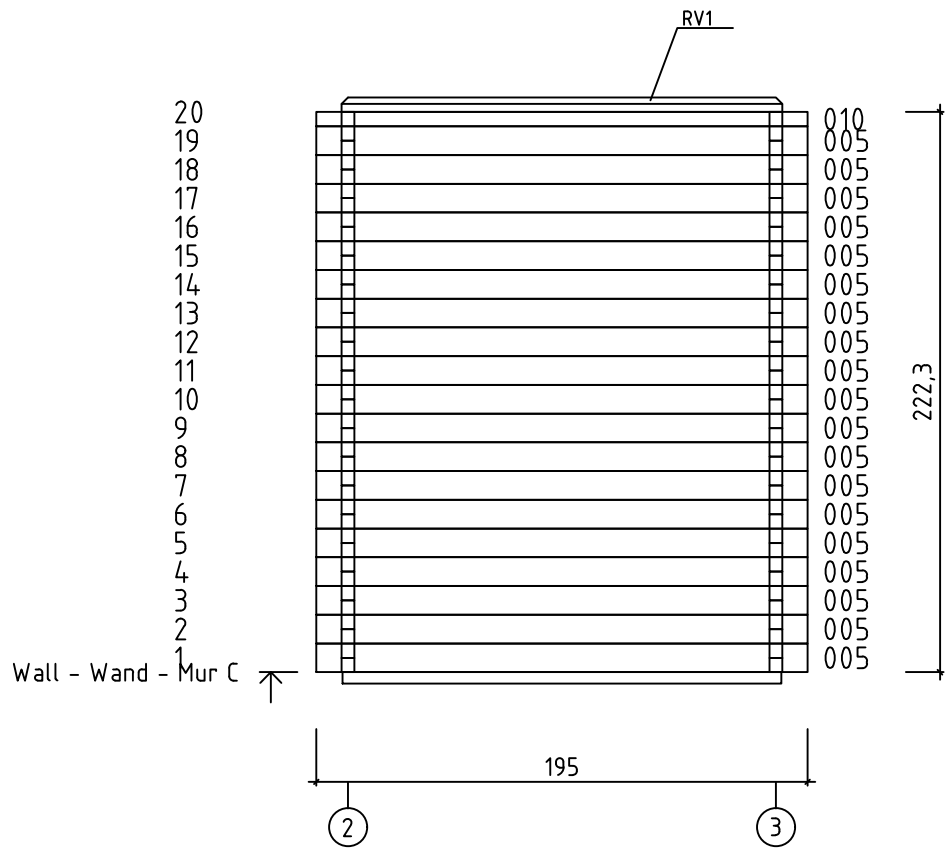
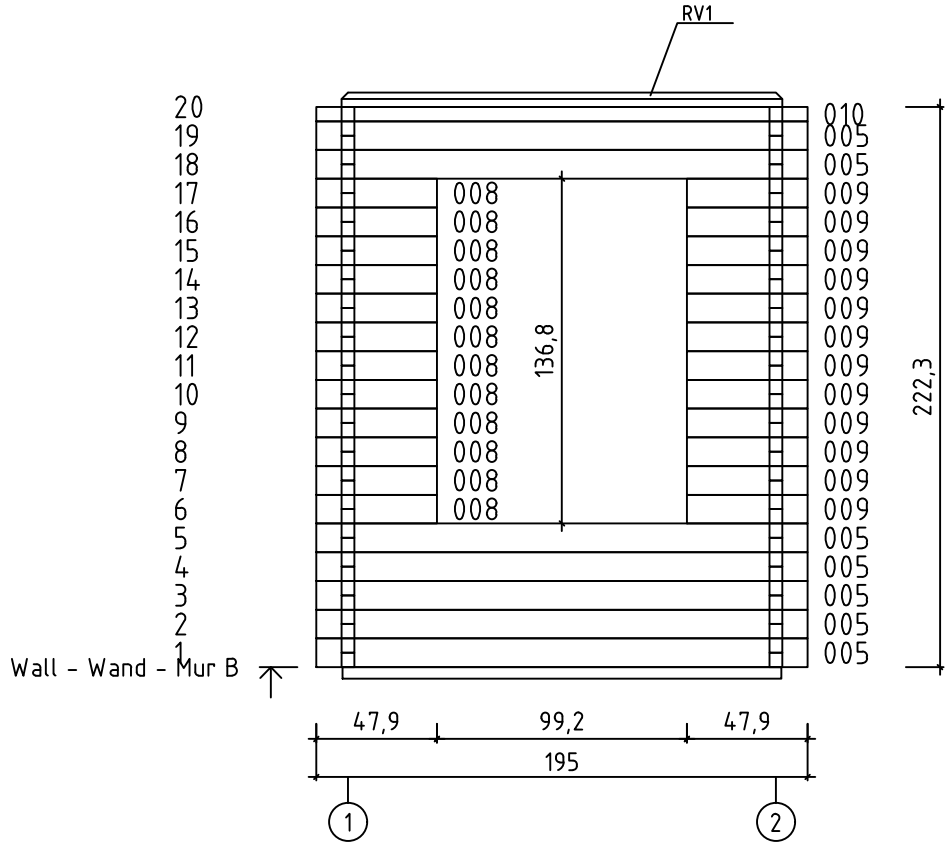

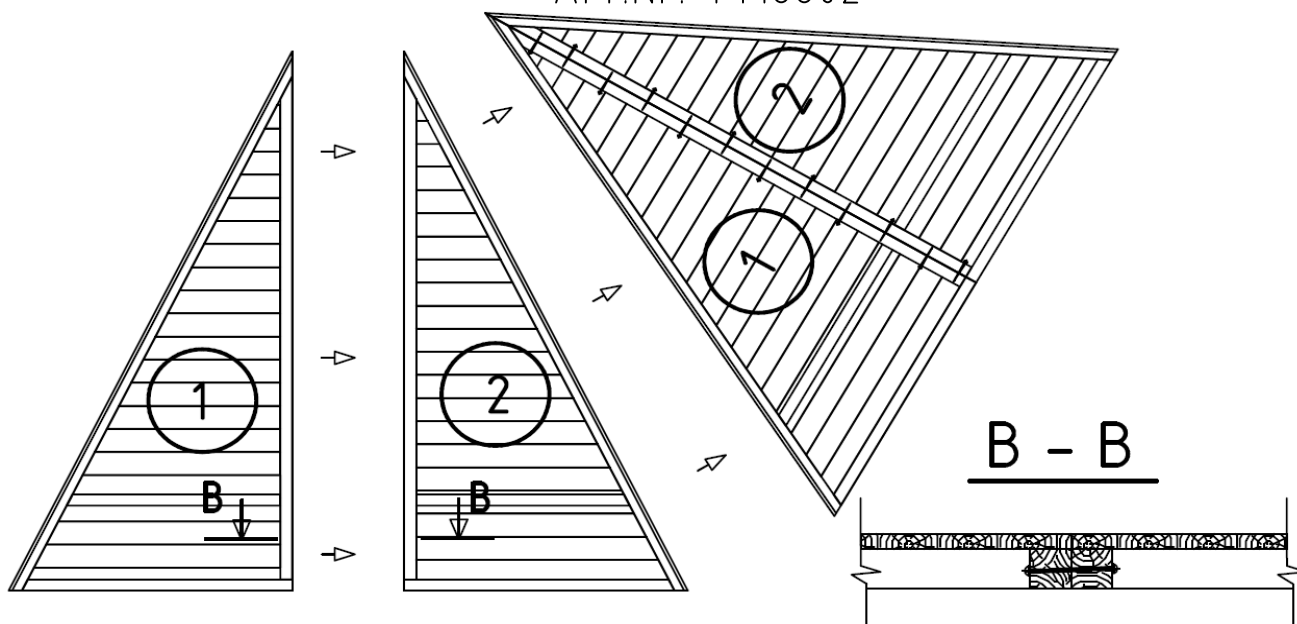

ATTACH LEFT AND RIGHT (1 & 2) ROOF PANELS TOGETHER, USING 2 SCREWS HS1 (12 PCS TOTAL) AT THE LOWEST PART (B-B). THEN AT REGULAR INTERVALS USING THE REMAINING 10 SCREWS, ATTACHING THEM ON ALTERNATING SIDES.

VERBINDEN SIE DIE LINKE UND RECHTE (1 & 2) DACHFLÄCHE MIT DEN SCHRAUBEN HS1 (12 STÜCK INSGESAMT) BEGINNEND AN DER TIEFSTEN STELLE (BB). DANN IN REGELMÄßIGEN ABSTÄNDEN DIE RESTLICHEN SCHRAUBEN VON BEIDEN SEITEN BIS HIN ZUR SPITZE ANBRINGEN.

ASSEMBLER LES PANNEAUX DE TOIT 1 ET 2 AVEC LES VIS (HS1 - 12 VIS AU TOTAL) EN LES RÉPARTISSANT À INTERVALLE RÉGULIER COMME LE MONTRE LE DESSIN CI-DESSOUS.

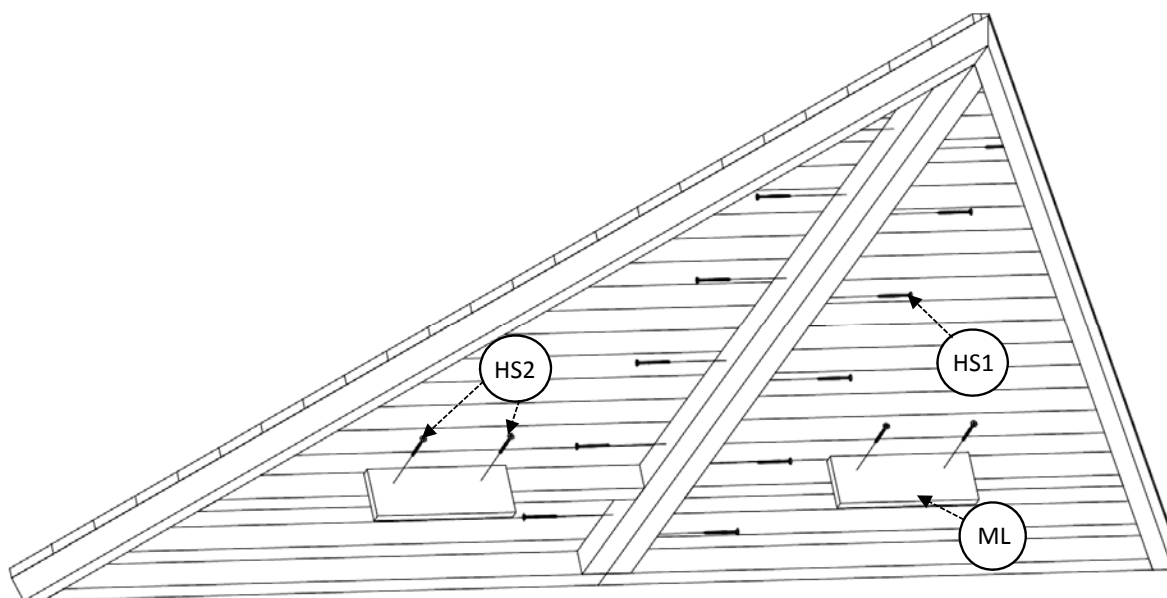

USING 2 SCREWS (HS2) ATTACH ML TO THE LOWER PART CROSS BATTEN ON THE UNDERSIDE OF THE ROOF PANEL (THESE ARE TEMPORARY SUPPORTS).

MIT DEN ZWEI SCHRAUBEN (HS2) BEFESTIGEN SIE DIE KOMPONENTE ML AUF DEM UNTEREN RAHMENTEIL. HIERBEI HANDELT ES SICH UM STÜTZEN ZUR BEFESTIGUNG DER DACHFLÄCHEN.

POUR LA MISE EN PLACE DES PANNEAUX DE TOIT, VEUILLEZ VISSER TEMPORAIREMENT LES DÉTAILS ML AUX TRAVERSES INTERMÉDIAIRES AVEC LES 2 VIS (HS2) POUR CHAQUE DÉTAIL ML. UNE FOIS LA MISE EN PLACE DE LA TOITURE TERMINÉE, VOUS POURREZ LES ENLEVER.



Art.Nr. 4416802

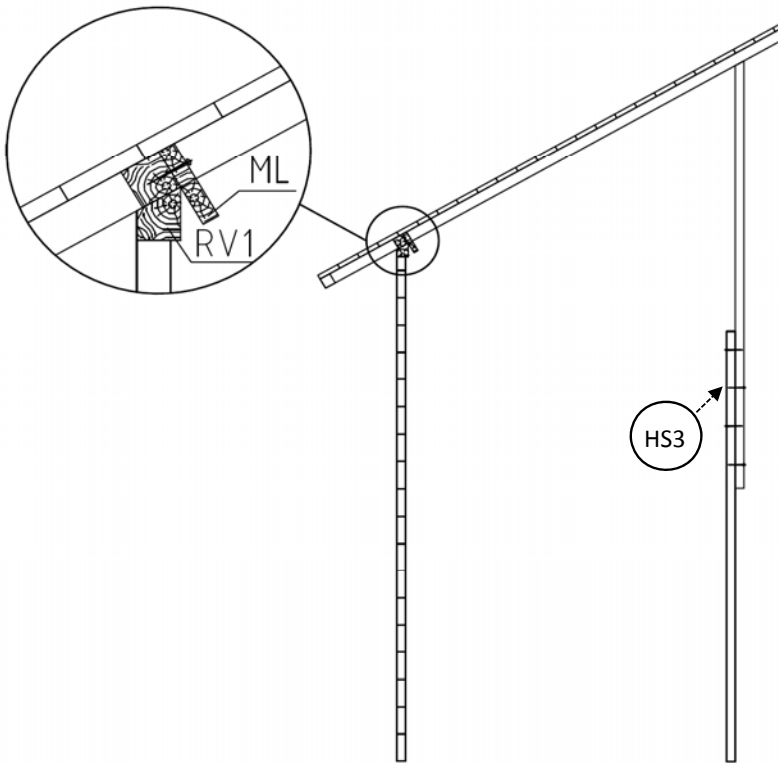

ATTACH TOGETHER PARTS AB SO THAT THE ENTIRE LENGTH IS 3100 MM USING 4 SCREWS PROVIDED HS3. THIS IS A TEMPORARY SUPPORT TO HELP YOU MOUNT THE ROOF.

VERBINDEN SIE DIE BEIDEN KOMPONENTEN A & B MITTELS DER VIER SCHRAUBEN HS3 MITEINANDER. SO DASS DIE LÄNGE 3.100 MM BETRÄGT. HIERBEI HANDELT ES SICH UM EINE TEMPORÄRE STÜTZE ZUR INSTALLATION DER DACHFLÄCHEN.

POUR LA MISE EN PLACE DES PANNEAUX DE TOIT, VEUILLEZ VISSER AVEC 4 VIS (HS3) LES SUPPORTS DE MAINTIEN DE TOIT AB ENSEMBLE DE TELLE SORTE À OBTENIR UN POTEAU D'UNE HAUTEUR TOTALE DE 3 100 MM. UNE FOIS LA MISE EN PLACE DE LA TOITURE TERMINÉE, VOUS POURREZ L'ENLEVER.

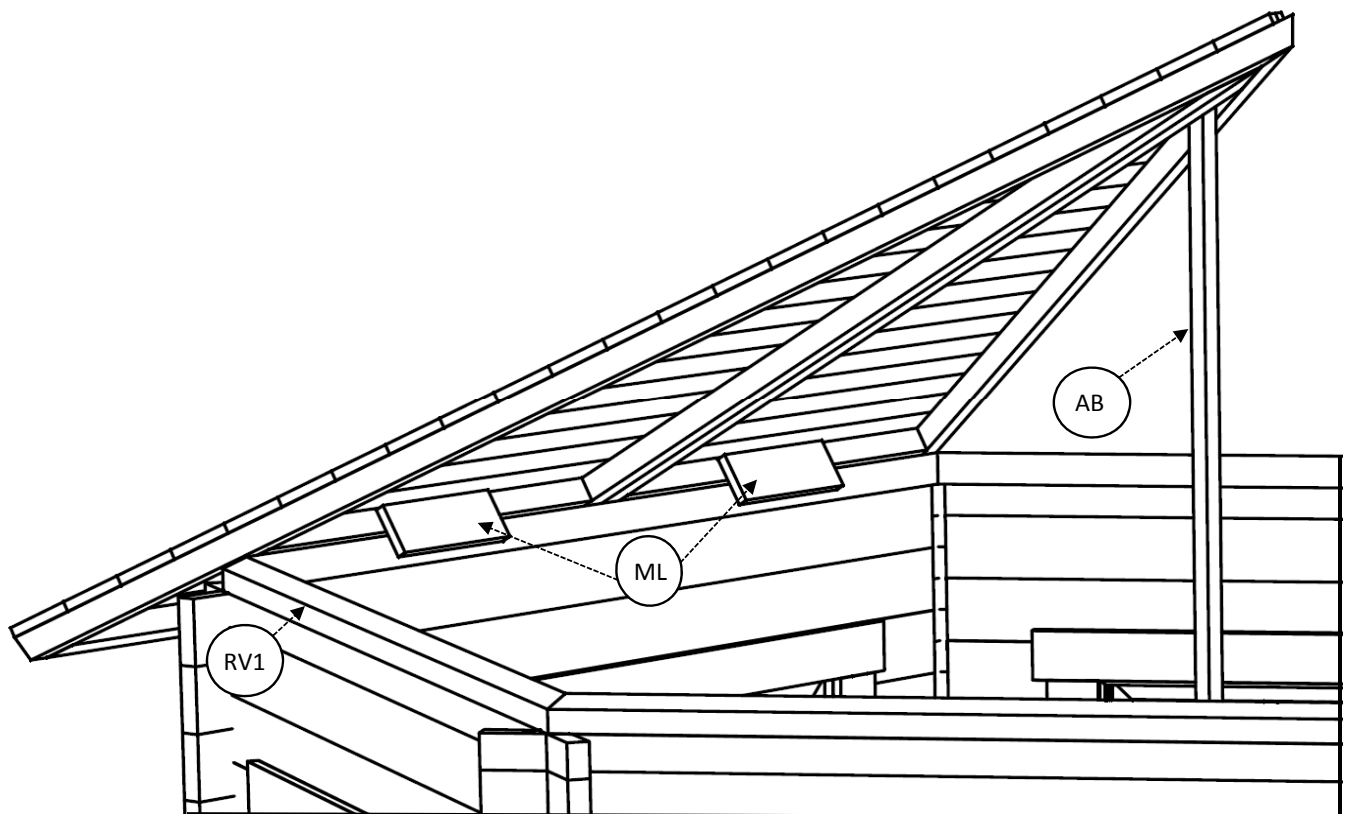



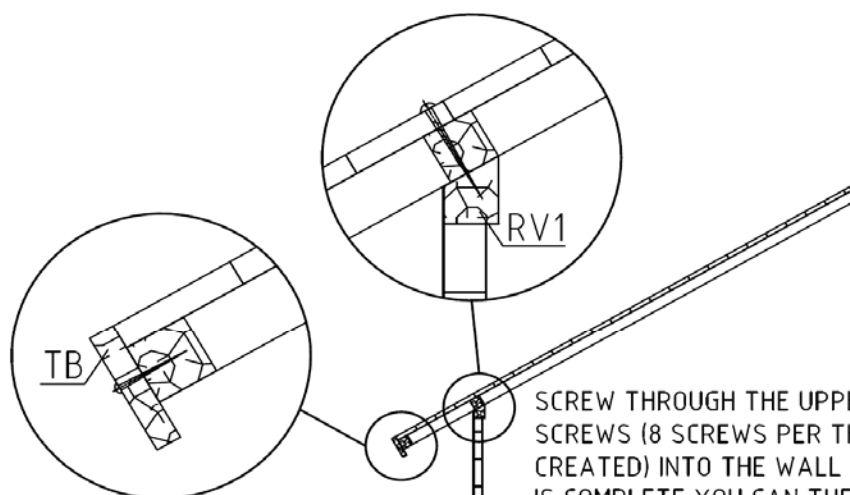

UNDER THE EAVES OF THE ROOF EDGE ATTACH THE FASCIA BOARD TB USING SCREWS PROVIDED HS5 (3 PCS).

ANSCHLIEßEND BRINGEN SIE BITTE DIE UMLAUFENDEN ABSCHLUßBRETTER (TB) MITTELS DER DREI SCHRAUBEN HS5 JEWEILS AM UNTEREN RAHMENTEIL DER DACHFLÄCHENDREIECKE AN.

FIXER LES PLANCHES DE RIVES TB AUX EXTRÉMITÉS VISIBLES DES PANNEAUX DE TOIT AVEC LES VIS HS5 (3 VIS PAR PLANCHE).

SCREW THROUGH THE UPPER PART OF THE ROOFING USING HS4 SCREWS (8 SCREWS PER THE DOUBLE PANEL SECTION YOU CREATED) INTO THE WALL SECTION UNDERNEATH (RV1). ONCE THIS IS COMPLETE YOU CAN THEN REMOVE THE TEMPORARY SUPPORTS ML AND HS3.

SCHRAUBEN SIE NUN DURCH DIE DACHELEMENTE (B/B, C/C ETC.) DIE SCHRAUBEN HS4 (8 SCHRAUBEN JE DOPPELDREIECK) IN DIE DARUNTER LIEGENDE KOMPONENTE RV1 UM DIE DACHFLÄCHEN MIT DEN WÄNDEN ZU VERBINDEN. SOBALD DIES ABGESCHLOSSEN IST, KÖNNEN DIE TEMPORÄREN STÜTZEN ML UND A/B ENTFERNT WERDEN.



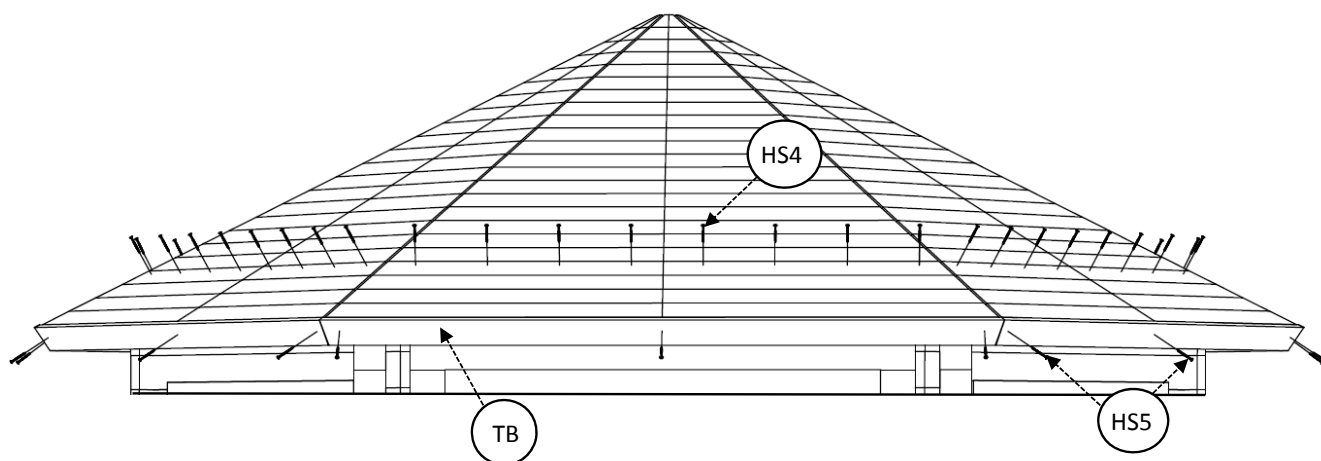











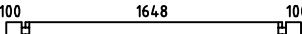
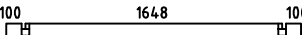
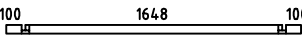

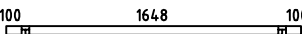
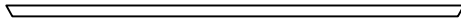
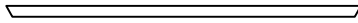
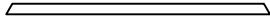
VISSER LES PANNEAUX DE TOIT EN PLACE AUX MADRIERS SUPÉRIEURS DE FINITION (RV1) EN UTILISANT LES VIS HS4 (8 VIS PAR PANNEAUX PRÉASSEMBLÉS). UNE FOIS TERMINÉE, VOUS POUVEZ ENLEVER LES SUPPORTS ML DE CHAQUE PANNEAU ET LE POTEAU DE MAINTIEN DE TOIT AB.



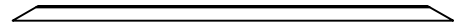
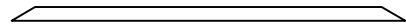

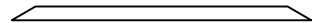
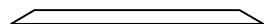

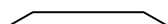



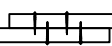

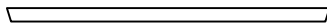
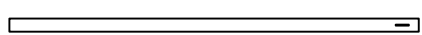
THEN YOU ARE READY TO APPLY SHINGLES OR FELT (NOT SUPPLIED).

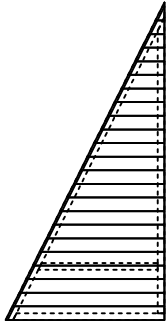
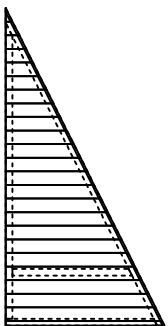
NUN KÖNNEN SIE DAMIT BEGINNEN DIE DACHEINDECKUNG ZU VERLEGEN (NICHT IM LIFERUMFANG ENTHALTEN).

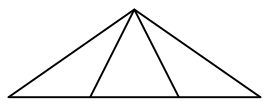
VOUS POUVEZ MAINTENANT PROCÉDER À LA MISE EN PLACE DE LA FINITION DE TOITURE (FOURNIE SÉPAREMENT EN OPTION).

| Pos  | 20.04.2016  | Piecelist - Stücklist - Liste des composants<br>Art.Nr. 4416802                       | 12/15 | Q. | P.<br>(mm) | L.<br>(mm) |
|------|---|---|-------|----|------------|------------|
| 001  |    |   |       | 1  | 44x57      | 350        |
| 002  |    |   |       | 1  | 44x57      | 350        |
| 003  |    |   |       | 17 | 44x114     | 350        |
| 004  |    |   |       | 17 | 44x114     | 350        |
| 005  |    |   |       | 70 | 44x114     | 1950       |
| 006  |    |   |       | 3  | 44x114     | 1950       |
| 007  |    |   |       | 2  | 44x57      | 1950       |
| 008  |    |   |       | 24 | 44x114     | 479        |
| 009  |    |   |       | 24 | 44x114     | 479        |
| 010  |    |   |       | 3  | 44x57      | 1950       |
| IAR3 | FOUNDATION - FUNDAMENT - FONDATION  |   |       |    |            |            |
| IAR3 |   |   |       | 2  | 70x45      | 3026       |
| IAR2 | FOUNDATION - FUNDAMENT - FONDATION  |   |       |    |            |            |
| IAR2 |  |   |       | 2  | 70x45      | 2345       |
| IAR1 | FOUNDATION - FUNDAMENT - FONDATION  |   |       |    |            |            |
| IAR1 |  |   |       | 6  | 70x45      | 1744       |
| RV1  | WALL FINISHING BOARD - ABSCHLUSSBOHLE - MADRIER SUPÉRIEUR DE FINITION               |   |       |    |            |            |
| RV1  |  |   |       | 6  | 44x57      | 1750       |
|      | FLOOR BOARDS - FUSSBODENBRETTER -<br>- LAME DE PLANCHER                             |   |       | 17 | 90x18      | 2939       |
|      | FLOOR BOARDS - FUSSBODENBRETTER -<br>- LAME DE PLANCHER                             |   |       | 2  | 90x18      | 2939       |
|      | FLOOR BOARDS - FUSSBODENBRETTER -<br>- LAME DE PLANCHER                             |   |       | 2  | 90x18      | 2916       |
|      | FLOOR BOARDS - FUSSBODENBRETTER -<br>- LAME DE PLANCHER                             |   |       | 2  | 90x18      | 2605       |
|      | FLOOR BOARDS - FUSSBODENBRETTER -<br>- LAME DE PLANCHER                             |   |       | 2  | 90x18      | 2293       |
|      | FLOOR BOARDS - FUSSBODENBRETTER -<br>- LAME DE PLANCHER                             |   |       | 2  | 90x18      | 1981       |
|      | FLOOR BOARDS - FUSSBODENBRETTER -<br>- LAME DE PLANCHER                             |   |       | 2  | 90x18      | 1669       |
|      | FLOOR BOARDS - FUSSBODENBRETTER -<br>- LAME DE PLANCHER                             |   |       | 2  | 90x18      | 1358       |
|      | FLOOR BOARDS - FUSSBODENBRETTER -<br>- LAME DE PLANCHER                             |  |       | 2  | 90x18      | 1046       |
|      | FLOOR BOARDS - FUSSBODENBRETTER -<br>- LAME DE PLANCHER                             |  |       | 2  | 90x18      | 734        |
|      | FLOOR BOARDS - FUSSBODENBRETTER -<br>- LAME DE PLANCHER                             |  |       | 2  | 90x18      | 422        |

| Pos   | 20.04.2016 | Piecelist - Stücklist - Liste des composants<br>Art.Nr. 4416802  | 13/15   | Q. | P.<br>(mm) | L.<br>(mm) |
|-------|------------|--|---|----|------------|------------|
|       |            | FLOOR BOARDS - FUSSBODENBRETTER -<br>- LAME DE PLANCHER  |    | 2  | 90x18      | 110        |
| AB    |            | ASSEMBLY BATTEN - MONTAGELATTE - BAGUETTES DE MAINTIEN,<br>NÉCESSAIRES À LA MISE EN PLACE DES PANNEAUX DE TOIT |      | 2  | 28x34      | 1800       |
| LF    |            | FITTING SLAT - LOSE FEDER - PROFIL DE JONCTION   |    | 1  | 6x15       | 2939       |
|       |            | FLOOR FILLET-FUSSBODENLEISTE - CORNIERE DE FINITION DU<br>PLANCHER   |    | 6  | 18x18      | 1720       |
| TB    |            | FASCIA BOARD - TRAUFBRETT - BANDEAU DE TOIT  |     | 6  | 18x90      | 2134       |
| KFS-1 |            | STORM PROTECTION - STURMLEISTE -<br>- LATTE ANTI-TEMPETE   |     | 6  | 22x45      | 2500       |
| ML    |            | ASSEMBLY BATTEN - MONTAGELATTE - BAGUETTES DE MAINTIEN,<br>NÉCESSAIRES À LA MISE EN PLACE DES PANNEAUX DE TOIT |    | 12 | 18x90      |            |
| 1     |            | ROOF ELEMENT (LEFT) - DACHELEMENT (LINKE) - PANNEAU DE TOIT PRÉMONTÉ   |   | 6  | 62x1050    | 2100       |
| 2     |            | ROOF ELEMENT (RIGHT) - DACHELEMENT (RECHTE) - PANNEAU DE TOIT PRÉMONTÉ   |  | 6  | 62x1050    | 2100       |
| FS2   |            | WINDOW HANDLE FITTINGS - FENSTERGRIFF - POIGNÉE D'OUVERTURE<br>DE FENETRE                                      |  | 2  | FG10.AL    |            |
|       |            | SCREW FOR ROOF CAP - SCHRAUBEN FÜR DACHKAPPE -<br>- VIS DE FIXATION DU CHAPEAU DE TOIT                         |  | 3  | 4.8x28     |            |
|       |            | ROOF CAP - DACHKAPPE - CHAPEAU DE TOIT   |   | 1  |            |            |
| HS1   |            | SCREW FOR GEORGIAN BARS - SCHRAUBE FÜR SPROSSEN - VIS POUR<br>FIXATION CROISILLONS BOIS DES MENUISERIES        |  | 60 | 2.5x20     |            |
| HS4   |            | SCREW FOR WINDOW FILLET - SCHRAUBE FÜR GLASLEISTE - VIS DE<br>FILET DE FENETRE                                 |  | 6  | 3x30       |            |
| HS4   |            | SCREW FOR DOOR FILLET - SCHRAUBE ZUR BEFESTIGUNG TÜRLEISTE -<br>VIS POUR FIXATION BAGUETTE D'ARRET DE PORTE    |  | 5  | 3x30       |            |

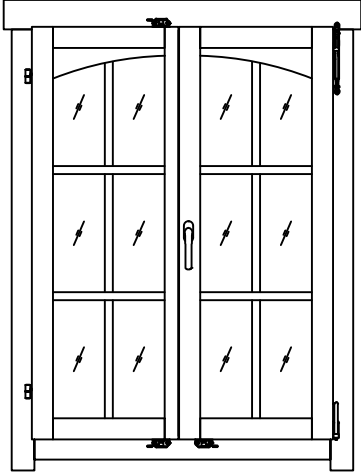
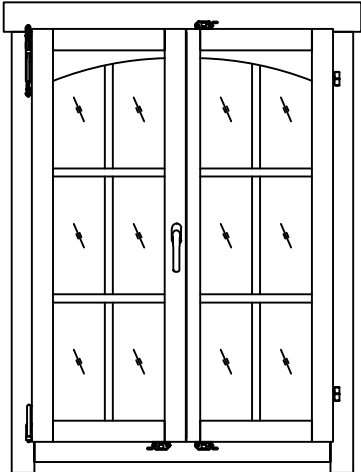
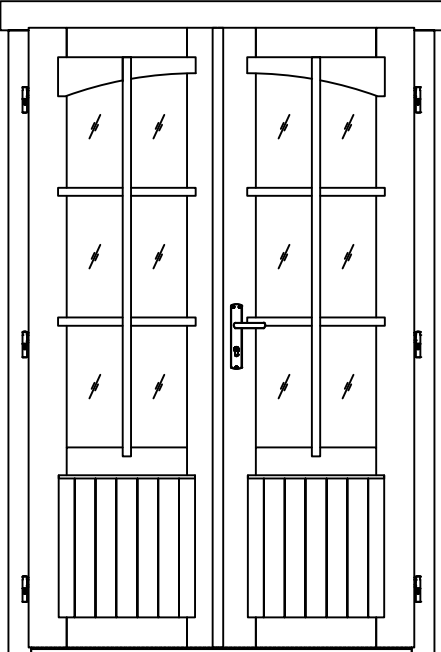

| Pos | 20.04.2016<br>Piecelist - Stücklist - Liste des composants<br>Art.Nr. 4416802  | 15/15 | Q. | P.<br>(mm) | L.<br>(mm) |
|-----|--|-------|----|------------|------------|
|     | <p data-bbox="240 147 855 181">WINDOW - FENSTER - FENETRE 985x1336 DGP+A+</p> <p data-bbox="1038 147 1251 181">TAK.1.106.PSP.Kf</p>   | 1     |    |            |            |
|     | <p data-bbox="240 730 855 763">WINDOW - FENSTER - FENETRE 985x1336 DGP+A+</p> <p data-bbox="1038 730 1251 763">TAK.1.106.PSV.Kf</p>  | 1     |    |            |            |
|     | <p data-bbox="240 1312 746 1346">DOOR - TÜR - PORTE 1244x1957 DGP+A+</p> <p data-bbox="962 1312 1241 1346">TUK.2.066.PVP.MMKWb</p>  | 1     |    |            |            |
|     |  |       |    |            |            |
|     |  |       |    |            |            |