

Dorset 44  
Art. Nr. 4424502  
1/7



15.01.2019

Art. Nr. 4424502

Groundplan - Grundplan - Plan de masse - Planimetria - Plattegrond -  
Põhiplaan

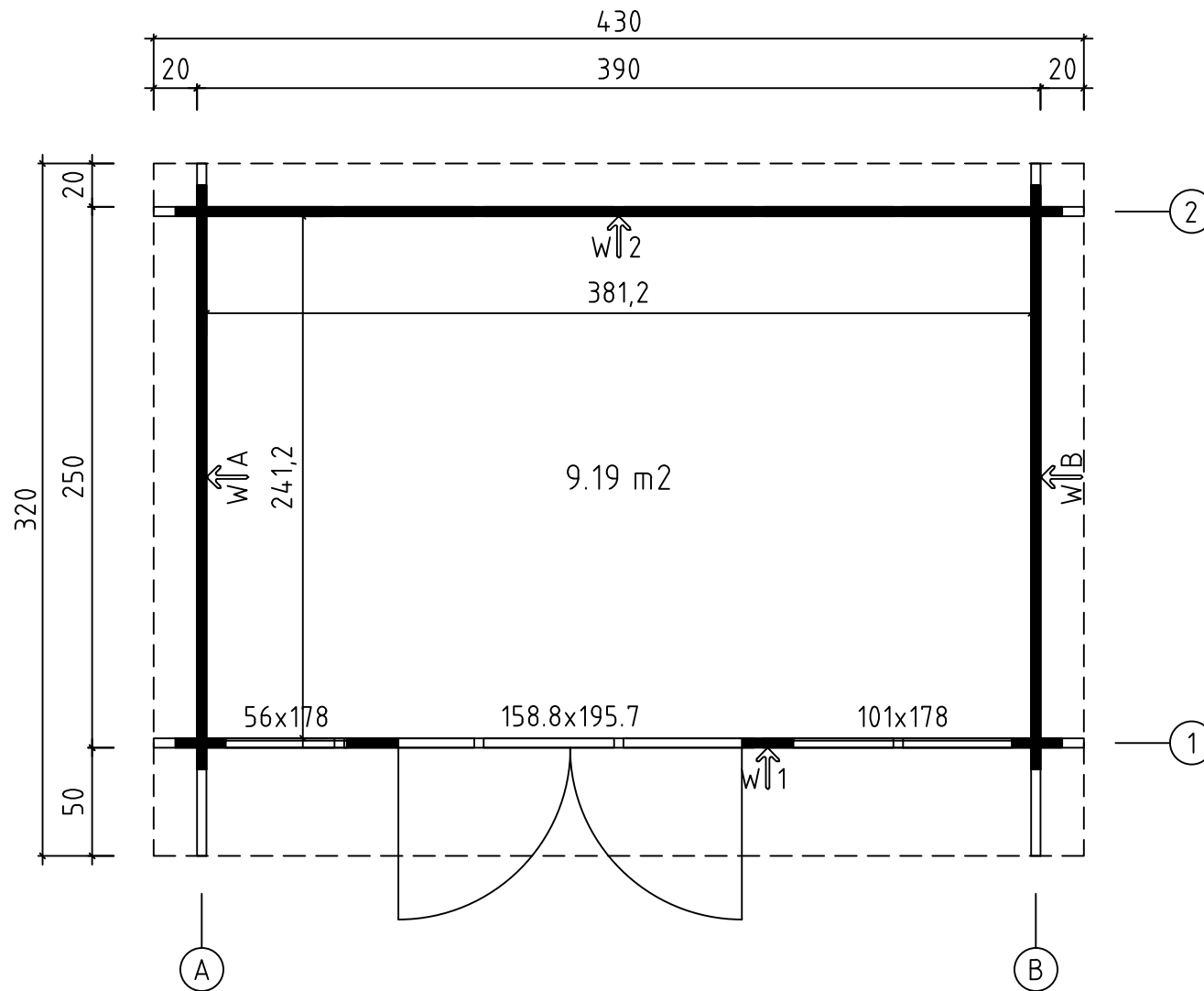

Foundation - Fundament - Fondation - Fondamenta - Fundering - Immutatut  
alusraam

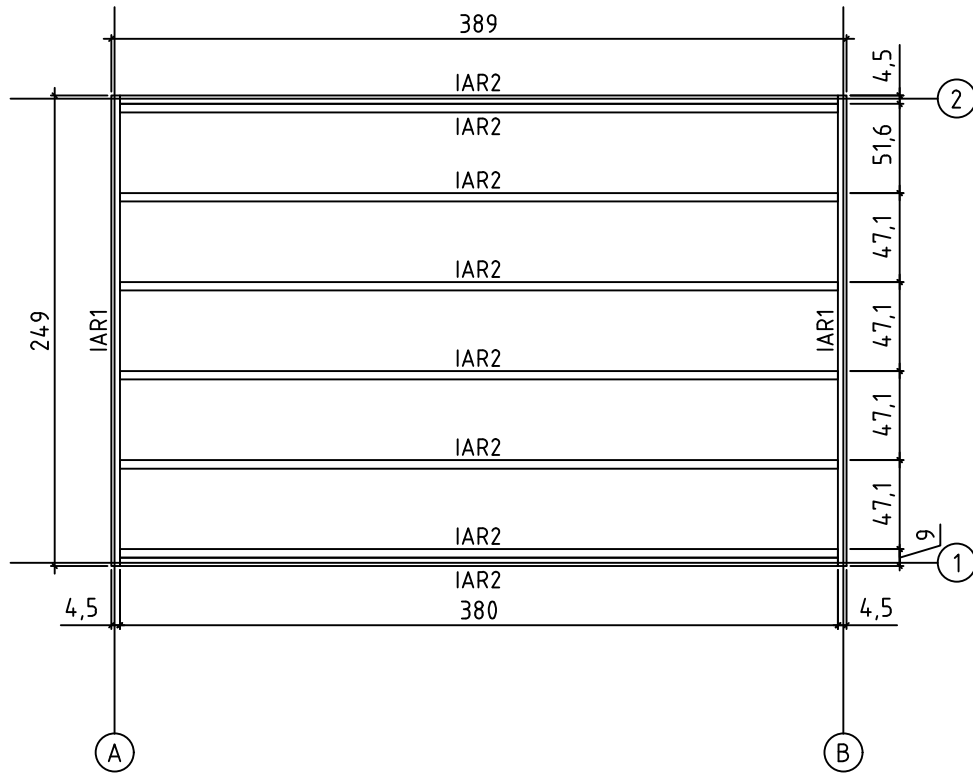



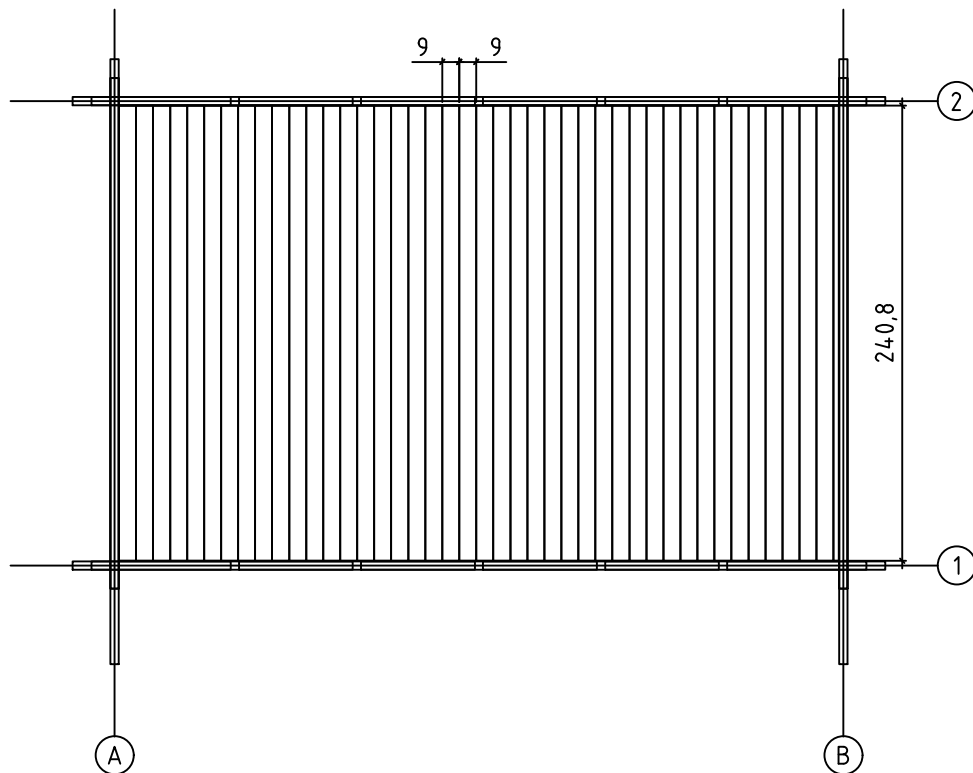

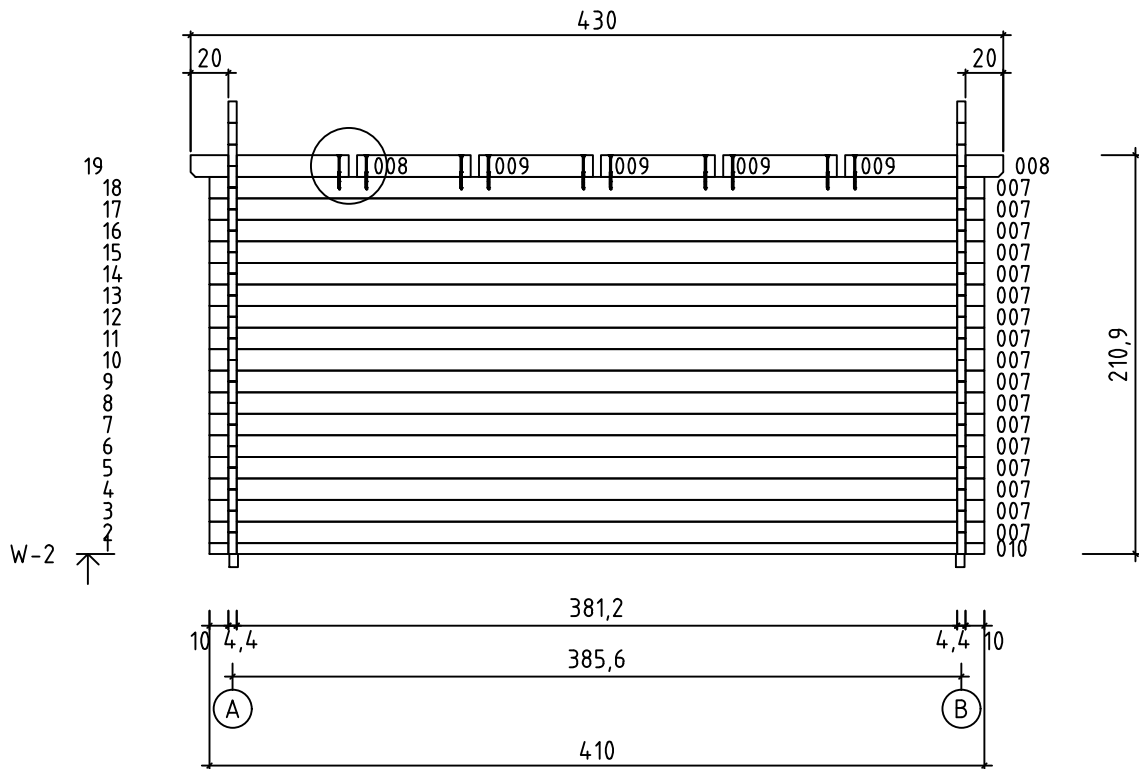
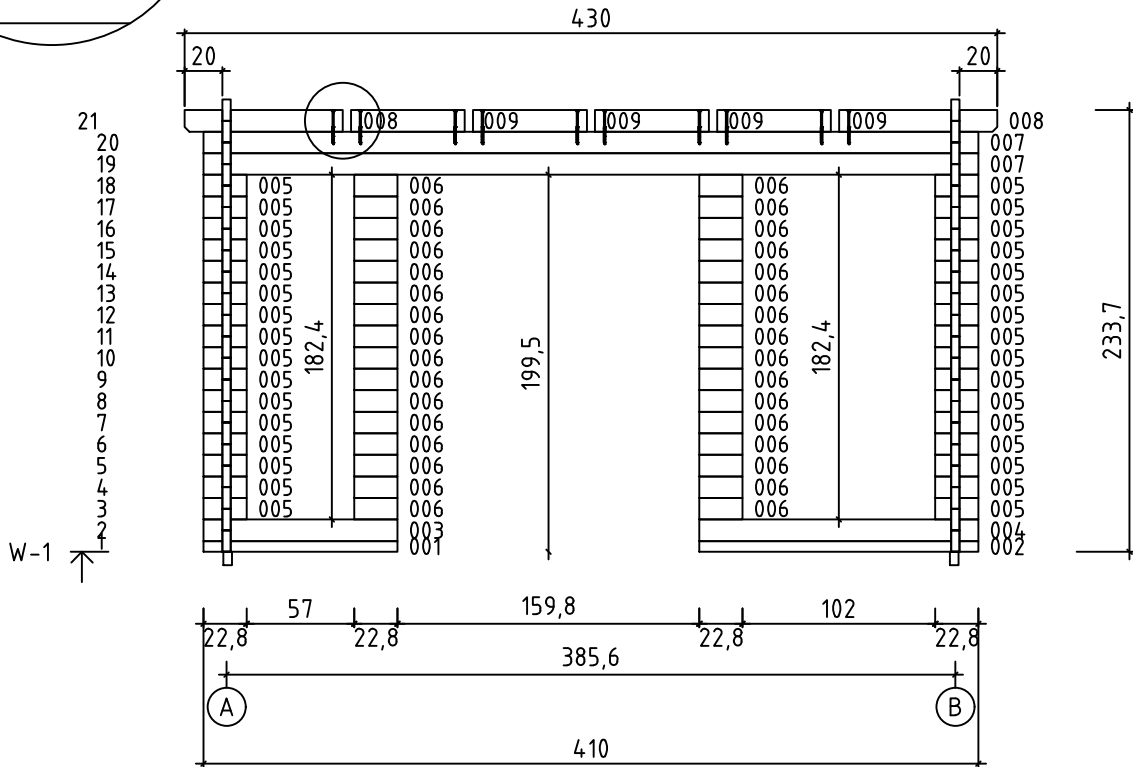
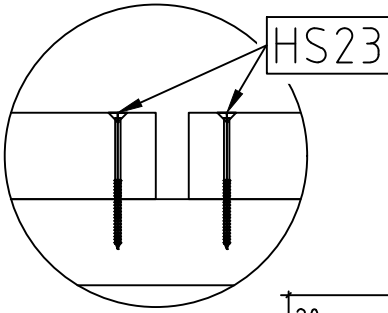

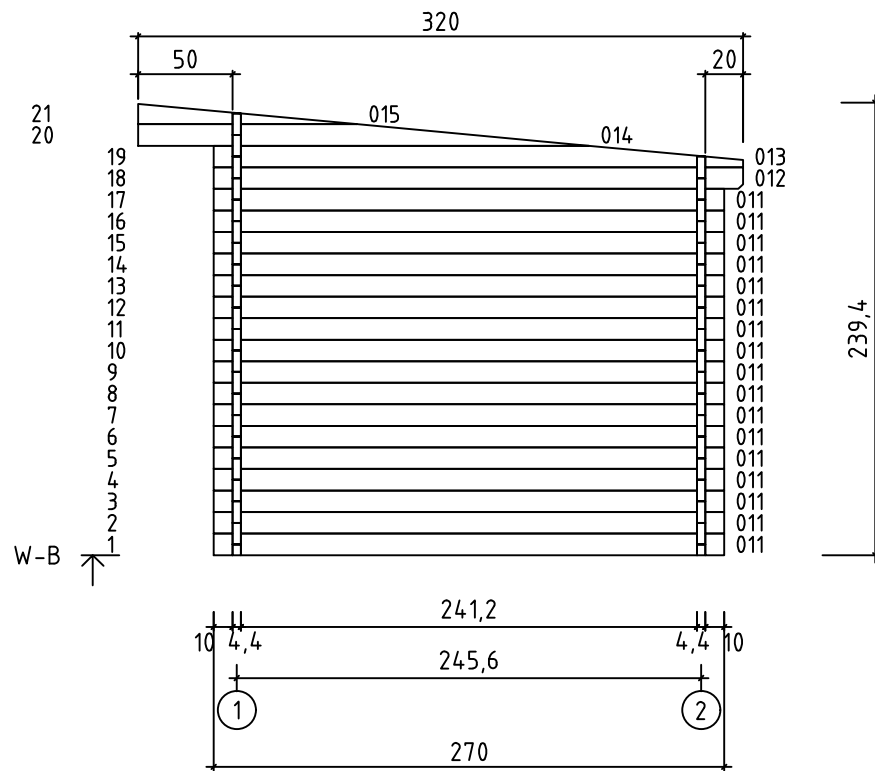
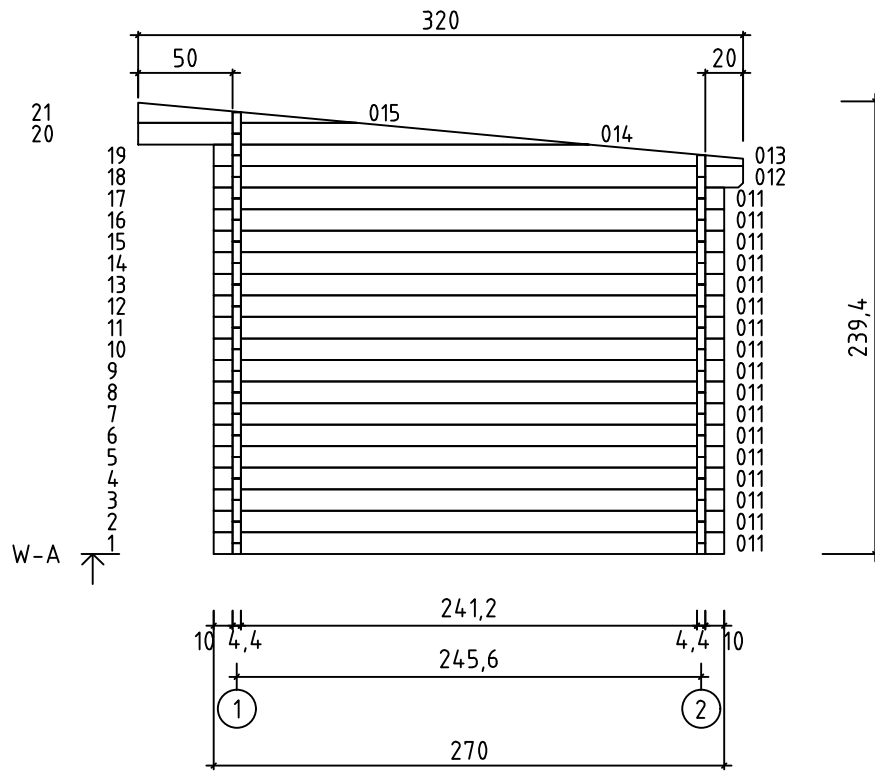

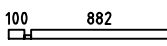
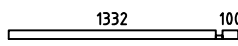
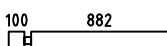
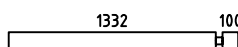

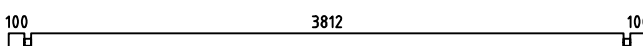
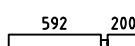
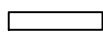
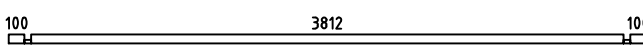
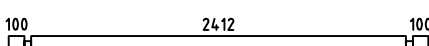
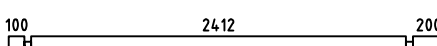
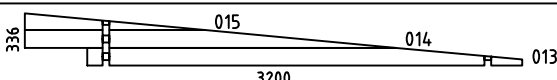
Floor boards - Fussbodenbretter - Plan pose plancher - Pavimento -  
Vloerhout - Põrandalaudis

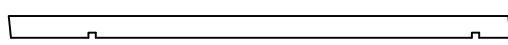
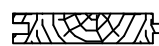





Pos	15.01.2019 Piece list - Stückliste - Liste des pièces - Elementi - Stuklijst - Tükitalabel Art. Nr. 4424502	6/7	Q	P (mm)	L (mm)
001			1	44x57	1026
002			1	44x57	1476
003			1	44x114	1026
004			1	44x114	1476
005			32	44x114	228
006			32	44x114	228
007			19	44x114	4100
008			4	44x114	836
009			8	44x114	602
010			1	44x57	4100
011			34	44x114	2700
012			2	44x114	2800
WA-1 WB-1			1 1		
IAR2	Foundation - Fundament - Fondation - Fondamenta - Fundering - Immutatud alusraam 		8	45x70	3800
IAR1	Foundation - Fundament - Fondation - Fondamenta - Fundering - Immutatud alusraam 		2	45x70	2490
SR1	Rafter - Dachsparren - Chevron - Trave - Dak spar - Sarikas 		5	44x140	3227
	Floor boards - Fussbodenbretter - Lame de plancher - Pavimento - Vloerhout - Põrandalaud 		43	90x18	2408
	Roof boards - Dachbretter - Voliges - Perlina per tetto - Dakhout - Katuselaud 		36	90x18	4300
	Floor fillet - Fussbodenteiste - Corniere de finition du plancher - Finitura per pavimento (battisco pa) - Vloerafwerklijst - Põrandaliist 			18x18	12.43
	Roofing felt fillet - Dachpappenleiste - Baguette de fixation du feutre bitumeux - Asse per fissaggio guaina bituminosa - Afdekljst asfaltpapier - Katusepapiiist 		2	18x58	3250
	Roofing felt fillet - Dachpappenleiste - Baguette de fixation du feutre bitumeux - Asse per fissaggio guaina bituminosa - Afdekljst asfaltpapier - Katusepapiiist 		1	18x58	4220
	Fascia board - Traufbrett - Bandeau de toit - Finitura lati tetto - Gevelljst - Räästalaud 		3	18x120	4336
DRV-1	Roof edge reinforcement - Dachrandverstärkung - Corniere de renfort de bord de toit - Rinforzo x tetto - Dakrand versterking - Räästatugevdus 		2	28x34	200

Pos	15.01.2019	Piece list - Stückliste - Liste des pièces - Elementi - Stuklijst - Tükitalabel	7/7	Q	P (mm)	L (mm)
DRV-2	Roof edge reinforcement - Dachrandverstärkung - Corniere de renfort de bord de toit - Rinforzo x tetto - Dakrand versterking - Räästatugevdus			2	28x34	500
DRV-3	Roof edge reinforcement - Dachrandverstärkung - Corniere de renfort de bord de toit - Rinforzo x tetto - Dakrand versterking - Räästatugevdus			2	28x34	2420
KFS-1	Storm protection - Sturmleiste - Latte anti-tempete - Protezione anti vento - Stormverankering / beveliging - Tormikinnitusliist 			2	22x45	2050
KFS-2	Storm protection - Sturmleiste - Latte anti-tempete - Protezione anti vento - Stormverankering / beveliging - Tormikinnitusliist 			2	22x45	2500
	Gable moulding - Giebelleiste - Planche de rive - Finitura per frontale e retro del tetto - Gevellijst - Viilulaud 			2	18x120	3225
HS9	Screw for gable moulding - Schrauben für giebelleiste - Vis pour fixation planche de rive - Vite per fissare finiture davanti e dietro del tetto - Schroef voor gevellijst - Kruvi viilulauale 			16	3.5x50	
HS12	Screw for fascia boards - Schrauben für traufbretter - Vis pour fixation bandeau de toit - Viti x striscia del tetto - Schroef voor gevellijst - Kruvi räästalauale 			45	4x40	
HS12	Screw for roof edge reinforcement - Schrauben für dachrandverstärkung - Vis pour fixation corniere renfort de bord de toit - Viti x rinforzo bordo tetto - Schroef voor dakrand versterking - Kruvi räästatugevdusele 			20	4x40	
HS18	Screw for rafter - Schrauben für dachsparren - Vis pour chevron - Vite per trave - Schroef voor dakspar - Kruvi sarikatele 			10	5x120	
HS18	Screw for gable - Schrauben für giebel - Vis pour fixation des pignons - Viti per timpano - Schroef voor gevelpunt - Kruvi viilude kinnitamiseks 			16	5x120	
HS16	Screw for 1. wall beam - Schraube für 1. bohlenreihe - Vis de fixations 1ere rangée de madriers avec poutrelles de fondations - Vite fissaggio alle fondamenta - Schroef voor 1 wandbalk - Kruvi pooltauale 			7	5x90	
HS16	Screw for foundation - Schrauben zur befestigung fundament - Vis de fixations des poutrelles de fondations - Viti x fondamenta - Schroef voor fundering - Kruvi alusraamile 			24	5x90	
HS23	Screw for wall details - Schraube für wand details - Vis pour mur details - Viti per elementi della porta - Schroef voor wand details - Kruvi seinadetailidele 			24	6x180	
NF2	Zn nail for floor fillet - Zn nägel für fussbodenleiste - Pointe pour corniere de finition du plancher - Chiodi x fissaggio pavimento - Spijker(nagel) voor vloer afdekljst - Nael põrandaliistule 			25	1.4x40	
SH44	Hammer block - Schlagholz - Calle de frappe - Blocco di legno da usare come cuscinetto quando si usa il martello - Slagklos - Löögiklots 			1		
SFS	Nut for storm protection - Schraubenmutter für sturmleiste - Ecrou pour latte anti-tempete - Dado x asta protezione vento - Moer voor stormverankering - Mutter tormikinnitusliistule 			8	D8	
NF4	Zn nail for roof - Zn nägel für dachbretter - Pointe pour fixation voliges de toit - Chiodi x perline tetto - Spijker(nagel) voor dakhout - Nael katusetauale 			271	2x50	
NF4	Zn nail for floor - Zn nägel für fussbodenbretter - Clous pour plancher - Chiodi x perline pavimento - Spijker(nagel) voor vloer - Nael põrandalauale 			264	2x50	
NF5	Zn nail for roofing felt fillet - Zn nägel für dachpappenleiste - Pointe pour baguette de fixation feutre bitumeux - Chiodi x carta bituminosa x tetto - Spijker(nagel) voor asfaltpapier afdekljst - Papiliistunael 			26	2x40	
BFS	Bolt for storm protection - Bolzen für sturmleiste - Boulon pour latte anti-tempete - Bullone x asta protezione vento - Bout voor stormankerlat - Puidupolt tormikinnitusliistule 			8	8x80	
DFS	Washer for storm protection - Dichtscheibe für sturmleiste - Rondelle pour latte anti-tempete - Rondella x asta protezione vento - Afdichtring voor storm strip - Seib tormikinnitusliistule 			8	D8	
	Window - Fenster - Fenetre - Finestra - Raam - Aken	560x1780 AK.1.100.TPSP DGP+		1		
	Window - Fenster - Fenetre - Finestra - Raam - Aken	1010x1780 TAK.1.100.TPM0.e DGP+		1		
	Door - Tür - Porte - Porte - Deur - Uks	1588x1957 TUK.1.100.TPVP.MM DGP+		1		

Pos	10.11.2017	Piece list - Stückliste - Liste des pièces - Elementi - Stuklijst - Tükítabel 560x1780 AK.1.100.TPSP DGP+	1/1	Q	P (mm)	L (mm)
-----	------------	--	-----	---	-----------	-----------

Glass size - Glasgröße - Taille de la vitre - Misura del vetro - Glas afmeting - Klaasi mõõt: 390x1602 mm

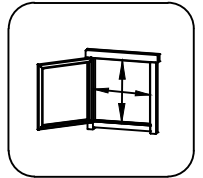
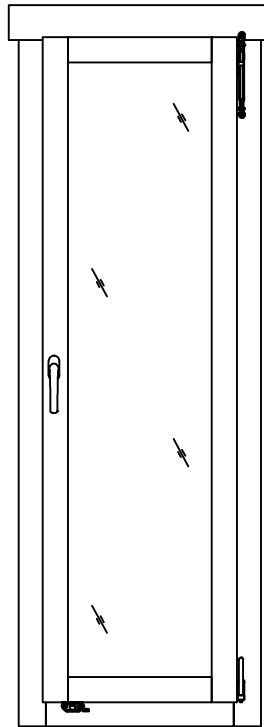

460x1684 mm







FS2	Window handle fittings - Fenstergriff - Poignee de fenetre - Maniglia c/ferramenta - Raamhendel -/grendel -/klink - Aknalink		1		
-----	---	---	---	--	--

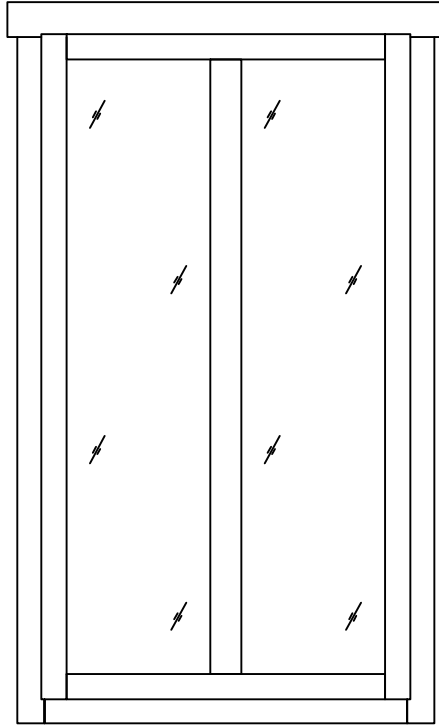

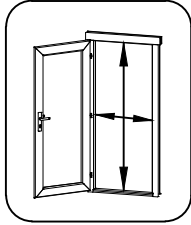
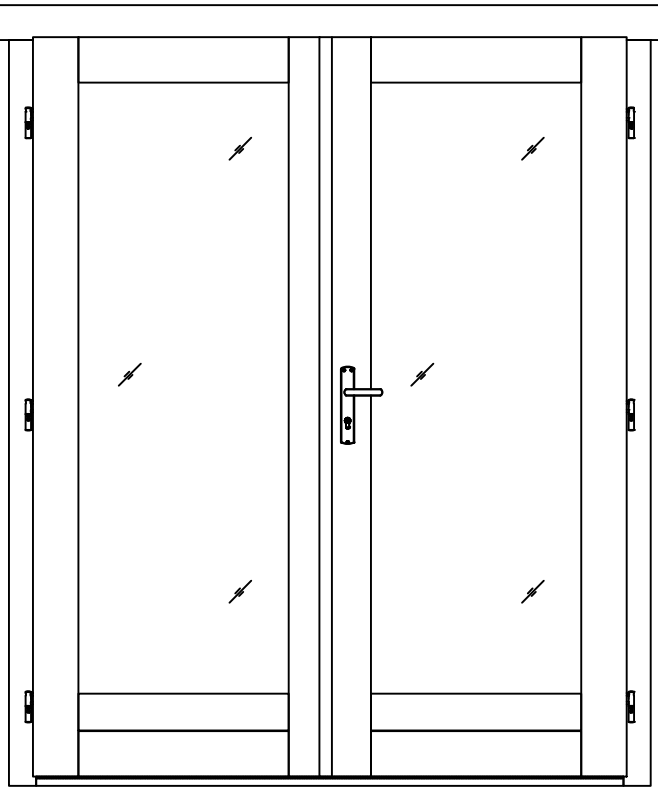
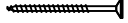
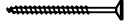
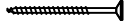
Pos	10.11.2017	Piece list - Stückliste - Liste des pièces - Elementi - Stuklijst - Tükítabel 1010x1780 TAK.1.100.TPM0.e DGP+	1/1	Q	P (mm)	L (mm)
-----	------------	--	-----	---	-----------	-----------

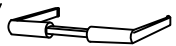
Glass size - Glasgröße - Taille de la vitre - Misura del vetro - Glas afmeting - Klaasi mõõt: 390x1602 mm

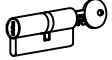

Pos	Piece list - Stückliste - Liste des pièces - Elementi - Stuklijst - Tükítabel 1588x1957 TUK.1.100.TPVP.MM DGP+	1/1	Q	P (mm)	L (mm)
	Glass size - Glasgröße - Taille de la vitre - Misura del vetro - Glas afmeting - Klaasi mõõt: 561x1593 mm			 1488x1873 mm	
					
HS4	Screw for door fillet - Schraube zur Befestigung türleiste - Vis pour fixation baguette d'arret de porte - Viti per massellino della porta - Schroef voor deurlijst - Kruvi ukse kokkuvaltšiliistule		5	3x30	
HS16	Screw for door jamb - Schraube für Türrahmen - Vis de fixation partie haute avec montants du cadre de porte - Viti x fissaggio montanti porte - Schroef voor deurkozijn - Kruvi ukse lengile		4	5x90	
HS25	Screw for doorstep - Schrauben für swelle - Vis pour fixation barre de seuil - Vite per soglia della porta - Schroef voor deurdorpel - Kruvi lävepakule		3	4.5x65	
MH	Male bolt hinge for door - Türband - Partie male de paumelle de porte - Cerniera anube x porta - Scharnier bout - Reguleeritav polthing isane		6	14x80	
HC	Covers for door hinges - Schutzkappe für Türband - Couverture de paumelle de porte - Copertura delle cerniere della porta - Afdek kap voor deurscharnier - Reguleeritava polthinge kate		12		
TL4	Door handle fittings - Türgriff - Poignée de porte - Maniglie - Deurhendel / klink - Ukse käepide		1		
TL5	Set of door lock covers - Schlossblenden - Set de garnitures de porte - Copertura serrature - Slot sluitplaat set - Ukse lukuplaat		1		
	Cylinder lock - Zylinderschloss - Barillet de porte - Serratura - Cylinder slot - Ukse lukusüdamik		1	30x35	
	Striker for barrel bolt - Hülse für Grendelriegel - Gache au sol du targette - Boccola per fermo della porta - Huls voor vergrendelingsschuif - Vasturaud ukse servariivile		2		